

□150GKA-2

□200GKA-2



OWNER'S MANUAL

No one under the age of 16 should operate this go kart.

Always wear a helmet it could save your life!

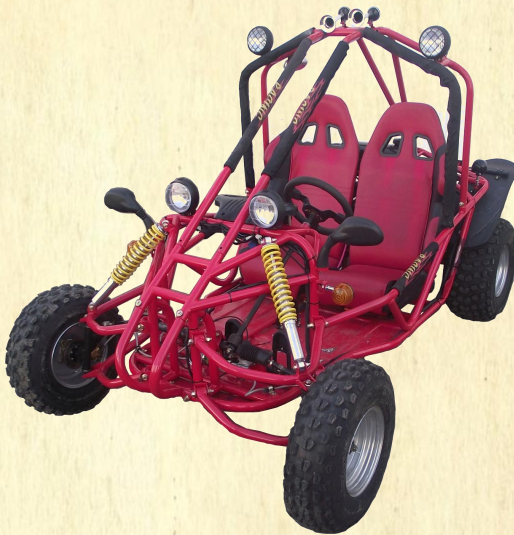

READ THIS MANUAL CAREFULLY!

Provincial / Municipal governments have different regulations pertaining to owning and operating an off-road vehicle, learn the regulations in your area.

To the Owner

Congratulations on your purchase of this Go Kart. This Owner's/Operator's manual will provide you information regarding safe operation, operational instructions, maintenance and care. Fully understanding this manual and following all of the instructions herein will provide the knowledge needed to have safe and enjoyable Go Kart operation.

For questions regarding operation and maintenance of this Go Kart, please contact your dealer.

Safety - Notice to parents

No one under the age of 16 should operate this Go Kart. Not all children have the strength, size, skill, and judgment needed to operate this vehicle safely.

THIS Go Kart IS NOT A TOY AND COULD BE HAZARDOUS TO OPERATE. A Go Kart handles differently from other vehicles including motorcycles and cars. A collision or rollover can occur quickly, even during routine maneuvers such as turning, driving on hills and over obstacles.

Reading the Owner's/ Operator's Manual

It is important this manual is read from cover to cover carefully by the Go Kart owner and all operators. Parents should review the manual carefully with their children. Never allow anyone to operate the Go Kart without first reading and understanding the Owner's/Operator's manual.

This Owner's/ Operator's manual should be a permanent part of the Go Kart and should remain with the vehicle at all times. The manual should also remain with the vehicle if sold.

To emphasize special important information in the manual, please note the following :



This is the alert symbol. The symbol means ATTENTION!, BECOME ALERT!, YOUR SAFETY IS INVOLVED.

To emphasize important safety information, the word WARNING, with the alert symbol, has special meaning.:



Indicates a potential hazard that could result in SEVERE INJURY or DEATH to the operator, bystander or person inspecting or repairing the Go Kart.

To emphasize important information, the word CAUTION has special meaning.:

CAUTION:

Indicates special precautions that must be taken to avoid damage to the Go Kart.

To emphasize important information, the word NOTE has special meaning.:

NOTE:

Indicates key information to make procedures easier or clearer to understand.

WARNING or **CAUTION**

The first part will identify a POTENTIAL HAZARD.

The second part will describe WHAT COULD HAPPEN if the warning or caution is ignored.

The third part will describe HOW TO AVOID THE HAZARD.

This manual is based on the latest product information available at the time of publication. We has a policy of continually improving its products. Due to improvements, or other changes, there may be some discrepancies. We reserve the right to make product changes at any time, without notice and without incurring any obligation to make the same or similar changes to vehicles previously built or sold.

TABLE OF CONTENTS

WARRANTY.....	2	ENGINE OIL	30
IMPORTANT SAFETY LABELS.....	3	CHECKING.....	30
LOCATION.....	3	CHANGING.....	30
LABELS.....	4	CLEANING OIL FILTER	31
SAFETY	6	TRANSMISSION OIL.....	31
DESCRIPTION AND PART LOCATIONS...	7	IDLE SPEED ADJUSTMENT.....	32
DESCRIPTION AND PART FUNCTIONS..	8	SHOCK ABSORBER ADJUSTMENT.....	32
IGNITION SWITCH/IGNITION KEY.....	8	FUEL HOSE INSPECTION.....	33
BRAKE PEDAL.....	8	BRAKES.....	33
GAS PEDAL.....	8	BRAKE FLUID INSPECTION....	33
PARKING BRAKE LEVER.....	8	VALVE CLEARANCE.....	34
FORWARD AND REVERSE LEVER.....	8	FUSE REPLACEMENT.....	34
FUEL TANK CAP.....	9	CHAIN.....	35
OIL FILL PLUG/DIPSTICK.....	9	INSPECTION.....	35
SEAT ADJUSTMENT.....	10	TENSION AND ADJUSTMENT....	35
FUEL AND OIL.....	11	CLEANING AND LUBRICATION...	35
FUEL.....	11	TIRES.....	36
ENGINE OIL.....	11	REPLACING.....	36
BREAK IN.....	12	STORAGE.....	37
PRE RIDE INSPECTION.....	13	RETURNING TO SERVICE.....	37
OPERATING THE GO KART.....	14	WASHING THE GO KART.....	38
WARNINGS.....	14	TRANSPORTING.....	38
HELMET, EYE PROTECTION AND		TROUBLE SHOOTING.....	39
PROTECTIVE CLOTHING.....	15	TORQUE SPECIFICATIONS.....	40
SEAT BELTS.....	16	SPECIFICATIONS.....	41
STARTING THE ENGINE.....	17	SPECIFICATIONS.....	42
STARTING OFF.....	18	CIRCUIT DIAGRAM.....	43
OPERATING ON HILLS.....	19	VEHICLE AND ENGINE NUMBER	
CLIMBING A HILL.....	19	LOCATION.....	44
DESCENDING A HILL.....	19		
TRAVERSING A HILL.....	19		
SKIDDING OR SLIDING.....	20		
OPERATING THROUGH WATER.....	21		
OPERATING IN COLD WEATHER.....	22		
LOAD GUIDELINES.....	23		
AFTER MARKET PARTS.....	23		
MAINTENANCE.....	24		
MAINTENANCE CHART.....	25		
BATTERY INSTALLATION.....	26		
AIR FILTER.....	28		
SPARK PLUG.....	29		

WARRANTY

What this Warranty Does Not Cover

This warranty does not cover the following

1. Damage due to lack or improper maintenance as described in this manual.
2. Damage which is caused by normal use and not caused by a defect in materials or workmanship.
3. Use of the product which is not consistent with the intended use as described in the operating instructions.
4. Any expendable maintenance item which need replacement or service as part of normal maintenance, unless such items have defects in material or workmanship which cause failure or premature wear.
5. Any product which has been altered or modified in a manner not consistent with the original design of the product or in a manner not approved by the company.
6. Tires
7. Damage or failures due to abuse, neglect, or misuse of the product.

Limitations of this Warranty

This warranty does not cover and the company disclaims any responsibility for:

1. Loss of time or loss of use of the product.
2. Transportation costs to and from the authorized center.
3. Other loss or damage to other equipment or personal items.

Length of Implied Warranties

Any implied warranties are limited to the duration set forth in this warranty.

The company does not make any claim as to the merchantability or fitness for a particular purpose which would extend longer than the duration of this written warranty.

Check you State Laws as some State Laws do not allow limitations as to the duration of an implied warranty. Some States may also not allow limitation or exclusions based on incidental or consequential damages.

IMPORTANT LABELS

LOCATION

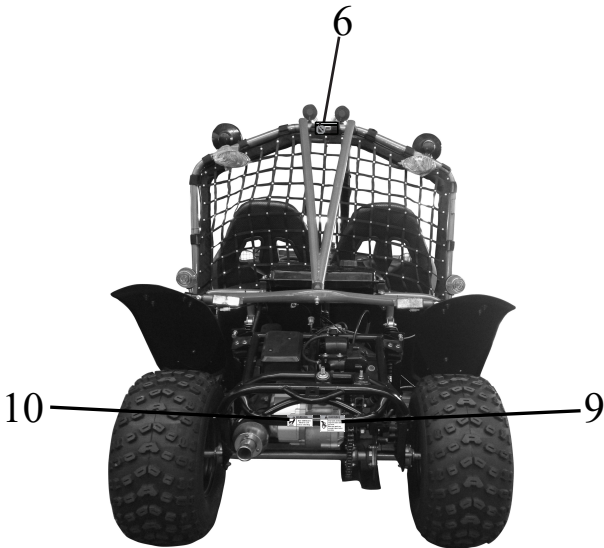
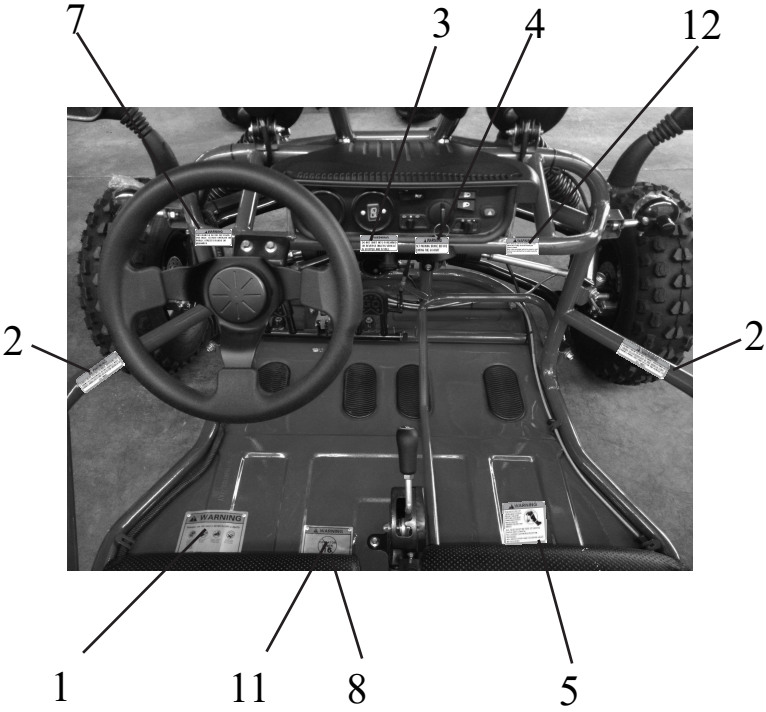

WARNING LABELS

1

⚠ WARNING

FAILURE TO FOLLOW THESE WARNINGS COULD RESULT IN SEVERE INJURY OR DEATH



ALWAYS USE AN APPROVED HELMET AND PROTECTIVE GEAR



NEVER USE ON PUBLIC ROADS



NEVER CARRY MORE THAN ONE PASSENGER. PASSENGER MUST BE SEATED



NEVER USE WITH DRUGS OR ALCOHOL

NEVER OPERATE:

- without first reading and understanding the owner's/operator's manual
- at speeds too fast for your skills or the conditions
- on public roads - a collision can occur with another vehicle
- with more than one passenger - More than one passenger will affect balance and control

ALWAYS:

- be cautious while operating to avoid vehicle overturns on hills, rough terrain and in turns
- avoid paved surfaces - pavement may seriously affect handling and control
- wear seat belts and keep hands, arms and feet in kart at all times

LOCATE AND READ OWNER'S MANUAL.
FOLLOW ALL INSTRUCTIONS AND WARNINGS

2

⚠ WARNING

ALWAYS WEAR SEAT BELTS WHILE OPERATING OR RIDING AS A PASSENGER IN THIS VEHICLE. KEEP HANDS, ARMS, FEET AND LEGS IN THE VEHICLE AT ALL TIMES.

⚠ WARNING

ALWAYS WEAR SEAT BELTS WHILE OPERATING OR RIDING AS A PASSENGER IN THIS VEHICLE. KEEP HANDS, ARMS, FEET AND LEGS IN THE VEHICLE AT ALL TIMES.

3

⚠ WARNING

DO NOT SHIFT INTO FORWARD OR REVERSE UNLESS VEHICLE IS STOPPED AND AT IDLE

4

⚠ WARNING

SET PARKING BRAKE BEFORE EXITING THE GO-KART

5

⚠ WARNING

FAILING TO TIE UP LONG HAIR COULD RESULT IN HAIR GETTING CAUGHT IN MOVING PARTS RESULTING IN SEVERE INJURY OR DEATH

ALL HAIR MUST BE TIED UP ABOVE SHOULDER LENGTH. ALL LOOSE CLOTHING MUST BE SECURED. ALL NECKLACES AND SCARVES MUST BE SECURED



6

⚠ WARNING



DO NOT RIDE ON BACK OF VEHICLE

7

⚠ WARNING

THIS VEHICLE IS FOR OFF ROAD USE ONLY. DO NOT OPERATE ON PUBLIC STREETS ROADS OR HIGHWAYS

8

⚠ WARNING

Improper tire pressure or overloading can cause loss of control. Loss of control can result in severe injury or death.

- Cold tire pressure:
 - Front: 15 ± .5psi (104 ± 3.5kpa)
 - Rear: 15 ± .5psi (104 ± 3.5kpa)
- Maximum weight capacity is 353 lbs. (160 kg)

9

⚠ WARNING



Keep hands and fingers away from chains and sprockets. Make sure guards are securely in place before operation.

10



11

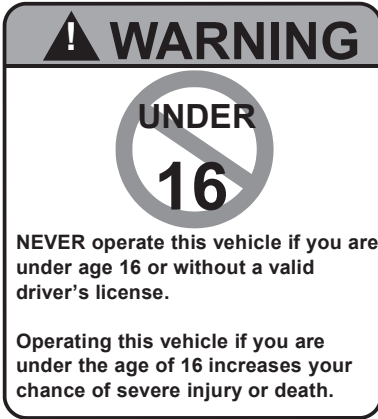

12

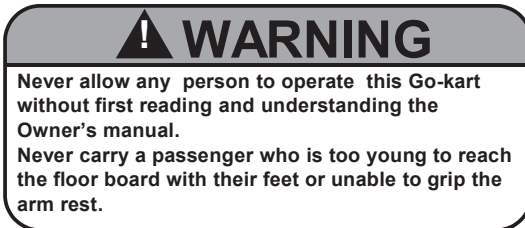

SAFETY

1. Always read and understand the Owner's/Operator's manual and warnings before starting the Go Kart for the first time
2. This Go-Kart should only be assembled by someone who has the knowledge, ability and skills to read and understand mechanical instructions.
3. Use caution when providing maintenance on this Go-Kart. Make sure engine is turned off and all components are cool. Never attempt to make any adjustments while engine is running.
4. Do not modify this Go-Kart in any way, modifications could make the Go-Kart unsafe and/or in violation of Federal and State laws.
5. Never allow anyone under the age of 16 to operate this Go Kart.
6. Always wear a certified DOT certified motorcycle type helmet that fits properly, over the ankle boots, eye protection, gloves, long sleeve shirt and long pants while operating this Go Kart.
7. This Go Kart is designed for one operator and one passenger. Never allow more than one operator and one passenger.
8. Always wear seat belts provided. Make sure seat belts fit properly for both operator and passenger before starting the Go Kart.
9. Never operate this Go Kart on paved surfaces and/or public roads. Pavement may cause the Go Kart to become unstable.
10. The brush guard surrounding the driver and passenger is not intended to provide rollover protection. Before each use, make sure all tubes are securely in place and bolts are tight.
11. Never operate Go Kart with long hair, loose jewelry or loose clothing that could get caught in moving parts.
12. Always go slow on unfamiliar terrain. Be alert to changing terrain conditions when operating the Go Kart.
13. Never take drugs or alcohol before or during operation of this Go Kart.
14. Never attempt jumps or any other type of stunts while operating this Go Kart.
15. Always follow the pre-ride inspection procedures and maintenance procedures located in this manual before use.
16. Always go slow on terrain that is not familiar, be alert, an obstacle could come up unexpectedly.
17. Always keep hands, arms, legs and feet inside the Go Kart at all times.
18. Never operate Go Kart in water that is deeper than 4 inches. Do not operate in fast flowing water. Water can affect braking performance of the Go Kart. Check braking performance after exposure to water, it may be necessary to apply the brakes allowing friction to dry out the pads.
19. Do not attempt to fill the Go-Kart with gasoline while the engine is running or the engine is hot.

DESCRIPTIONS AND PART LOCATIONS

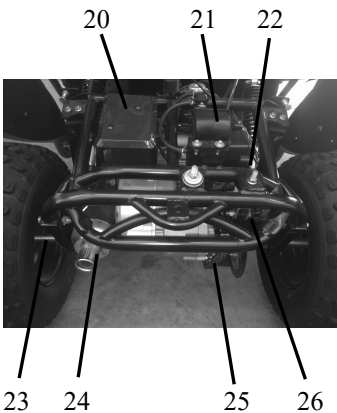
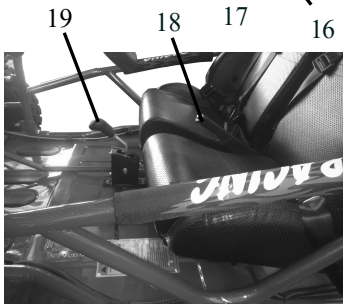
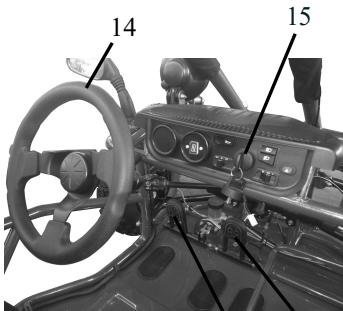
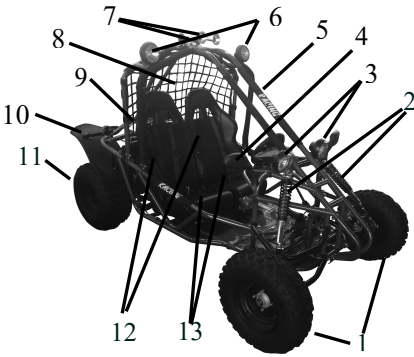

1. Front Wheel
2. Front Shocks
3. headlamps
4. Rear view mirror
5. Brush Guard
6. Dome light
7. Decorating hooter
8. Backup network
9. Fuel Tank
10. Rear fender apron
11. Rear wheels
12. Seat Belts
13. Seat
14. Steering Wheel
15. Ignition Switch
16. Gas Pedal
17. Brake Pedal
18. Parking Brake
19. Shift Lever
20. Electronics cover
21. Air Filter Assembly
22. Parking brake adjustment
23. Rear Axle
24. Muffler
25. Drive Chain
26. Rear brake caliper

DESCRIPTION AND PART FUNCTIONS

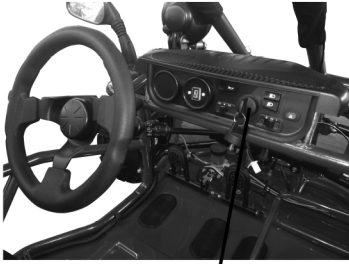

1

Ignitionkey (1): When the ignition switch is placed in the (ON) position the engine can start when apply the foot brake pedal and the ignition key is turned to the right. When the ignition switch is placed in the ○ (OFF) position the engine will not start, or will turn off, if running.

Note: Always make sure the ignition switch (1) is placed in the ○(OFF) position after operation. Leaving the switch (ON) will drain the battery.

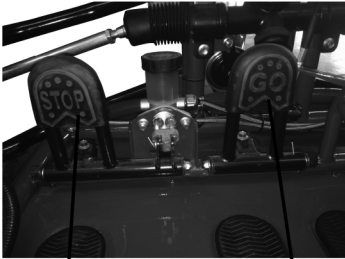

2

3

Brake Pedal (2): Depressing the brake pedal will stop the Go Kart.

Note: Always check brakes before operation

Gas Pedal (3): Depressing gas pedal will increase engine RPMs causing Go Kart to move.



5

4

ParkingBrakeLever (4): Lever pulled to back position will set the parking brake. Always use parking brake when engine is not running or while engine is running and is in a stopped position for an extended period of time.

ForwardandReverselever (5): Lever placed in forward position will allow the kart to move forward. Lever pulled to back position places kart in reverse. Note: Never try to shift Go Kart in Forward or reverse while the Go Kart is moving. Before shifting, make sure kart is stopped and engine is at low idle.

DESCRIPTION AND PART FUNCTIONS

Fuel Cap



Fuel TankCap (1):

To open fuel tank cap, Turn cap counter clockwise to remove. To re-install cap, turn cap clockwise until snug. Make sure cap is seated properly.



Oil Fillplug/Dipstick (2)

To open Oil fill plug/Dipstick, turn cap counter clockwise to remove. To re-install cap, turn cap clockwise until snug. Make sure cap is seated properly

DESCRIPTION AND PART FUNCTIONS

SEAT ADJUSTMENT

WARNING

Failure to have the seat locked in position could be hazardous

The seat coming loose could cause the operator to lose control.

Never operate the Go Kart without the seat locked in place.

1



SeatLatch (1)

The seat latch is located under the driver side seat. To access, look under the front of the driver side seat. Pull the seat latch up to move the seat forward or backward. Before operating the Go Kart make sure the seats are bolted in properly and that the seat latch is locked in place in desired position.

FUEL AND OIL

FUEL

Never use leaded gasoline in this product. It could affect the engine's emissions and damage the engine.

Go Kart requires clean unleaded regular gasoline with a minimum octane rating of 92 or higher.

Gasoline/ Ethanol blends

A blend of unleaded gasoline with Ethanol, also known as GASOHOL, at or below 10% (E10) can be used in your Go Kart.

Ethanol greater than 10% can damage your engine and will void your warranty.

Gasoline/Methanol Blends

A blend of gasoline with Methanol of 5% or less can be used in your Go Kart. Do not use gasoline, under any circumstances, containing more than 5% Methanol, doing so will damage your engine and will void the warranty

Fuel Filling

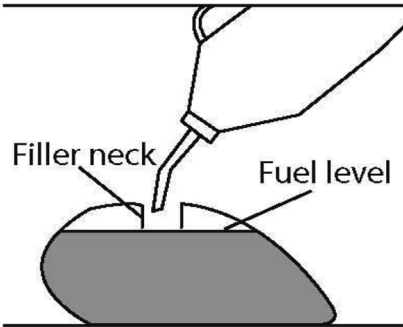

⚠ WARNING

Overfilling the fuel tank can cause the fuel to expand which can cause overflow due to the heat from the engine or sun. Spilled fuel can catch fire.

Never fill the fuel tank above the bottom edge of the filler neck.

⚠ WARNING

Fuel and fuel vapor are highly flammable and toxic. You can be burned or poisoned while refueling.

Before refueling make sure to follow the procedures listed:

- 1 Shut off engine, Make sure there are no flames, sparks or heat sources close by.
- 2 Make sure engine has cooled
- 3 Refuel only outdoors in a well ventilated area.
- 4 Do not smoke while refueling.
- 5 Wipe up any spills immediately.
- 6 Avoid breathing any fuel vapors.
- 7 Keep children and pets away.

ENGINE OIL

The recommended oil for this Go Kart is SAE15W-40 SF motor oil, if this oil is not available, any of the oils on the chart below will work. Note the temperature requirements for each of the oils.

Quantity of oil – 0.95-1qt. (0.9-1L).

TEMP.	C	-30	-20	-10	0	10	20	30	40
	F	-22	-4	14	32	50	68	86	104
ENGINE OIL								20w-50	→
								15w-40	→
								10w-40	→
								10w-30	→

BREAK - IN

BREAK IN PERIOD

The initial 20 hours of operation is most important in the life of your Go Kart. Proper operation during this break in period will help assure maximum life of your Go Kart engine.

The following guidelines will explain the proper break in procedures.

1. During the first 10 hours of operation, do not apply more than 1/2 throttle for long periods of time.
2. During the next 10 hours of operation do not apply more the 3/4 for long periods of time.

Vary the engine speed

Make sure to vary the engine speed during the break in period, this allows the engine to load and unload which helps the parts to seat properly. It is essential to place some stress on the engine during the break in process, however, too much stress could cause damage to the engine components. Be careful not to load the engine too much.

Allow oil to circulate before operating.

Always allow the Go Kart engine to warm up before operating. This allows the oil to circulate throughout the engine which lubricates the components.

Observe your initial and most critical maintenance service

The initial service (break in maintenance) is the most important service for your Go Kart. During the break-in time frame, all of the engine components will have mated together and seated. Maintenance required as part of the initial service includes correction of all adjustments, tightening of all fasteners and replacement of dirty oil. Timely performance of this maintenance will help make sure your Go Kart will have the best service life and performance of the engine.

PRE-RIDE INSPECTION

Inspecting and checking the condition of the Go Kart before each ride is important. Following the pre-ride check list will help insure the you do not have mechanical problems which could result in injury or becoming stranded. Make sure the Go Kart is in good operating condition before each operate.

⚠ WARNING

Failing to inspect and maintain your Go Kart could be hazardous.

Not following the pre-ride inspection procedures could result in loosing control of the Go Kart resulting in an accident or damage to the Go Kart

Always perform a Pre-ride inspection before each operate.

⚠ WARNING

Performing maintenance and checks while the engine is running could be hazardous.

You could be severely injured by moving parts or hot surfaces.

Never perform maintenance or check procedures while the engine is running with the exception of checking the ignition switch or throttle.

WHAT TO CHECK	CHECK FOR
Steering	<ul style="list-style-type: none"> - Smoothness - No restriction of movement
Brakes	<ul style="list-style-type: none"> - Correct fluid level - Inspect hoses for leaks - Inspect brake pads for wear.
Tires	<ul style="list-style-type: none"> - Proper tire pressure - Proper tread depth - Rubber has no cracks
Fuel Tank	<ul style="list-style-type: none"> - Enough fuel for the ride - Fuel cap secure - Hoses have no signs of cracks or leaks
Throttle Pedal	<ul style="list-style-type: none"> - Pedal snaps back to idle when released - Operates freely
Lighting	<ul style="list-style-type: none"> - Proper operation of Head lights and Tail lights.
Engine Ignition switch	<ul style="list-style-type: none"> - Switch shuts off engine when activated.
Engine Oil	<ul style="list-style-type: none"> - Correct oil level
Forward/ reverse lever	<ul style="list-style-type: none"> - No damage - Operates as intended
Drive Chain	<ul style="list-style-type: none"> - Proper tension - Lubricated - No excessive wear or damage
General Condition	<ul style="list-style-type: none"> - All nuts and bolts tight - No rattles from engine or frame while running

OPERATING THE GO KART

WARNING

Carrying more than one passenger on this Go Kart could be hazardous

Carrying more than one passenger could cause loss of control resulting in severe injury or death to the operator and/or passengers.

This Go Kart is designed for one operator and one passenger. Never allow more than one passenger

WARNING

Operating this Go Kart in an irresponsible manner which includes jumping or other stunts could be hazardous.

Jumping or other stunts could result in loss of control of the Go Kart resulting in severe injury or death.

Never attempt stunts, such as jumping.

WARNING

Operating this Go Kart on paved surfaces could be hazardous.

Operating on paved surfaces, including parking lots, sidewalks, driveways and streets can cause loss of control resulting in severe injury or death. Go Kart tires are designed for off-road use only, paved surfaces adversely affect handling and control.

Avoid operating Go Kart on paved surfaces. If you must cross a paved surface, go slow and do not make sudden turns or stops.

WARNING

Operating a Go Kart on hills could be hazardous

Operating a Go Kart on a hill could result in rolling over while traversing, flipping over backwards while climbing, flipping over while descending, general loss of control of the Go Kart. Any of these accidents on a hill could result in severe injury or death.

Never operate a Go Kart on steep hills.

WARNING

Operating this Go Kart on any public road or highway could be hazardous.

You could collide with another vehicle if you operate on public roads or highways resulting in severe injury or death.

Never operate on public roads or highways.

OPERATING THE GO KART

HELMET, EYE PROTECTION, PROTECTIVE CLOTHING

Always wear a DOT certified motorcycle helmet (1). A helmet helps protect against serious head injuries in the event of an accident. A helmet is the most important safety gear item you can wear. Consult with a motorcycle dealer for the correct size and type of helmet that is right for you.

Always wear eye protection when operating a Go Kart such as a face shield or goggles (2). While operating a Go Kart you can be hit in the eyes by any of the following: dust, branches, rocks, debris from other operators, bugs, etc. Good eye protection as well as a helmet and protective operating gear should be mandatory when operating a Go Kart.

Wear protective clothing: Long sleeve shirt (3), Gloves (4), Long pants (5), over the ankle boots (6).

Operating a Go Kart exposes the operator to many hazards, wearing protective clothing can help protect the operator from injury.

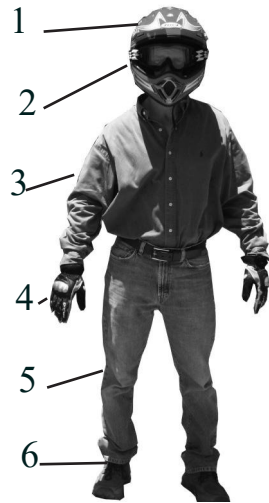

⚠ WARNING

Operating a Go Kart without a helmet, eye protection, and protective clothing can be hazardous

Operating a Go Kart without a helmet increases the chance of severe head injury or death in the event of an accident.

Operating a Go Kart without eye protection such as a face shield or goggles could result in severe injury in the event of an accident.

Operating a Go Kart without protective clothing; closed toe shoes, long pants, gloves, long sleeve shirt could result in severe injury in the event of an accident.

Always wear a Helmet, eye protection, long pants, long sleeve shirt, over the ankle boots and gloves when operating a Go Kart.

OPERATING THE GO KART

SEAT BELTS

⚠ WARNING

Riding in this go kart without the seat belt harness worn and attached properly for both the operator and passenger could be hazardous

Operating the go kart without the seat belt harness worn by both the operator and passenger increases the chance of injury or death in the event of an accident

Never operate or allow a passenger to ride in the go kart without the seat belt harness worn and attached properly.

Never start the go kart without the operator and passenger wearing the seat belt harness in the appropriate manner.

To connect the seat belt harness, properly sit in the seat and place each arm through the shoulder strap (1) on the corresponding side of the harness. After shoulder straps are in place, buckle the lap belt (2) and tighten by pulling the loose ends (3) away from the buckle. Proceed to tighten the shoulder straps by pulling the loose ends (4) towards the bottom of the go-kart.

If there is no passenger in the passenger seat, make sure the passenger seat belt is latched together and secure (5).

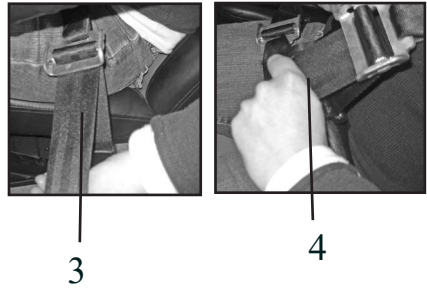
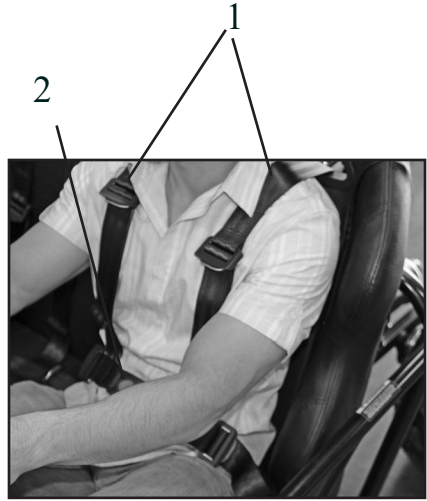

OPERATING THE GO KART

STARTING ENGINE

To start the engine

1. Before starting the engine, ALWAYS REVIEW THE PRE RIDE INSPECTION PROCEDURES LISTED IN THIS MANUAL
2. Make sure parking brake lever (1) is set before attempting to start the engine.
3. Depress foot brake (2)
4. Turn ignition key (3) to the right to activate starter motor.

Note: Do not activate the starter motor more than 5 seconds at a time, doing so could damage the starter.

Note: Do not depress the gas pedal while starting engine, doing so will disengage the choke making it difficult for engine to start

5. Once engine has started, allow engine to warm up 3 to 5 minutes before operating.

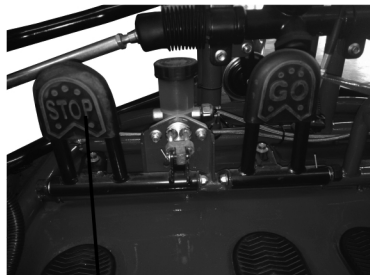

2

WARNING

Starting or running the Go Kart in an enclosed area such as a garage or shed where there is no ventilation is hazardous

Inhaling exhaust fumes from the Go Kart can cause severe injury or death

Never start or run the Go Kart in an inclosed environment where there is no ventilation. Always start and run outdoors.



OPERATING THE GO KART

STARTING OFF

1. Once engine has warmed up, release parking brake by moving parking brake lever (1) to the forward position
2. Let off brake pedal (2) and gradually depress gas pedal (3) until kart moves.
3. Drive kart slowly until you become fully familiar with the Go Karts handling characteristics.



⚠ WARNING

Operating this Go Kart at excessive speeds could be hazardous.

Operating at excessive speeds increases your chances of losing control of the Go Kart, which could result in severe injury or death.

Always go at a speed that is proper for the terrain, visibility, operating conditions, operator skill, and operator experience. Always know the terrain before operating.

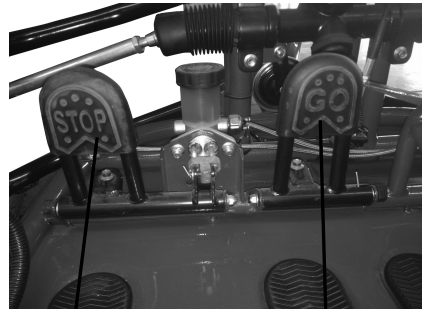

2

3

OPERATING THE GO KART

CLIMBING A HILL

1. Stop and evaluate the hill before attempting to climb. Make sure the hill is not too steep, the terrain is not loose or slippery and that there are no obstacles.
2. Approach the hill at a steady speed and maintain speed throughout the climb.
3. When approaching the top of the hill, slow down.

If it is determined that the Go Kart will not make it to the top of the hill:

1. Do not try to turn the Go Kart around while operating and come back down, this could cause the Go Kart to roll over.
2. Slowly back the Go Kart down the hill while applying the brakes.

If it is determined the Go Kart cannot be backed down the hill safely:

1. Apply the brakes so the Go Kart does not roll backwards.
2. If you feel you would not be able to back the Go Kart down the hill safely, set the parking brake.
3. Carefully dismount the Go Kart.
4. Get help to turn the Go Kart around, always stay uphill of the Go Kart in case it starts to overturn.
5. Re-mount the Go Kart and follow the Descending hill procedures listed in this manual.

DESCENDING A HILL

To operate the Go Kart going down a hill, follow the instructions below.

1. Stop and evaluate the hill before attempting to descend. Make sure the hill is not too steep, the terrain is not loose or slippery and that there are no obstacles.
2. Do not go down the hill on a sharp angle, this could cause the Go Kart to flip over. Instead, go straight down the hill. Apply the brakes on the way down.

TRAVERSING A HILL

WARNING

Traversing a hill could be hazardous.

Traversing a hill could result in losing control and flipping the Go Kart over.

This could result in severe injury or death.

Never attempt to traverse a hill that is too steep or has loose or slippery terrain.

OPERATING THE GO KART

SKIDDING OR SLIDING

In certain situations you may experience skidding or sliding even though the brakes are not applied. Follow the operating techniques listed below to regain control.

Front wheel begins to slide or skid:

To regain traction, let off the throttle, do not apply the brakes.

Rear wheels begin to slide or skid:

To regain traction, let off the throttle and brakes until control of the Go Kart is achieved, steer in the direction of the skid.

WARNING

Skidding or sliding of the Go Kart could be hazardous.

Skidding or sliding could result in the Go Kart sliding into an object or overturning suddenly by regaining traction resulting in severe injury or death.

Avoid skidding or sliding. Drive to stay in control.

WARNING

Applying the parking brake while operating the Go Kart could be hazardous.

Applying the parking brake while operating can cause the wheels to lock up and the Go Kart to slide out of control. The Go Kart could turn over or slide into an object. This could result in severe injury or death.

Apply the parking brake only after the Go Kart has come to a complete stop.

WARNING

Applying the brakes hard on slippery surfaces could be hazardous.

Applying the brakes too hard on a slippery surface can cause the wheels to lock up and the Go Kart to slide out of control. The Go Kart could turn over or slide into an object. This could result in severe injury or death.

Gently apply the brakes when on a slippery surface.

OPERATING THE GO KART

OPERATING THROUGH WATER

Operating through water can be hazardous, especially if it is fast moving. Make sure the water you are operating through is shallow and is not more than 10cm (4in) deep. Before crossing any water look at the terrain entering and exiting the water, the terrain should have a gradual slope with no obstacles. The bottom of the river or pool of shallow water should be hard. If you do not know the terrain or are not sure about the bottom of the pool or river, do attempt to enter. Remember to protect the environment, do not enter a river or pool of water if doing so could damage the river bank or shore line.

Brakes need to be inspected, cleaned and replaced more often if Go Kart is used in muddy, wet or sandy conditions. Inspect the Go Kart brakes regularly, have a service center clean or replace as needed.

WARNING

Operating this Go Kart through fast or deep water could be hazardous;

Deep or fast moving water could cause the Go Kart to lose traction resulting in loss of control which could lead to severe injury or death.

Never operate this Go Kart in water that is more than 10cm (4in) deep. Never operate this Go Kart in fast moving water.

Always check brakes after operating through water, wet brakes can reduce stopping ability.

Make sure brakes are dried out. The brakes can be dried out from friction by applying the brakes multiple times.

OPERATING THE GO KART

OPERATING IN COLD WEATHER

PRE RIDE INSPECTION

Brake and throttle linkages:

Cold weather requires additional pre-ride inspection of the Go Kart before operating. Inspect brake and throttle linkages making sure they operate freely and correctly. Ice and snow can cause these items to freeze. If the linkages are frozen, move the Go Kart to a warm area until these items thaw and work properly.

Frozen tires:

Check to make sure the Go Kart tires are not frozen to the ground, if they are, pour warm water around the tires to release. Do not attempt to break the Go Kart loose using engine power, this could damage the engine and drive train.

Brake inspection:

Start engine and allow to warm up. Check the braking ability of the Go Kart by applying the brakes on level ground while traveling at a slow (walking rate) of speed. Make sure both front and rear brakes work properly.

If the front, rear, or both sets of brakes do not work, take the Go Kart to a warm area to thaw out. Once brakes are thawed, check again for proper operation, if they still do not work, take the Go Kart to a authorized service center. Do not attempt to operate the Go Kart with brakes that do not work correctly,

Preventive maintenance in cold weather operating is important, after operating in cold weather with snow, slush, water or ice, dry off the Go Kart including brake and throttle linkages. Apply the brakes several times making sure that the friction has dried off the brake pads and shoes. Cover the Go Kart with a protective cover so ice and snow cannot accumulate.

CAUTION

Using engine power to release wheels that are frozen to the ground could damage Go Kart.

Damage to engine and drive train may occur if attempting to use engine power to free frozen wheels.

Always make sure wheels move freely before starting the Go Kart in cold weather.

WARNING

Operating the Go Kart with wet or frozen brakes could be hazardous.

Wet or frozen brakes will increase stopping distance which could result in loss of control which could result in severe injury or death.

Always inspect the brakes before each ride by following the procedures in this manual.

OPERATING THE GO KART

LOAD GUIDELINES

Load guidelines including accessories:

Never exceed the maximum load capability of the Go Kart. This includes the weight of the operator and any cargo. This Go Kart is rated at 353 lbs. (160kg).

The cargo rack is rated at 25 lbs (11.34kg)

Make sure all cargo is secure as well as the connection points on the rack. Distribute the weight of cargo evenly and low so the center of gravity is not adversely affected.

Do not add any accessory or cargo to the steering wheel that could impede vision or make the Go Kart harder to steer.

Make sure accessories do not get in the way of any controls of the Go Kart.

Only carry cargo that is not bulky or too heavy.

Make sure all cargo is held securely in place, loose cargo can become a hazard.

While carrying cargo, go slow. Cargo can adversely affect handling at higher speeds

Allow plenty of distance to stop while carrying cargo, The more weight on the Go Kart, the longer distance it will take to stop.

AFTER MARKET PARTS

After market parts and accessories are available from many manufactures. We cannot confirm the quality, safety or suitability of all the accessories available. When purchasing an accessory, use caution, the handling of the Go Kart could become affected. Some accessories may make the Go Kart unsafe to operate. If you have a question about a modification or accessory, contact your dealer.



WARNING

Operating this Go Kart with modifications or adding accessories could be hazardous.

Modifications to the Go Kart, including adding accessories, could adversely affect the handling of the Go Kart causing an accident which could result in severe injury of death.

Never Modify this Go Kart in anyway, including adding accessories, unless the modification is a genuine certified modification or accessory approved by the manufacture.

Never modify the Go Kart with improper installation. Make sure to follow all instructions recommended in the certified modification. Use only genuine parts.

MAINTENANCE

For maintenance, your Go Kart may be maintained by an authorized original manufacturer service dealer or a repair shop of your choosing.

Following the proper maintenance procedures and time table for maintenance listed in this manual is

important for the safety of the operator and the life span of the Go Kart. When operating in harsh conditions, such as water, mud and dust, the maintenance procedures should be performed more often.

WARNING

Failing to perform the recommended maintenance on this Go Kart could be hazardous.

Failing to perform proper maintenance on this Go Kart could result in an accident

Always perform the recommended maintenance for the Go Kart as listed in this manual.

WARNING

Performing maintenance and inspection while the engine is running could be hazardous.

Performing maintenance and inspections while the engine is running could result in getting body parts or clothing caught in moving parts, or could result in touching hot items which could result in severe injury.

Shut off engine when performing maintenance and inspection checks, with the exception checking the ignition switch and throttle.

CAUTION

Failing to perform recommended maintenance on this Go Kart could damage the Go Kart engine and components.

Always perform the recommended maintenance on this Go Kart as listed in this manual.

Maintenance will need to be performed more often if ridden in wet, muddy or dusty conditions.

CAUTION

Failing to use compatible parts with the original replacement parts could damage Go Kart.

Using parts that are of low quality could result in Go Kart breakdowns and reduce the useful life of the Go Kart.

Never use parts that are not compatible with the original parts.

MAINTENANCE CHART

ITEM	First 5 hours of operation	Before each ride	Every 20 hours of operation or 1 month	Every 50 hours or 3 months	Every 100 hours or 6 months
Exhaust pipe nuts and muffler bolts	T	I	T		
Air cleaner element	I		I		
Valve Clearance**					I
Spark Plug			I		R
Fuel Line		I			
Idle speed	I		I		
Condition of throttle and brake cables	I	I			
Engine oil	R	I		R	
Oil filter screen	I			I	
Transmission oil					R
Drive Chain	Inspect drive chain before each ride. Clean and lubricate as necessary				
Brakes	I		I		
Brake hose	I		I		
Brake fluid	Inspect brake fluid level before each ride, if low, check brake pads for wear and brake lines and components for leaks. Replace brake fluid every 2 years.				
Tires		I			
Steering	I		I		
Front suspension	I		I		
Rear suspension	I		I		
Chassis nuts and bolts	T	I	T		

** Recommended to be performed by an authorized service center or service center of the owner's choosing.

NOTE: I= INSPECT AND CLEAN, ADJUST, REPLACE OR LUBRICATE AS NECESSARY,
R=REPLACE, T = TIGHTEN

BATTERY INSTALLATION AND MAINTENANCE

WARNING

Battery electrolyte (Sulfuric Acid) is poisonous, electrolyte can cause severe burns if contacts skin. Avoid contact with skin, eyes or clothing.

If sulfuric acid is swallowed or splashed in the eyes, treat immediately. Sulfuric acid in the eyes can cause blindness. Serious internal injuries or death can result if swallowed.

ANTIDOTES: For acid on the skin, flush with water.

If acid is swallowed drink large quantities of milk or water, followed by milk of magnesia, vegetable oil or beaten eggs. Do not induce vomiting. Call a poison control center or doctor immediately. For acid in the eyes, flush for several minutes with water and seek immediate medical attention.

Make sure work area is well ventilated.

Always wear goggles or face shield when working with the battery.

Always wear protective plastic gloves to protect hands

Always wear a protective smock to protect clothing.

Battery preparation

1. Remove battery (1) and electrolyte bottle (2) from box. Remove battery cap strip (3) from electrolyte bottle



2. Pull tape strip (4) off top of battery and discard.



3. Turn electrolyte bottle over and place on top of battery pushing firmly until the battery nozzle tips puncture the film over the spouts. Allow all electrolyte to flow into the battery.



Note: Dispose of electrolyte bottle properly

4. Install battery cap strip (3). Let battery sit for 1/2 hour before charging.



Note: The battery is a sealed type battery once the cap is in place. there is no maintenance to fluid level. Never re-open once caps are in place.

CHARGING THE BATTERY

Note: Do not turn the charger on before attaching the charger clips to the battery terminals.

The standard charging rate is $0.7A \times 5 - 10$ hours. Maximum charging rate is $3A \times 1$ hour

1. Attach the Charger to the battery terminals. Red clip to the POS + side of the battery. Black clip to the NEG - side of the battery.
2. Plug in the charger and turn on making sure it is set at the correct settings.
3. Once battery is charged, unplug the charger before disconnecting the POS + and NEG- clips

CAUTION

Reversing the battery lead wires can damage the charging system and the battery.

The red lead (clip) must go to the POS (+) side of the battery. The black lead (clip) must go to the NEG (-) side of the battery.



! WARNING

If not performed the correct way, charging the battery could be hazardous.

While charging battery, keep away from sparks and open flames. The battery gives off explosive gasses.

Always connect the charger to the battery before turning the charger on, this will prevent sparks when attaching the terminal clips to the battery.

Always unplug the charger before disconnecting the battery from the charger, this will prevent sparks when removing the terminal clips from the battery.

Installing the battery

1. Install battery (1) behind the passenger seat of the Go Kart.
2. Attach the red wire to the POS + side of the battery. Attach the black wire to the NEG - side of the battery. Make sure the connections are tight.
3. Install battery protective cap (2) and rubber strap (3) to hold battery in place.



MAINTENANCE

AIR FILTER

The air cleaner element needs to be cleaned or replaced periodically (see chart for cleaning/replacement intervals). The air filter element will need to be cleaned more often if Go Kart is ridden in muddy, wet, or dusty conditions. A clean air filter will help the Go Kart to run at peak performance allowing better gas mileage, more power and will protect the engine from the damaging effects of dirt entering the engine.

AIR FILTER REMOVAL, INSPECTION AND CLEANING

1. Locate the air filter assembly attached to carburetor. Remove filter element by loosening and removing screws (1)
2. Remove the foam element (2) from inside the cleaner housing. Inspect element, if torn or if element shows signs of wear, replace.
3. Clean foam element with warm soap and water (3) then squeeze out excess water (5) and allow to dry completely.
4. Place a small amount of air filter oil on the foam element (4). Wring out any excess oil (5)
5. Re-install element into housing and re-attach to air filter assembly

CAUTION

Clean air filter more frequently if Go Kart is driven in wet, muddy or dusty conditions.

Driving in the above conditions without cleaning frequently can plug up the air filter which can cause poor gas mileage, low power and cause damage to the engine.

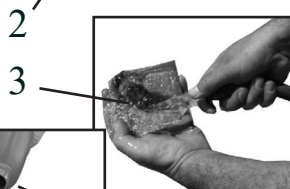
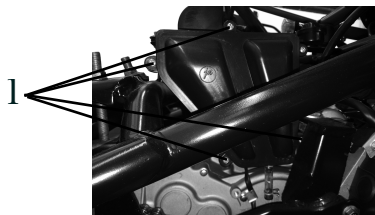

MAINTENANCE

SPARK PLUG

This Go Kart comes equipped with an A7TC spark plug.

To inspect the spark plug, remove the plug cap (1) then remove the spark plug (2) from the engine with the spark plug tool provided.

Inspect the plug for carbon deposits and clean if necessary with a wire brush. If plug shows excessive carbon, replace the plug.

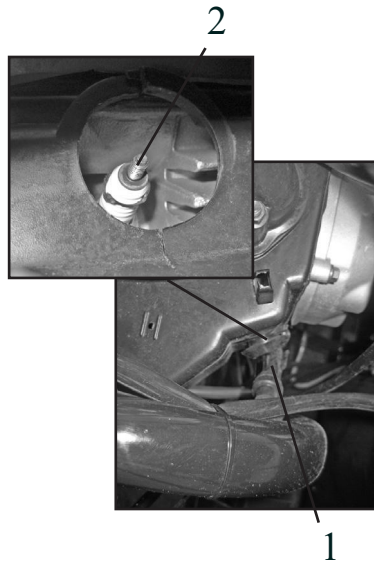

CAUTION

Dirt can damage the engine if it enters the spark plug hole.

Make sure the spark plug hole is covered after removing plug.

Use a thickness feeler to inspect the spark plug gap (2). The spark plug gap should be 0.6 - 0.7mm (0.024 - 0.028 in.)

Re-install the inspected plug or a new plug until finger tight. Finish tightening plug with a wrench. If spark plug is a new plug, tighten approximately 1/2 turn more with the wrench. If plug is an old plug, tighten approximately 1/8 turn more with a wrench.

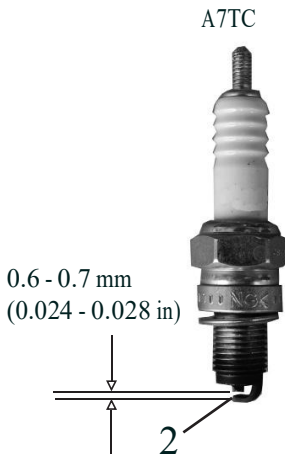

MAINTENANCE

ENGINE OIL

The proper amount and grade of engine oil will have a great impact on the life of the engine. Checking the oil daily and changing the oil as listed in the maintenance schedule is the most important maintenance procedure there is for the engine.

CHECKING THE ENGINE OIL

1. Make sure the Go Kart is on level ground
2. Check engine oil level by removing and looking at the oil plug/dipstick (1). Oil should be close to the top of the serrated portion of the dipstick.
3. If engine oil is low, add oil until oil is at the top of the serrated portion of the dipstick. Use the correct grade of oil as listed in this manual. Do not over or under fill engine with oil, this could damage the engine.

CHANGING THE ENGINE OIL

1. Make sure engine is warm before attempting to drain the oil. A warm engine will help the oil drain quicker.
2. Remove the oil fill plug (1)
3. Remove the drain bolt (2) located on the bottom of the engine.
4. Allow the oil to drain in an appropriate container. Note: Dispose of oil at an oil reclaim facility.
5. Install the drain plug and fill with the appropriate type of oil as listed in this manual. This Go Kart requires 0.95-1qt. (0.9L-1L) of engine oil.
6. Re- install fill cap, Start engine and allow to run for a few minutes, Re-check oil level and fill accordingly.

⚠ WARNING

New and used oil can be hazardous
Children and pets can be harmed
by swallowing new or used oil.
Continuous contact with used
engine oil has been found to cause
skin cancer in laboratory animals
Always keep new or used oil away
from children and pets.



1

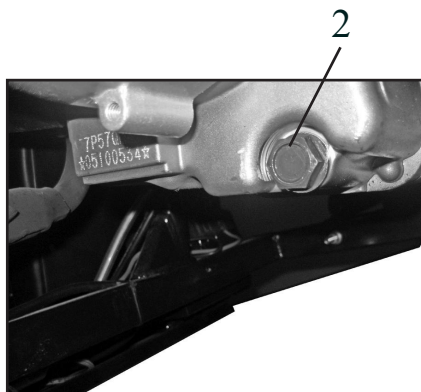

2

MAINTENANCE

CLEANING OIL FILTER SCREEN

1. Remove oil drain plug (1) located on bottom left side of engine and drain oil in an appropriate container. Once oil is drained, re-install drain plug (1)
Note: Always dispose of used oil at an oil reclaim facility.

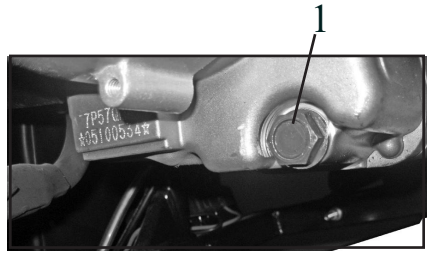

2. Locate and remove Oil filter screen plug (2) located on bottom of engine.

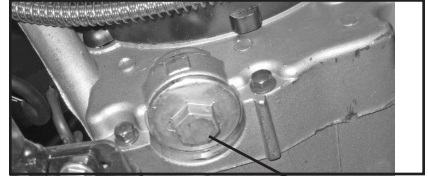

3. Remove screen (3) from oil filter plug assembly.

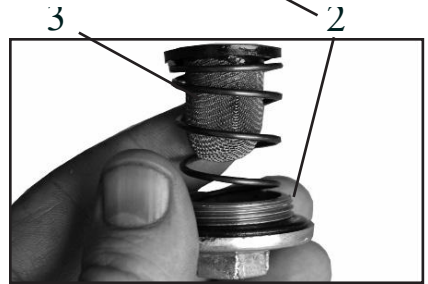

4. Clean screen (3) as well as the inside of Screen plug (2) with soap and water. Allow to dry completely.

5. Re install oil filter screen and re-fill engine with the proper amount and grade of engine oil.

TRANSMISSION OIL

Go kart is sent from the factory with the correct transmission oil type and quantity. Refer to maintenance schedule for oil change intervals.

Checking the level of transmission oil can only be done by draining and replacing with the correct oil type and quantity.

1. Locate and remove transmission oil fill plug (4) located on bottom side rear portion of engine assembly.

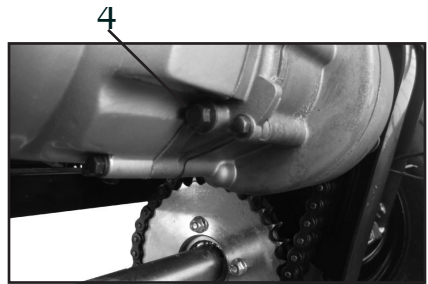

2. Locate and remove transmission oil drain plug (5) located on bottom back portion of engine assembly.



3. Drain transmission oil in an appropriate container then re-install drain plug (5) Note: Dispose of used oil at a oil reclaim facility.

4. Fill until oil starts coming out of fill hole (approx. 13 oz.) with fresh clean 85w-90 gear oil.

MAINTENANCE

IDLE SPEED ADJUSTMENT

The idle speed should be set at 1700 \pm 100 RPMs

To adjust the idle speed:

1. Locate the idle adjustment screw (1) located on the carburetor.
2. Allow the engine to warm up approximately 10 minutes
3. With the engine running, turn the idle adjustment screw in or out at small increments until the correct idle is achieved.

Note: A service center can perform this adjustment. A diagnostic tachometer is required for this adjustment.



SHOCK ABSORBER ADJUSTMENT

The front and rear shocks each have five adjustable positions. The default position has been set by the manufacture. The tension of the shock will change depending on the position of the adjustment ring (2). To increase to a stiffer suspension, rotate the adjustment ring counter clockwise. To decrease to a lighter suspension, turn adjustment ring clockwise. Generally heavier riders will want suspension adjusted to a stiffer position so the shocks will not bottom out while going over bumps.

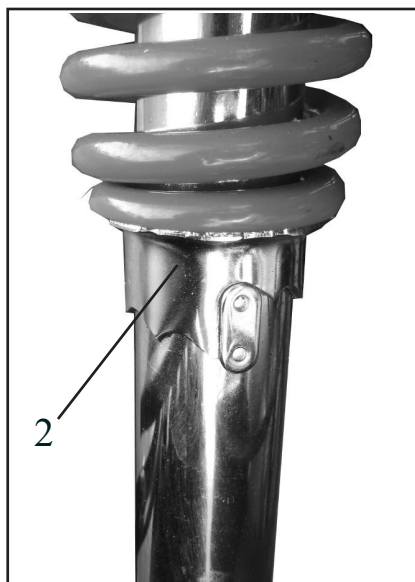

Do NOT attempt to operate this kart if the shocks in the front are not adjusted to the same settings, or if the shocks in the back are not adjusted to the same settings.

MAINTENANCE

FUEL HOSE INSPECTION

Inspect the fuel hose (1) for any cracks or leaks and make sure all clamps are in place. Replace the fuel hose if any defects are found.

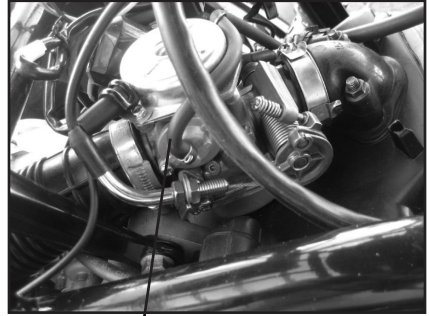

1

BRAKES

This Go Kart is equipped with front and rear hydraulic disk brakes

WARNING

Failing to inspect brakes before each use could be hazardous

Inspect brakes before each use according to the Pre ride check list, make sure to follow the maintenance schedule and procedures.

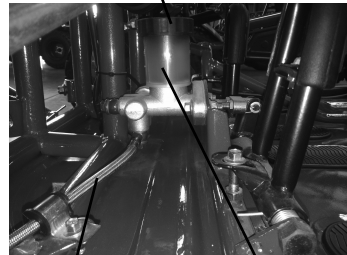

4

3

2

BRAKE FLUID INSPECTION

Check the brake fluid level (2) for front and rear brakes. If fluid level is below the lower mark, inspect the brake hoses (3) for leaks or cracks. If there are no leaks, inspect the brake pads for excessive wear. If brake pads are worn, take to a service center for replacement.



3

To add brake fluid, remove the lid (4).
Use only DOT3 or DOT4 brake fluid

MAINTENANCE

VALVE CLEARANCE

Adjusting the valves should be done by an authorized service center or comparable servicing dealer. Proper valve gap will help keep Go Kart running at peak performance. Follow the valve gap adjustment intervals listed in the maintenance chart.

Proper Valve Clearance

Intake: 0.002 in (0.05mm)

Exhaust: 0.003 in (0.0762mm)

FUSE REPLACEMENT

If starter motor does not turn over, it may be the 15 amp fuse is bad.

To access 15 amp fuse, remove electronics cover (1) located on top of engine assembly.

Locate and open fuse holder (2).

Inspect fuse (3), if damaged, replace.

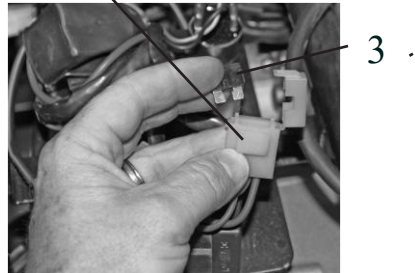
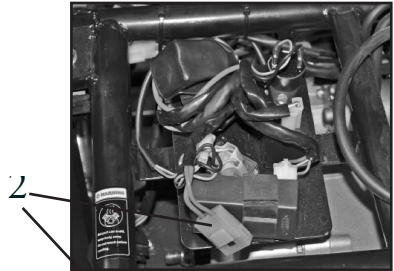
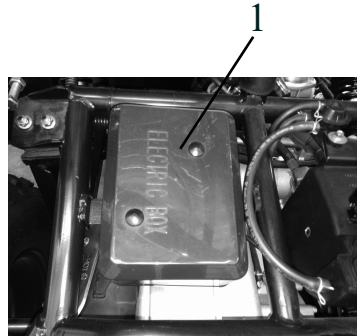

MAINTENANCE

CHAIN

CHAIN AND SPROCKET INSPECTION

Inspect drive chain for wear, rust, bound links, proper lubrication and proper tension.

If drive chain has a problem, correct or replace. Contact a service center for chain replacement.

A worn drive chain could also mean the sprockets may be worn.

Look for the following on sprockets (1): Worn teeth, broken or damaged teeth, loose sprocket mounting nuts.

If sprockets show signs of wear, contact a service center for replacement.

CHAIN TENSION

⚠ WARNING

Checking chain tension while the engine is running could cause serious injury.

Always make sure engine is off before checking drive chain tension.

Check tension of drive chain (2), chain tension should be 5 - 15mm (0.2 - 0.6in)

Chain tension (slack) Adjustment

1. Loosen jam nuts (3) on Chain tensioners (4)
2. Adjust chain tension by turning tensioner nuts (5). Clockwise will tighten the chain. Counter clockwise will loosen the chain.
3. Once the chain is at the correct tension re-tighten Jam nut (3).
4. Re-check chain tension.

CHAIN LUBRICATION

Lubricating the chain before each ride will help to ensure maximum life of the chain and sprockets.

Instructions for cleaning and chain lubrication:

1. Clean chain with warm soap and water and allow to dry.
2. Lubricate chain with chain lube.

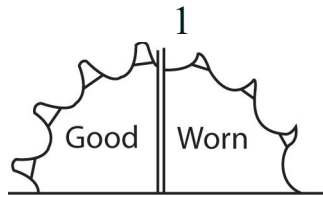

5 - 15mm

(0.2 - 0.6in)

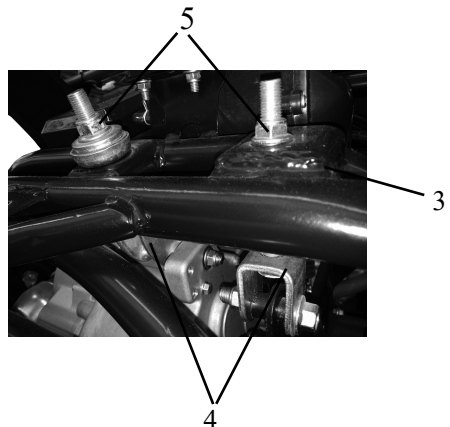
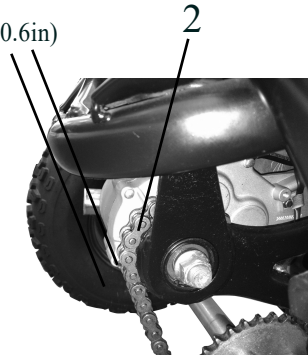

MAINTENANCE

TIRES

Inspect tires before each ride, this should include the following:

1. Inspect for cracks or leaks
2. Inspect tread depth. If tread depth is below 4mm (.16 in.) replace the tire.
3. Check tire pressure. Incorrect tire pressure can affect the handling, operator comfort, steering, tire life and traction. Always check the tire pressure before each ride.

Tire pressure

Front tires: 15psi (103.5Kpa)

Rear tires: 15psi (103.5Kpa)

Tire size:

Front tires: AT 21 × 7-10

Rear Tires: AT 22 × 11-10

REPLACING TIRES

Always replace tires with type and size listed in this manual.

Always use the correct tools when replacing tires. The bead and sometimes the rim can be damaged by using the wrong type of tools. It is usually best to have tires replaced by an authorized service center. Service centers have the correct equipment and expertise to change tires without causing damage.

Punctures to tires can usually be repaired by using plug type patches. Plug type patches cannot repair tires that have been cut. If the tire has been cut or has a puncture in a location or size that cannot be repaired, replace the tire.

Be prepared for flat tires, always carry a plug type patch kit and air pump with you.



Minimum tread
4mm (.16 in.)



WARNING

Operating this Go Kart with worn tires could be hazardous

Operating this Go Kart with worn tires will reduce traction which could result in an accident.

Never operate this Go Kart with tires that have a tread depth of less than 4mm (0.16 in.)

WARNING

Operating this Go Kart with improper tire sizes or pressure could be hazardous

Operating this Go Kart with improper tire sizes or pressure could result in loss of control of the Go Kart which could result in an accident.

Never operate this Go Kart with improper tire sizes or pressure.

MAINTENANCE

STORAGE

If the Go Kart is left unused for an extended period of time proper storage maintenance is required.

1. Wash Go Kart thoroughly, then wax plastics and painted parts with a non abrasive auto wax. Coat vinyl seat and rubber parts with a vinyl/rubber protectant.

Note: Keep water away from air intake and muffler outlet while washing to avoid water from entering the engine and/or components.

2. Drain carburetor by opening drain screw (1) which is located on the carburetor. Allow all fuel to drain from the carburetor. Once fuel is drained, re-tighten drain screw (1).

Note: Make sure to drain fuel in a proper storage container.

3. Fill fuel tank to full with gasoline mixed with fuel stabilizer as recommended by the fuel stabilizer manufacture. Note: Fuel stabilizer can be purchased at most motorcycle shops and auto parts stores.

4. Remove spark plug and pour 1 tablespoon of motor oil in the spark plug hole. Re-install spark plug.

5. Turn the starter key and allow the Go Kart turn over a few times. If Go Kart starts, shut off immediately. This is to coat the inside cylinder head with oil.

6. Cover the muffler outlet and air intake with oily rags so the Go Kart will be protected from humidity in storage.

7. Remove the Battery and clean battery case and terminals with soap and water. Store battery in a cool dark place. Charge battery at least once a month while in storage.

8. Fill tires with correct air pressure.

9. If possible, store Go Kart in a shed or garage with a cover to protect from dust, dirt and humidity. If the Go Kart must be stored outdoors, cover Go Kart completely with a good waterproof cover.

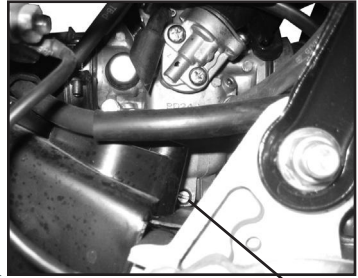

1

Returning to service

1. Wash Go Kart thoroughly.

Note: Keep water away from air intake and muffler outlet while washing to avoid water from entering the engine and/or components.

2. Remove oily rags from air intake and muffler outlet.

3. Drain engine oil and replace with fresh clean oil as listed in this manual.

4. Charge battery and install.

5. Review this owner's manual and follow the pre-ride inspection procedures.

6. Start engine by following the starting procedures in this manual.

MAINTENANCE

WASHING THE GO KART

1. Wash mud and dirt off Go Kart with low water pressure from a hose.
2. Wash Go Kart using a mild detergent or car soap using a sponge, soft rag or brush. Do not use any cleaning materials that could scratch the Go Kart.

Note: Be careful not to allow water to enter the muffler outlet, air filter intake, brake cables or switches.

TRANSPORTING

1. Open the drain screw (1). Allow all fuel to drain from the carburetor. Once fuel is drained, re-tighten drain screw (1).

Note: Make sure to drain fuel in a proper storage container.



2. Transport the Go-Kart in the upright position tied down securely.

TROUBLESHOOTING

Trouble	Possible cause	Solution
Engine will not start - Starter motor does not turn over	<ul style="list-style-type: none"> - Fuse is burned out - Battery terminal is loose - Starter motor not working 	<ul style="list-style-type: none"> - Replace fuse - Tighten terminal - Take to a service center
Engine will not start - Starter motor turns over	<ul style="list-style-type: none"> - Air filter dirty - Low fuel - Stale (old) or contaminated fuel. - Fuel valve is defective - Clogged fuel filter - Loose spark plug - Spark plug fouled or defective. - Spark plug gap is incorrect - Spark plug cap is not attached - Trying to start engine while applying throttle - Low compression - Problem with the electrical system 	<ul style="list-style-type: none"> - Clean or replace air filter - Fill with fresh fuel - Have a service center flush and fill with fresh fuel. - Replace fuel valve - Replace fuel filter - Tighten spark plug - Clean or replace plug - Gap the plug - Attach spark plug cap - Do not apply throttle while starting, doing so disengages auto choke - Take to a service center for repair - Take to a service center for diagnostics and repair
Engine stalls or runs erratically	<ul style="list-style-type: none"> - Air filter dirty - Low fuel - Stale or contaminated fuel - Spark plug is fouled or defective - Spark plug gap is incorrect - Spark plug cap is loose - Carburetor is clogged or has water in it - Idle is not adjusted properly - Problem with the electrical system - Low compression 	<ul style="list-style-type: none"> - Clean or replace air filter - Fill with fresh fuel - Have a service center flush and fill with fresh fuel. - Clean or replace plug - Gap the plug - Secure the spark plug cap - Take to a service center - Take to a service center - Take to a service center for diagnostics and repair - Take to a service center for repair

TORQUE SPECIFICATIONS

FASTNER THREAD SIZE	TORQUE (ft.lbs.) / (in.lbs.)	TORQUE (nm)
5 mm bolts and nuts	39-52 in.lbs.	4.5 - 6 nm
6 mm bolts and nuts	69 - 104 in. lbs.	8 - 12 nm
8 mm bolts and nuts	13 - 18 ft.lbs.	18 - 25 nm
10 mm bolts and nuts	22 - 29 ft.lbs.	30 - 40 nm
12 mm bolts and nuts	36 - 43 ft.lbs.	50-60 nm
4 mm screws 22-30	22 - 30 in.lbs.	2.5-3.4 nm
5 mm screws	30 - 43 in.lbs.	3.5 - 5 nm
6 mm hex bolts	87 - 121 in.lbs.	10 - 14 nm
8 mm hex bolts	17 - 22 ft.lbs.	24 - 30 nm
10 mm hex bolts	25 - 32 ft.lbs.	35 - 45 nm

□150cc

SPECIFICATIONS

Engine

Displacement 149.6cc
Starting Electric
Spark Plug Type A7TC
Cooling Air cooled
Engine Oil Capacity 0.95-1qt.
(0.9L-1L)
Engine Oil Type SAE 15W-40 SF
Transmission oil Capacity 13oz.
Transmission oil 85W-90 gear oil
Ignition Type CDI
Number of Cylinder Single
Combustion Cycle 4-stroke
Compression Ratio 10.3:1
Bore and Stroke 57.4x57.8mm
Horse Power (HP) 7.5/7000 RPMHP
Rated Power 5.5Kw/7000rpm
Max Torque 8.3N.m/6000rpm
Top Speed 37.28mph (60km/h)

Transmission

Type CVT
with forward and reverse
Drive System Type Chain Drive
Gear Ratio Automatic

Suspension

Front Type Double A-arm
Rear Type Double shock
Shock Type Front Hydraulic
Shock Type Rear Hydraulic

Braking

Brakes Front and Rear Hydraulic
disk

Tires

Front Tire Size AT21X7-10
Rear Tire Size AT22X11-10
Tire pressure 15psi (103.5kpa)

Dimensions and Weights

Length 96.5in (2450mm)
Height 62.2in. (1580mm)
Width 59.5in. (1510mm)
Wheelbase 74.3in. (1885mm)
Vehicle Wt. 562.2lbs (255kg)
Weight Cap. 353lbs (160kg)

Fuel

Gas Tank Capacity 1.59gal. (6L)
Fuel type Unleaded 92 octane
or higher

Battery

Battery Type 12V9Ah
Fuse 15 amp

□200cc

SPECIFICATIONS

Engine

Displacement 177.3cc
Starting Electric
Spark Plug Type A7TC
Cooling Air cooled
Engine Oil Capacity 0.95-1qt.
(0.9L-1L)
Engine Oil Type SAE 15W-40 SF
Transmission oil Capacity 13oz.
Transmission oil 85W-90 gear oil
Ignition Type CDI
Number of Cylinder Single
Combustion Cycle 4-stroke
Compression Ratio 10:1 Bore
and Stroke 62.5x57.8mm Horse
Power (HP) 8.8/7000 RPMHP Rated
Power 6.5Kw/7000rpm Max
Torque 10N.m/6000rpm Top
Speed 37.28mph (60km/h)

Transmission

Type CVT

with forward and reverse

Drive System Type Chain Drive
Gear Ratio Automatic

Suspension

Front Type Double A-arm
Rear Type Double shock
Shock Type Front Hydraulic
Shock Type Rear Hydraulic

Braking

Brakes Front and Rear Hydraulic
disk

Tires

Front Tire Size AT21X7-10
Rear Tire Size AT22X11-10
Tire pressure 15psi (103.5kpa)

Dimensions and Weights

Length 96.5in (2450mm)
Height 62.2in. (1580mm)
Width 59.5in. (1510mm)
Wheelbase 74.3in. (1885mm)
Vehicle Wt. 562.2lbs (255kg)
Weight Cap. 353lbs (160kg)

Fuel

Gas Tank Capacity 1.59gal. (6L)
Fuel type Unleaded 92 octane
or higher

Battery

Battery Type 12V9Ah
Fuse 15 amp

CIRCUIT DIAGRAM

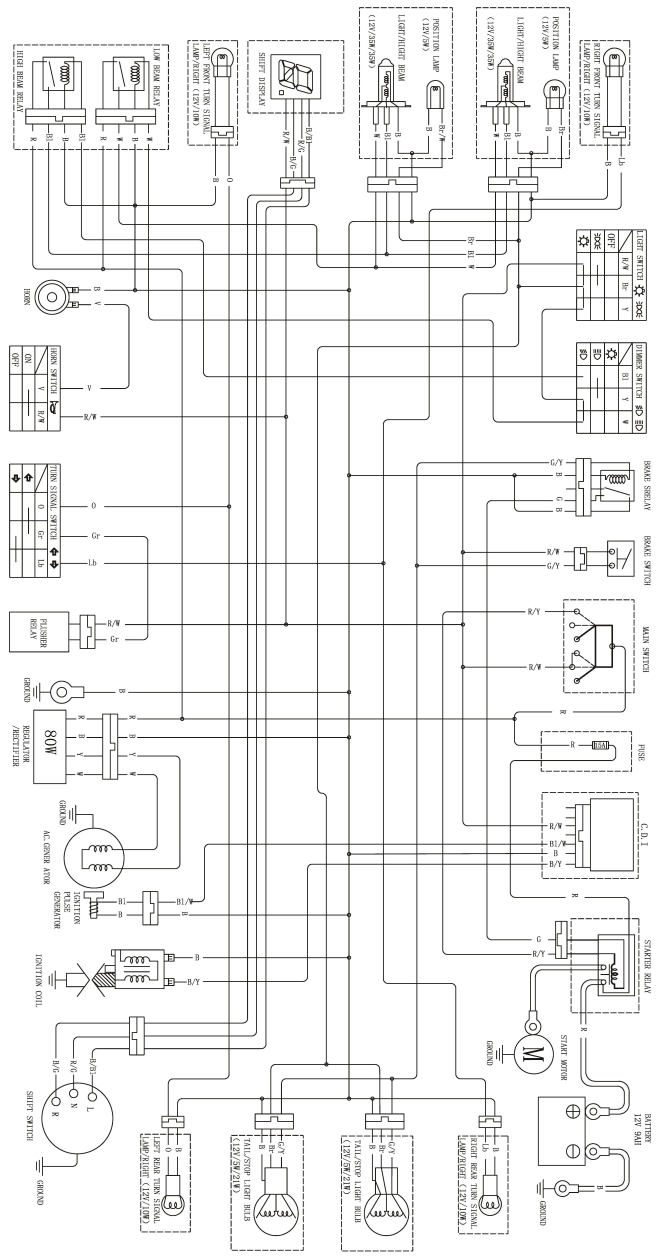

VEHICLE AND ENGINE NUMBER LOCATION

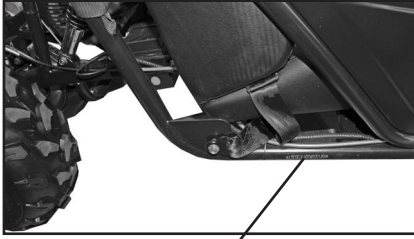

VIN #

The Vehicle identification number and the engine number are needed when calling for parts, service center help or when registering your Go Kart. Locate the numbers and list the numbers below for your reference.

The 17 digit Vehicle Identification Number (VIN) is stamped on the right side of the go-kart on the metal frame.

Vehicle Identification Number

--	--	--	--	--	--	--	--	--	--	--	--	--	--	--	--	--	--

ENGINE #



The engine number is located on the left, bottom rear portion of the Go Kart Engine.

Engine Number

--	--	--	--	--	--	--	--

--	--	--	--	--	--	--	--

NOTES