

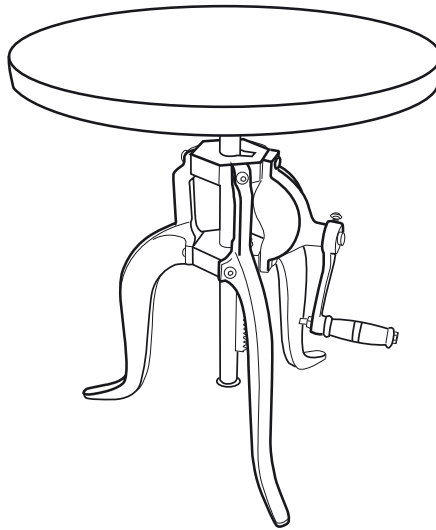

# CAROLINA FORGE







## Assembly Instructions Item # CF3931

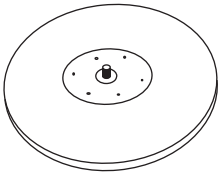

**NOTE:**  
When attaching leg in Step 1 if the holes do not line up, Loosen the top bolt of the other 2 legs, adjust middle hexagonal piece and then retighten top bolts.  
\*Do not completely remove bolt of other 2 legs\*

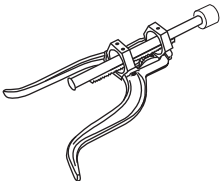

Thank you for purchasing a Carolina Forge Company product. This product has been designed for easy assembly and is constructed for durability. Please take the time to read and follow the assembly instructions carefully. If a part or hardware is missing or you have any difficulties in assembling this product, please contact us Toll Free 1-800-228-3876.

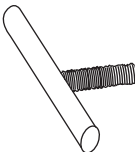
NO.	PART	DESCRIPTION	Q'TY	NO.	PARTS	DESCRIPTION	Q'TY
A		Top	1PC	B		Leg	1PC
C		Base	1PC	D		Handle	1PC
E		Allen Head Bolt 8mm 20mm	3PCS	F		Allen Head Wrench 5mm	1PC
G		Knob	1PCS				



# CAROLINA FORGE

Assembly Instructions  
Item # CF3931

## STEP 1

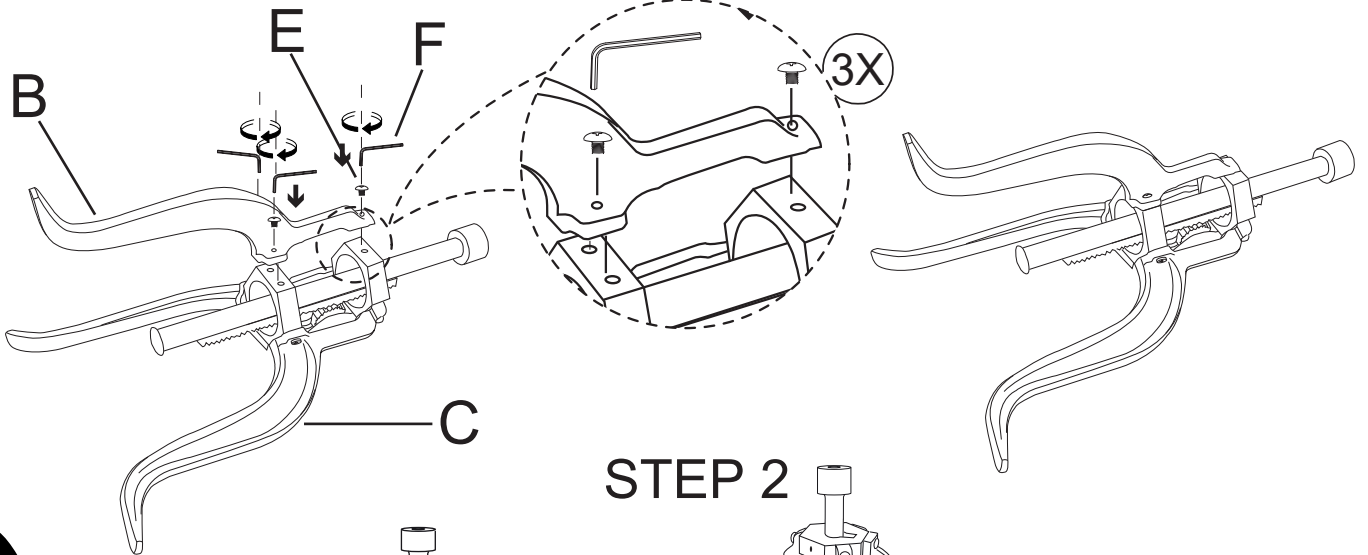

## STEP 2

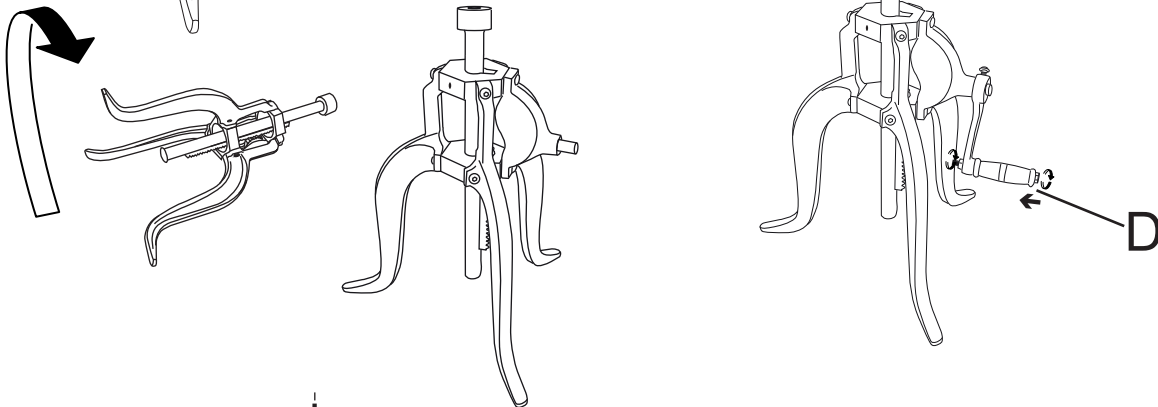

## STEP 3

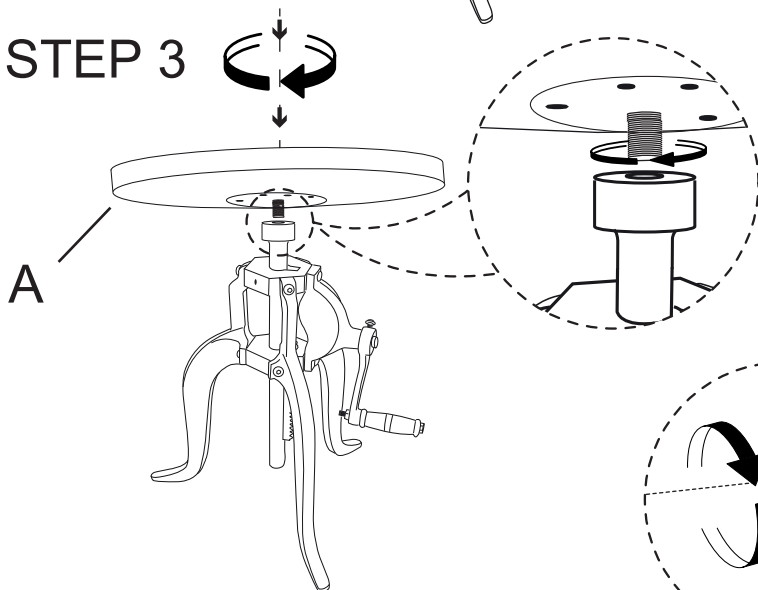

## STEP 4

