

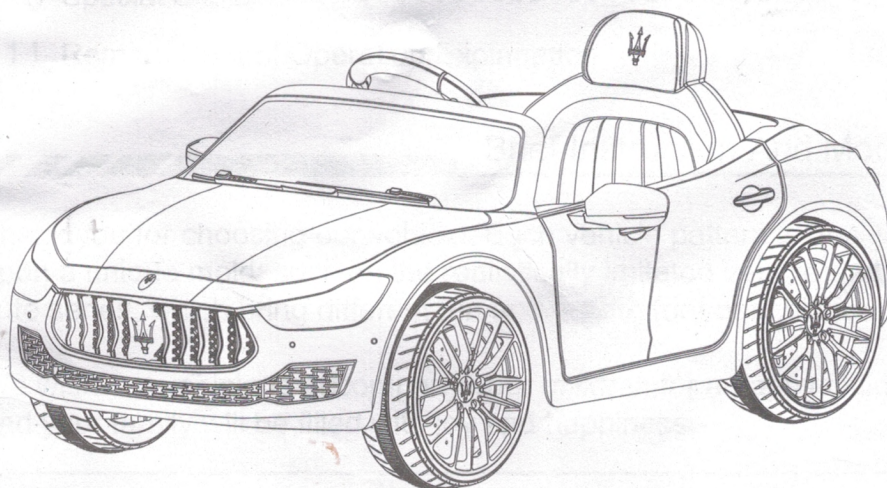

MASERATI

OFFICIAL LICENSED PRODUCT

GUIDE BOOK



The car must assembled and inspected by adults.
Products features may vary from the pictures in book, configuration based on your order!

CHOKING HAZARD--Small parts, it is not for children under 3 years!

- Please read the operating instructions carefully before using.

1 Brief Instruction and Model ----- 01

2 Safety Instruction -----02-03

3 Caring for Your Vehicle 04

4 Packing List ----- 05

5 Assembly Steps ----- 06-07

6 How to Operate Your Vehicle -----08-09

7 Charging Your Vehicle ----- 10

8 Disposal of Battery ----- 10

9 Problems and Solution Guide -----10-11

10 Special Explaintion ----- 12

11 Remote Control Operation Explanation 13

Brief Instruction And Model

Thank you for choosing our vehicle. Each vehicle pattern is designed upon a unique mold: such as the realistically imitated vehicle and cute series, which bring different fun and feeling for your children.

We wish our vehicle to accompany your children for a happy childhood and your family will be filled with joy and happiness. ewv

Suitable Age	37-95 Months	Load Capacity	≤35kg
Driving Motor	RS390	Turning Motor	RS280
Speed	3-4.5 KM/H	Size of Car	108*56*44 MM
Charger	Input:220V 50Hz Output :DC12V 700ma	Battery	12V/4.5AH*1
Power Way	Charging Type	Charging Time	8-12 Hours
Fuse	10 A	Average Battery Life	Approximately 300

Read carefully and follow all the instructions

⚠ WARNING ! CAUTION

Assembly/Used

⚠ Product requires adult assembly.

parts, sharp edges and sharp points in the vehicle's unassembled state.

⚠ Care should be taken in unpacking and assembly of the vehicle.

Children should not handle parts, or help in assembly of the vehicle.

⚠ Small assembling parts have choking danger, forbidden to children's play.

This product is forbidden to children under 3 years.

⚠ Always properly handled the protective material and poly bags before assembly. Forbidden to children's play and have suffocation danger!

⚠ Suitable for age 37~95 months; Maximum user weight is 35 Kgs.

Direct Adult Supervision Required Never leave child unattended by himself.

⚠ Always keep child in view when he is in vehicle. Teach safety rules to your child before allowing operation of this vehicle. These rules should also be reviewed with other playmates who want to drive this vehicle. Make sure children know and follow these rules for safe driving and riding:

- Always wear shoes.
- Always sit on the seat with safety belt.
- Always wear a helmet when riding. Only one rider at a time.

⚠ Keep children within safe riding areas, these areas must be:

- Warning. Not to be used in traffic. Away from steps/cars/driveways /roads and alleys.
- Away from sloped/inclined surfaces/swimming pools or other wet place.
- Away from other dangerous places.
- Only outdoors. Generally flat ground/playground and other hard surfaces.
- Play in daytime, avoiding in rainy or dark day, or maybe occur danger.

⚠ Warning. This toy has no brake. Before using, adult should check the main components whether the car whether in good condition:

Battery plug should be plugged in, power is switched; battery/charge/wire/plug/car body and other parts whether is damage; whether screw loose; whether have another damage problems.

To avoid using damaged car until it repaired.

! The toy should be used with caution since skill is required to avoid falls or collisions causing injury to the user or third parties.

! To avoid damaging the motors and gears, stop the vehicle before shifting from forward to backward switch.

! Please turn forward/stop/backward switch to "O" in the state of no-driving. Turn off power switch.(notice: this switch only control the parts of drive.)

Important Safety Instructions

- ! Do not let any child touch the wheels or near them when the car is moving.
- ! Do not tow anything behind the vehicle or overload it, do not exceed the maximum weight capacity of 35 kgs.

Battery/Charger/Alkaline Batteries

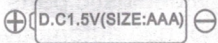
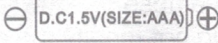
- ⚠ The battery/ charge/ alkaline batteries are not toy, forbidden for children playing.
- ⚠ Non-rechargeable batteries are not to be recharged.
- ⚠ Do not mix old and new batteries or batteries of different types: alkaline, standard (carbon-zinc) or rechargeable (nickel-cadmium).
- ⚠ Battery charging must be done by adults only.
- ⚠ Remove rechargeable batteries from the vehicle before charging.
- ⚠ Insert batteries are correct polarity inside the battery compartment. (Like the picture)
- ⚠ Remove exhausted batteries from the product. 
- ⚠ Remove batteries during long periods of non-use. 
- ⚠ Never short-circuit the battery terminals.
- ⚠ Use only with manufacturers prescribed rechargeable battery and charger.
- ⚠ Do not use the battery or charger for any other product. Could cause overheating, fire or explosion.
- ⚠ Do not open the battery and the charger
- ⚠ Do not charge battery upside down.
- ⚠ Always maintain battery dry. Do not let the vehicle contact fresh water or salt water.







Charge

- ⚠ Charge 4-6 hours before the first time using, but not charge over 10 hours.
- ⚠ Only adult can handle or charge the battery. Never allow children to do that. Turn off power switch before charge the battery.
- ⚠ Connecting correct polarity when charging.
- ⚠ Examine the battery, charger and their connectors for excessive wear or damage each time you charge the battery. If damage or excessive wear is detected, do not use the charge or the battery until you have replaced the worn or damaged parts.
- ! When the vehicle's normal speed apparent slow down or after each use, recharge the battery for 8-12 hours, never charge the battery longer than 18 hours.
- ! Charge the battery in a dry area ONLY.
- ! It is normal that charger and battery are tepid while charging.
- ! Charge the battery at least three months one time, even if the vehicle has not been used.
- ! In room temperature below 5 degrees centigrade, charging the actual to lengthen 3-5 hours. Below -5 Celsius please do not use this product.

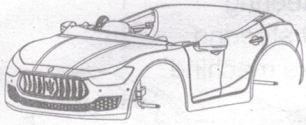
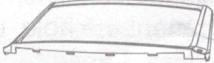
1. Vehicle body is modeled by polypropylene. Solarize or in -15°C use are strictly prohibited. Vehicle should be far away from hot objects, like an oven and heated plastic parts may melt beside.
2. Avoid operating the vehicle in wet or snowy conditions, and do not spray the car with a hose. Do not wash the vehicle with soap and water. Water or moisture in the motors or electrical switches can cause them to corrode and can cause switch or motor failure.
3. Avoid operating the vehicle on sand, loose dirt or gravel. Sand, loose dirt or gravel in the motors or electrical switches can case them to jam, and could cause switch or motor failure.
4. The vehicle can be wiped down with a soft, dry cloth for a shiny finish, you can wipe plastic parts with a non-wax furniture polish applied to a soft-cloth. Do not use automotive wax. Do not use soap or water or spray the vehicle with a hose.
5. Do not modify the electric system. When the fault appears and they must be maintained by professional. Alterations could cause a fire resulting in serious injury and can also ruin the electrical system.
6. Use for about half month, check the wheels turning agilely or not, motor work is normal or not. Using infuse lube to lubricate moving parts.

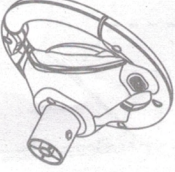
Packing List

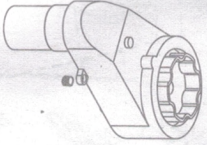
Please identify all parts before assembly and save all packaging materials until assembly is complete.

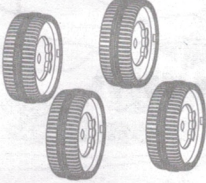
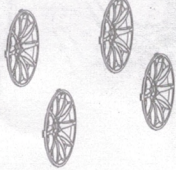
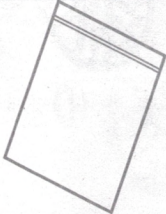
		
1	2	3
Main Body	Windshield	Charger
		
4	5	6
Steering Wheel	Seat	Rearview Mirror
		
7	8	9
Driving Motor	Guide Book	Remote Control
		
10	11	12
Wheel	Wheel Cap	Accessory Package

Step 2: Steering Wheel Assembly

Connect the music connector and power assisted steering connector pair the connector on the car. Then insert steering wheel into direction lever, alignment the hole, use the machine screw to tighten.

Step 3: Front Window Assembly

Insert the front window to the instrument of the car, press to the right place until hearing the "crack".

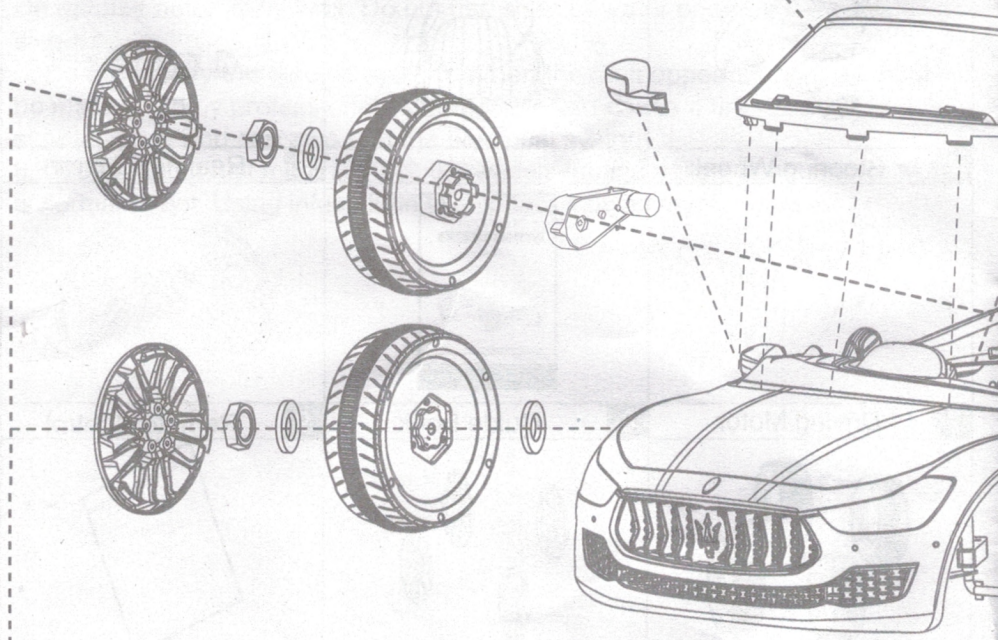

Step 1: Front, Back Wheel Assembly

According the picture put gasket, front wheel, axle sleeve, gasket, screw on the nut, wheel cup.
According the picture put back wheel, axle sleeve, gasket, screw on the nut, wheel cup.

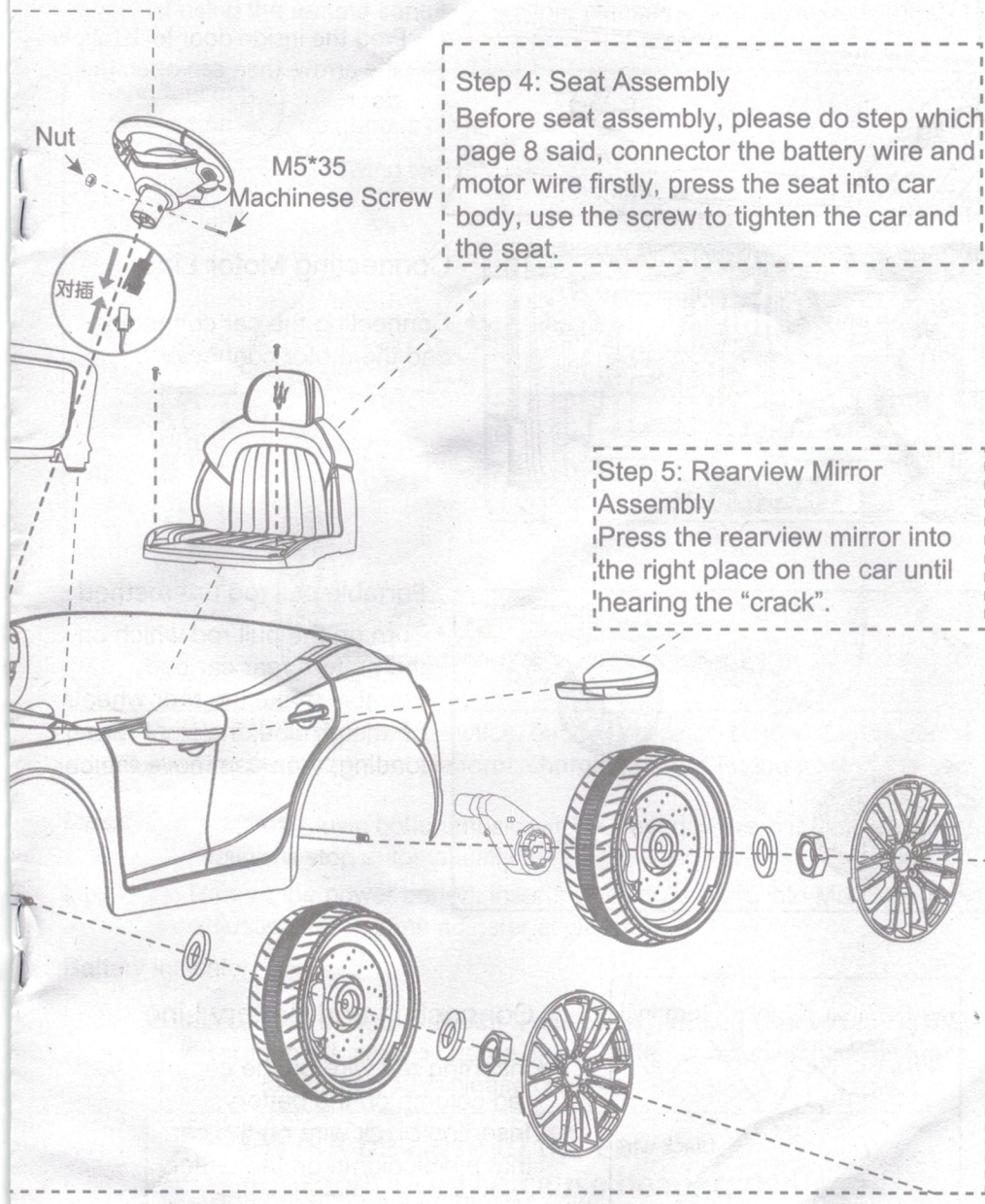

Step 4: Seat Assembly
Before seat assembly, please do step which page 8 said, connector the battery wire and motor wire firstly, press the seat into car body, use the screw to tighten the car and the seat.

Step 5: Rearview Mirror Assembly
Press the rearview mirror into the right place on the car until hearing the "crack".

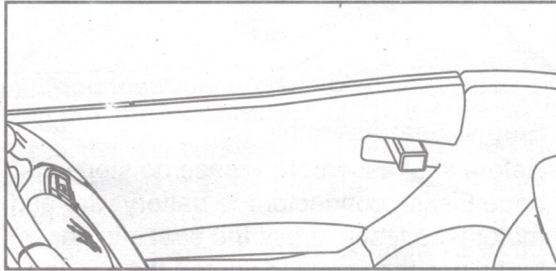

Open door method

- Prod the inside door lock follow the arrow, then can open the door.

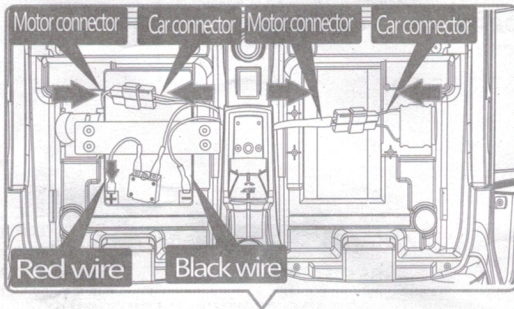

Connecting Motor Line

- Connecting the car connector and the motor connector

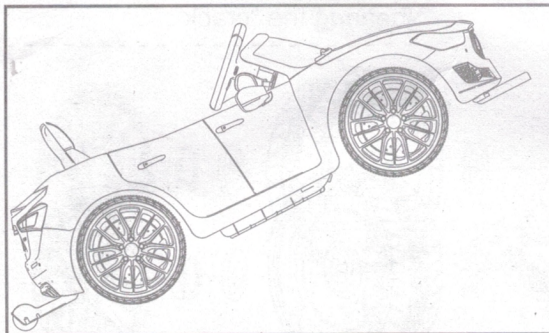

Portable pull rod use method

- Turn on the pull rod which on the bottom rear car body , portable make the rear wheels off the ground, the front wheels loading, then can move the car.

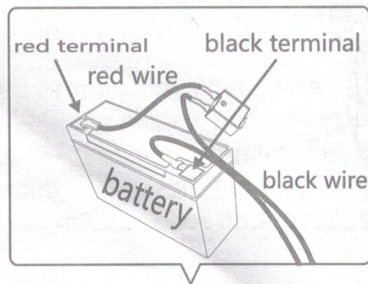

Connecting and Battery Line

- Inserting red wire on the car into red column on the battery. Inserting black wire on the car into blackcolumn on the battery. (Avoiding inserting into the uncorrect polarity)

Notice: When you switch forward/backward, please make sure the vehicle has completely stopped, otherwise it will damage the gear box and the motor. If using the remote control operation, please refer to guide book page 14.

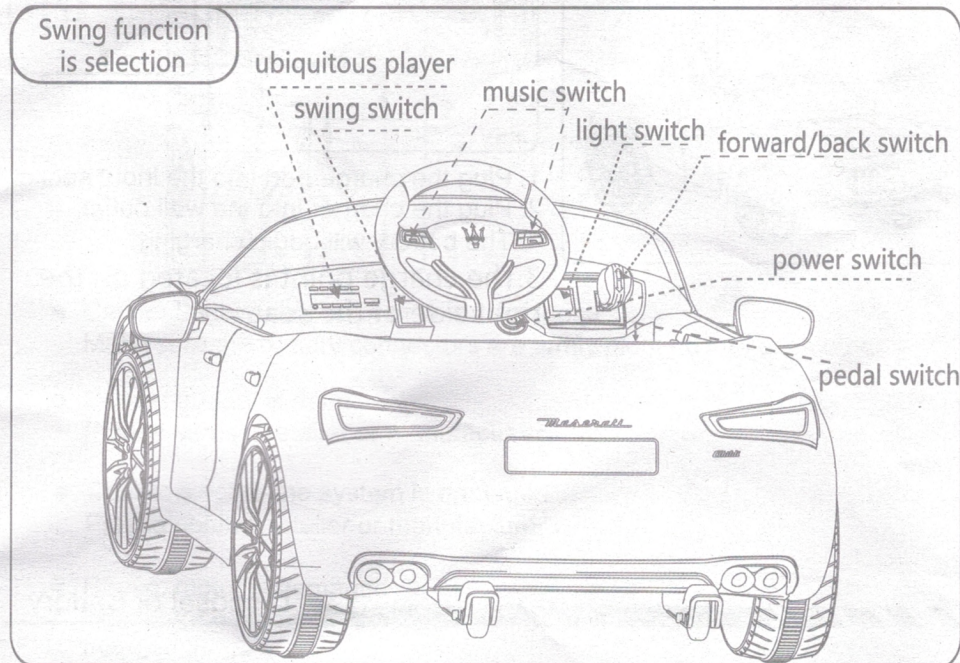

power switch, forward/backward switch, battery indicator, MP3 slot and volume adjuster are on the instrument platform, charging hole is on the front of the seat.

Music Press the music button, music will be played. If there is no more press, music will stop automatically

Mp3 Turn on the power button, inserting Mp3/Mp4 wire into Mp3 slot, then adjusting the volume adjuster as you like.

Battery indicator

this car has battery indicator. If one battery, usually max voltage is 6.5V, lower than 6V, please charge. If two batteries, usually max voltage is 13.1V, lower than 12V, please charge).



Do not be close to the ear, improper use can cause hearing damage !

Charging Your Vehicle

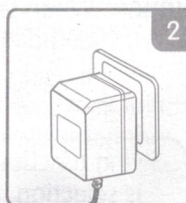
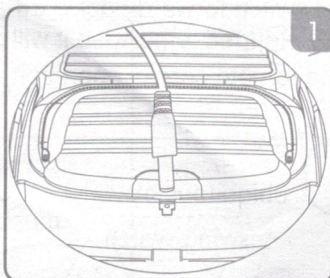
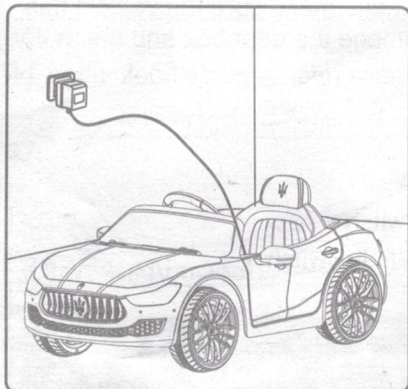

1. Plug the charge port into the input socket;
2. Plug the charger into the wall outlet.
The battery will begin charging.
3. The charge point is located on the right side of the seat.

Disposal of Battery



- Do not throw into a fire. The battery may explode or leak.
- Your sealed lead-acid battery must be recycled or disposed of in an environmentally sound manner, or will pollute the environment.
- Return an exhausted battery to your local approved lead-acid battery recycling center.

Problems and Solution Guide

Problem The vehicle does not run

- **Cause:** The battery may be low on power.
After each use and once a month minimum, charge the battery for 8-12 hours.
Do not charge over 18 hours.

- Cause: Thermal fuse has tripped. The vehicle is equipped with a self-resetting fuse. When the vehicle is overloaded or operated incorrectly, the self-resetting fuse will be cut off for 2 minutes before becoming operational again. The self-resetting fuse is under the seat (refer to the picture)

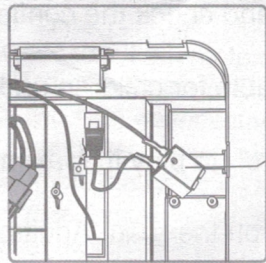

self-resetting fuse

10 A

- Cause: battery connector or wires are loose
Make sure the battery connectors are firmly plugged into each other.
- Cause: battery is dead
Please contact retailer or manufacturer.
- Cause: electric line system is damaged
Please contact retailer or manufacturer.

- Cause: motor is damaged
The motor needs professional repair. Please contact retailer or manufacturer.

Problem: The battery can not be charged

- Cause: battery connector is loose.
Make sure the battery connector is firmly plugged into each other.
- Cause: charger is not plugged in.
Make sure the charger is plugged into the wall outlet and the wall outlet power is on.
- Cause: charger is not working?
Is the charger warm while charging? If not, the charger may be broken and please contact retailer or manufacturer.

Problem: The vehicle does not run very long

- Cause: battery may be undercharged
You may not be charging the battery long enough. After each use or per month charge the battery for 8-12 hours. Do not charge over 18 hours.

**WARNINGS**

1. Please check the guide book carefully before using and keep it properly for further checking.
2. The vehicle must have been installed and check the confirmation by adults before use.
3. Suitable age is 37-95 months, not suitable for children under 3 years old or above 8 years old.
4. Forbidden overage and overload children to play it. Maximum capacity is 35KG.
5. It is not a vehicle. Please do not play it on the road. Adults should supervise.
6. Forbidden to play it in the public street, road, slope, pool or stair and other dangerous areas.
7. Do not use this product in high-voltage line, transformer station, gas station, hospital.
8. Charging should be done by adults. Away from inflammable or explosive objects. Do not let children play charger, it is not a toy.
9. Do not wash the vehicle with water, use a soft damp cloth to clean.
10. Must use this vehicle with shoes, with safe-belt.
11. In order to prevent a child from suffocation, keep plastic bags away from children.
12. Only adult can operate the remote control, and must keep distance within 10m for remote control and car. In the same place, must not have two or two above cars using remote control.

⚠️ Only adults can use remote control, children are not allowed.
 Battery assembly: remove the screw from the remote control's battery cover, open the cover, put two AAA 1.5V batteries (not included) into it according to the direction of the +/-, then put the battery cover.
 (Long time no use, please remove the battery. If replace the batteries, step is the same.)

How to use the remote control:

1. Remove the screw from the remote control's battery cover, open the cover, put two AAA batteries(not included) into it according to the direction of +/-, then put the battery cover(if long time do not use, please remove the batteries, just assemble the batteries in an opposite way for next use).
2. Press frequency adjustment, frequency adjustment light will light, then open power switch again.
3. When frequency adjustment light stops flickering, it quenches or lights all the time, it means frequency adjustment is finished.
4. When you need move forward or backward, please press forward/backward button.
5. When you need turn left or right, please press left/right button.
6. When you need to change speed, please press speed adjuster.
7. When you want to stop the car, please press stop button.

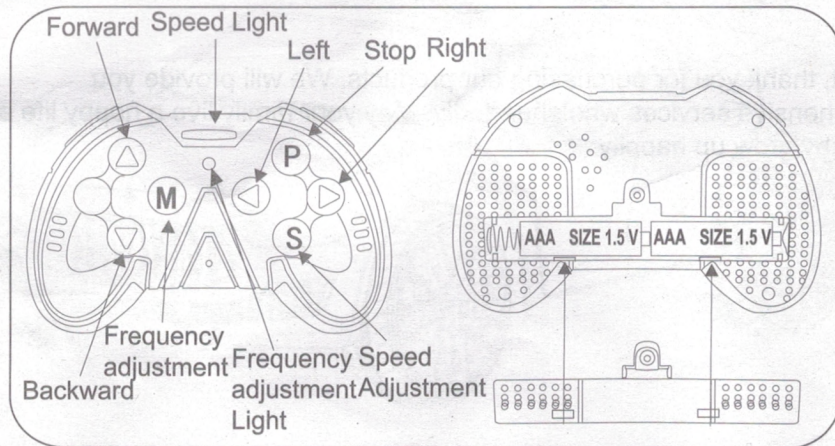

All buttons on the remote control play together will be more fun.



If the battery is short of energy, the remote control only can control cannot control turning. Please replace new battery.



Please do not play the car at these areas: highline, transfor substation, gas station, hospital



Remote control only can operate by adults. Remote control distance is 10 meters. One area can only play one car, two cars may interference each other.

Operative norm:

- EN 71-1 EN 71-2 EN 71-3 EN 62115
- ASTM F963

The illustration adopted in the explanation is used for explaining product's operating measures and configuration. When there is little difference between assembly diagram and practicality, according to the real object please.

Improvement in vehicle will be added to the manual of new edition, there is no extra information. The company reserves the right to change the manual of its models at any time.

At least, thank you for purchasing our products. We will provide you comprehensive services wholeheartedly. May your family live a happy life and your baby grow up happily.

“Trademarks, design patents and copyrights are used with the approval of the owner Maserati”

Licensee : Shanghai Happy Children Factory