

CARE INSTRUCTIONS

Thank you for choosing northbeamtm TRADITIONAL ROCKING CHAIR. With a little care and maintainance, the northbeamtm TRADITIONAL ROCKING CHAIR will provide you with comfort and enjoyment for many years to come!

- To clean panels, use clean water on a damp cloth.
- When assembling northbeamtm TRADITIONAL ROCKING CHAIR, please handle all the panels and/or hardware with care to avoid any possibilities of damages and/or injuries.
- Cover during harsh weather to keep it from weathering.
- It is highly recommended that you treat the northbeamtm TRADITIONAL ROCKING CHAIR with a weatherproof coating of (stain or paint) once a year, to increase life expectancy and maintain the look.



NOTE: Please read all instructions carefully before starting assembly. Also, we recommend that the unit is fully assembled on a level surface. Two people are recommended to assemble this product. DO NOT over torque screws and bolts.

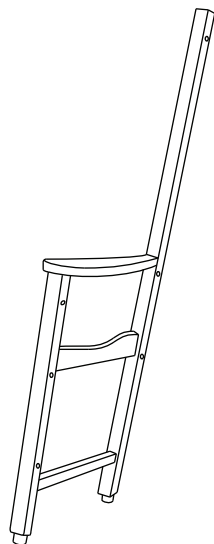

1 LEFT SIDE

X 1PC

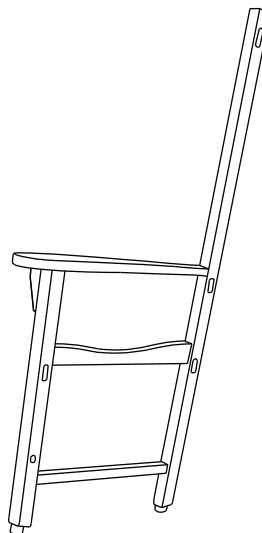

2 RIGHT SIDE

X 1PC

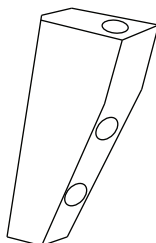

3 LEFT SIDE ARM SUPPORT

X 1PC

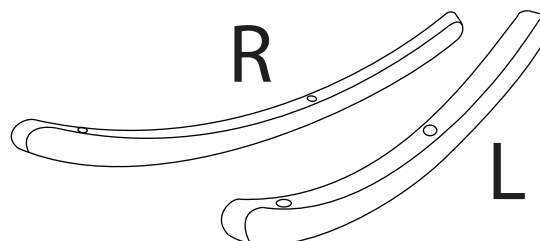

4 ROCKERS

X 2PCS

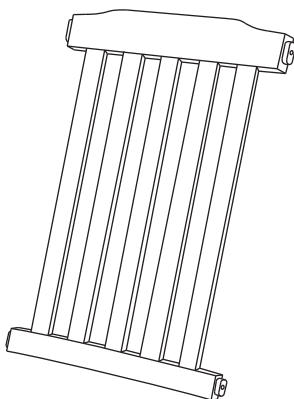

5 BACK

X 1PC

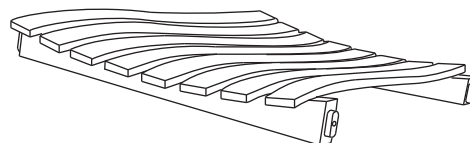

6 SEAT

X 1PC

NOTE: Please read all instructions carefully before starting assembly.
 Also, we recommend that the unit is fully assembled on a level surface.
 Two people are recommended to assemble this product.
 DO NOT over torque screws and bolts.

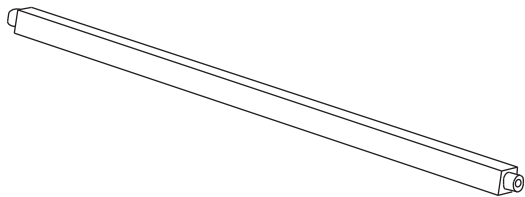
**7**

FRONT RAIL

X 1PC

A  7x70x15 LARGE SCREW 14PCS

B  4x30 SMALL SCREW 2PCS

 HEX WRENCH 1PC

NOTE: Please read all instructions carefully before starting assembly.
Also, we recommend that the unit is fully assembled on a level surface.
Two people are recommended to assemble this product.
DO NOT over torque screws and bolts.

1

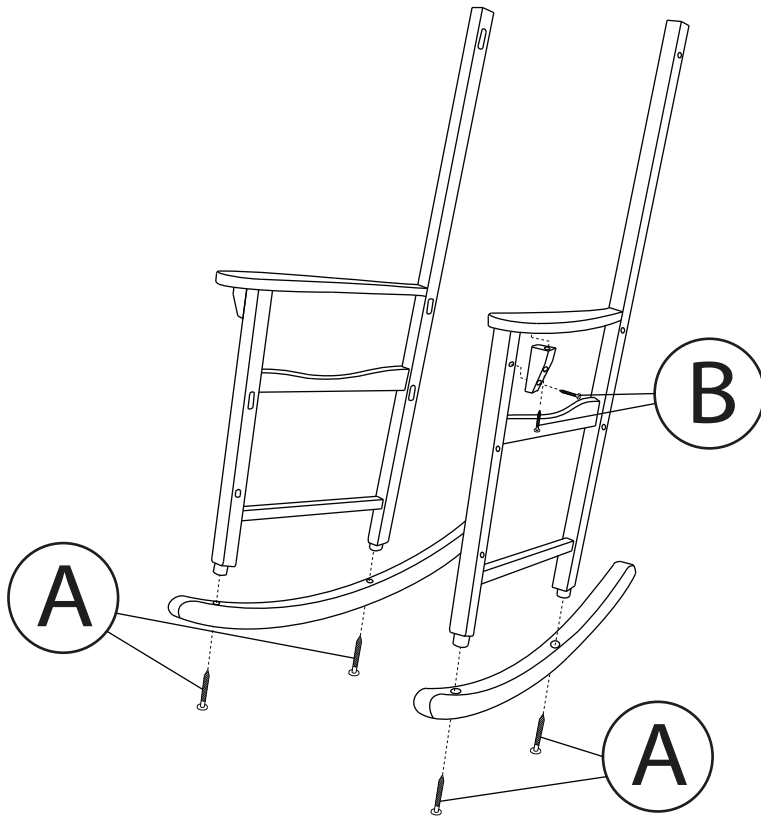

2

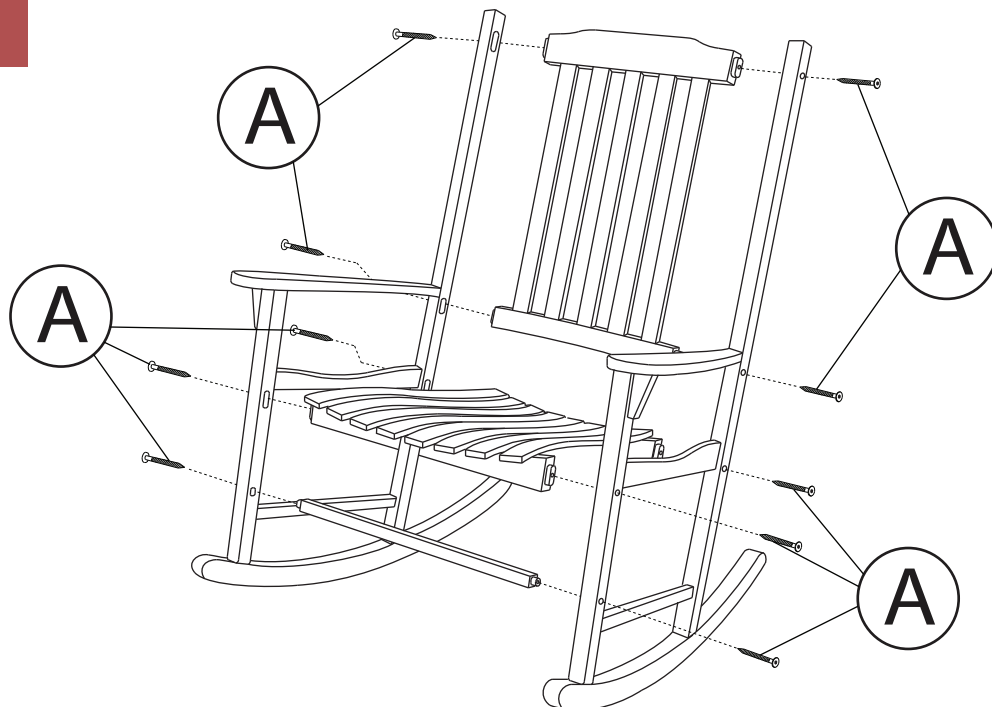

NOTE: Please read all instructions carefully before starting assembly.
 Also, we recommend that the unit is fully assembled on a level surface.
 Two people are recommended to assemble this product.
 DO NOT over torque screws and bolts.

Please check contents before assembly. If any items are missing or damaged, do not take the unit back to the store. Call (775) 629-5029 or email: service@merryproducts.com for customer service and we will save you time by correcting any problems directly for you.

NOTE: Please read all instructions carefully before starting assembly. Also, we recommend that the unit is fully assembled on a level surface. Two people are recommended to assemble this product. DO NOT over torque screws and bolts.