



1422961

DUAL SIDED WALK IN GREENHOUSE

INSTRUCTION MANUAL



Distributed by:
TRACTOR SUPPLY COMPANY
5401 VIRGINIA WAY,
BRENTWOOD, TN 37027
For customer support,
call: 1-888-376-9601
www.TractorSupply.com
Made in China

Distributed by:
TRACTOR SUPPLY COMPANY
5401 VIRGINIA WAY,
BRENTWOOD, TN 37027
For customer support,
call: 1-888-376-9601
www.TractorSupply.com
Made in China

Approximate
assembly time: **20 Minutes**









People
for assembly:

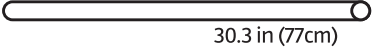
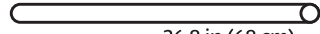
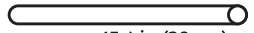
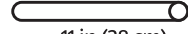
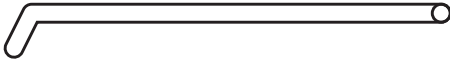

Assembled dimensions:
4.7ft. W x 2.4ft. D x 6.4ft. H
(1.43m x 0.73m x 1.95m)

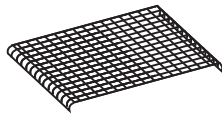

PARTS LIST

| | |
|--|--|
| <p>① 3 Piece</p>  <p>30.3 in (77cm)</p> | <p>② 17 Piece</p>  <p>26.8 in (68 cm)</p> |
| <p>③ 24 Piece</p>  <p>15.4 in (39 cm)</p> | <p>④ 16 Piece</p>  <p>11 in (28 cm)</p> |
| <p>⑤ 4 Piece</p>  | <p>D Part D 6 Piece</p>  <p>D</p> |
| <p>E Part E 26 Piece</p>  <p>E</p> | <p>J Part J 2 Piece</p>  <p>J</p> |
| <p>Shelves - 8 Piece</p>  | <p>Cover - 1 Piece</p>  |
| <p>Ground Pegs - 8 Piece</p>  | <p>Wind Ropes & Ground Pegs - 4 Piece</p>  |

TIPS BEFORE YOU START !

1. Ensure that all parts are present prior to assembly.
2. Check all packing material carefully before discarding, as some parts may be encased in the packing material.
3. For ease and speed of assembly, it is recommended that prior to each step all required parts are identified.
4. Ensure that you have sufficient space and people (as indicated on cover page) to assemble product safely.

Step 1. Build up bottom base and the second two shelves.

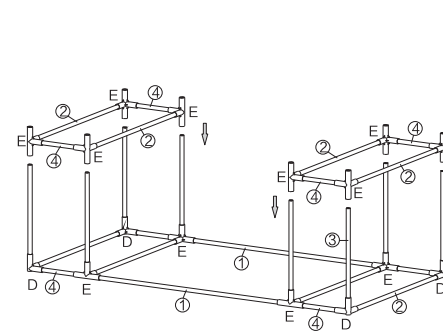

Step 2. Build up middle shelves and top shelves.

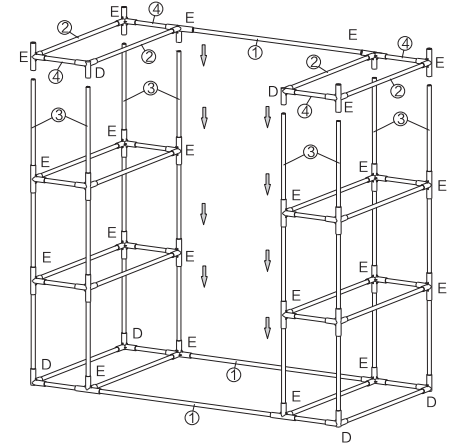

Step 3. Build up the top frame

1. Connect ②, ⑤ to Part J.

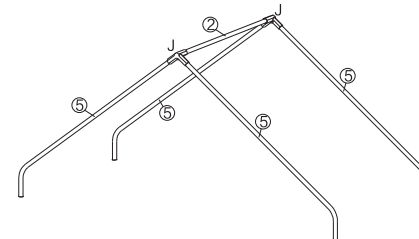

Step 4. Insert the top frame into the main frame

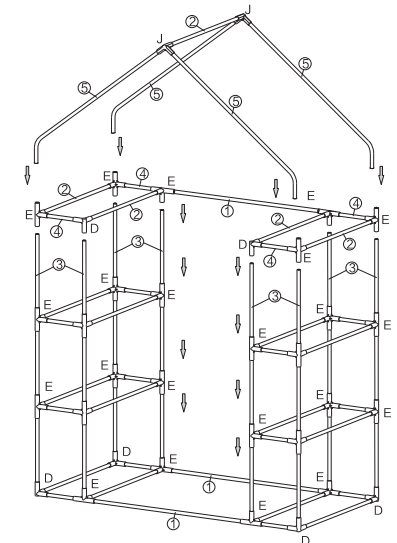

Step 5. Put the wire mesh on each shelf

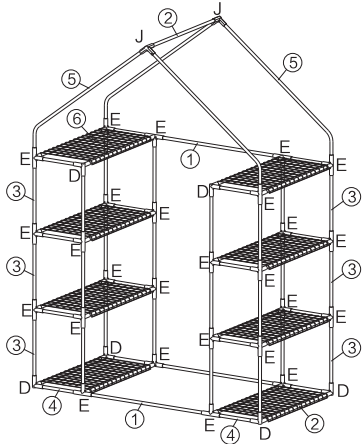

Step 6.

1. Put the cover on the whole frame.
2. Insert the steel ground pegs into the 8 holes at the bottom of cover.
3. Put the wind ropes through the 4 loops on the corner of the cover.
4. Tie the wind ropes to the 4 plastic ground pegs, and then insert them into ground .



ASSEMBLY INSTRUCTIONS

Please read before assembly and keep for future reference.

INSTRUCTIONS

- Start with the cover unzipped .
- Assemble as shown in figure .
- Secure to frame with ties attached to inside of cover .
- Please ensure that it is assembled on flat ground.

IMPORTANT

- Please check the pack contents before assembly. And remember the codes/letters of different tubes .
- A full list of parts is given on previous page .
- The greenhouse should be located in a sheltered spot away from prevailing winds .
- To avoid damage to the cover please unfold it carefully and allow it to rest until completely flexible .
- If cover fits tight , please make sure tubes are fully into connectors. If necessary , support connectors by wall or ground , then apply some gentle pressure on tubes .

SAFETY



Risk of injury!

Improper use or assembly of the greenhouse may result in injury.

- Make sure that the greenhouse is only assembled by competent persons.
- Do not assemble the greenhouse in strong wind or under bad weather.
- Do not leave children unattended nor allow them to play with the greenhouse. The greenhouse is not a climbing frame or toy.
- Make sure children do not play with the plastic wrapper. They may get caught in it when playing and suffocate.
- Only set up the greenhouse on a flat, level and stable surface. Otherwise, there is a risk of it falling over and injury.
- Be careful of where you place your fingers and hands when assembling the greenhouse. You may accidentally pinch your fingers and/or hands.
- Only use the greenhouse when it has been appropriately assembled.
- Evenly distribute the load on the greenhouse so that it cannot overturn.
- Always remove all items from the greenhouse before moving it.
- Do not stand, lean or jump on the greenhouse. Do not use the greenhouse as a climbing aid or steps.
- Do not rely on the greenhouse as your shelter from extreme weather.
- Never store the greenhouse in such a way that there is a risk of it falling over, or falling from an elevated position.

NOTICE!

RISK OF DAMAGE!

Improper handling of the greenhouse may result in damage to the greenhouse.

- Do not position the greenhouse in an area exposed to excessive wind.
- Make sure the greenhouse is stable before use.
- In winter, regularly remove the accumulated snow on the roofs of the greenhouse to avoid dangerous snow-loading.
- Do not exceed the load-bearing capacity per shelf of 19.8 lb (9.0 kg) .
- Never place the greenhouse on or near heat sources such as ovens or heaters.
- Do not light a fire inside the greenhouse.
- Do not use the greenhouse if it is cracked, deformed or broken.

CLEANING

Improper handling of the greenhouse may result in damage to the greenhouse.

- Do not use any aggressive cleaners, brushes with metal or nylon bristles, or sharp or metallic cleaning utensils such as knives, hard scrapers and the like. They could damage the surfaces.
1. Remove all items from the greenhouse.
 2. Wipe the greenhouse clean with a damp cloth. Use a mild detergent if necessary for stubborn stain.
 3. Let all parts dry completely.

STORAGE

All parts must be completely dry before being stored.

- The cover can be removed and the main frame should be disassembled for storage.
- Always store the greenhouse in a dry area and keep it out of direct sunlight.
- Store the greenhouse so that it is not accessible to children.

TECHNICAL DATA

| | |
|----------------------------------|---|
| SKU # : | 1422961 |
| Weight : | Approx. 15.4 lb (7.0 kg) |
| Dimension (W × D × H): | Approx. 4.7ft. W x 2.4ft. D x 6.4ft. H (1.43m x 0.73m x 1.95m) |
| Load-bearing capacity per shelf: | 19.8 lb (9.0 kg) |