







CAROLINA FORGE

Assembly Instructions
Item # CF3011
SCOUP SEAT COUNTER STOOL

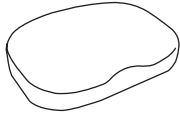
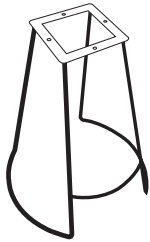

Thank you for purchasing a Carolina Forge Company product. This product has been designed for easy assembly and is constructed for durability. Please take the time to read and follow the assembly instructions carefully. If a part or hardware is missing or you have any difficulties in assembling this product, please contact us Toll Free 1-800-228-3876.

NO.	PARTS	DESCRIPTION	Q'TY	NO.	PARTS	DESCRIPTION	Q'TY
A		Seat	1PC	B		Base	1PC
C		Allen Head Bolt 1/4" 6/8"	4PCS				
D		Flat Washer Ø12*T1.0	4PCS	E		Allen Head Wrench 4MM	1PCS



CAROLINA FORGE

Assembly Instructions
Item # CF3011
SCOUP SEAT COUNTER STOOL

STEP1

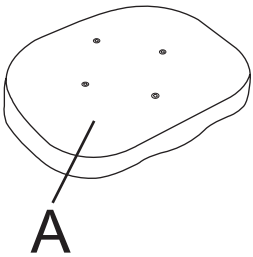

STEP2

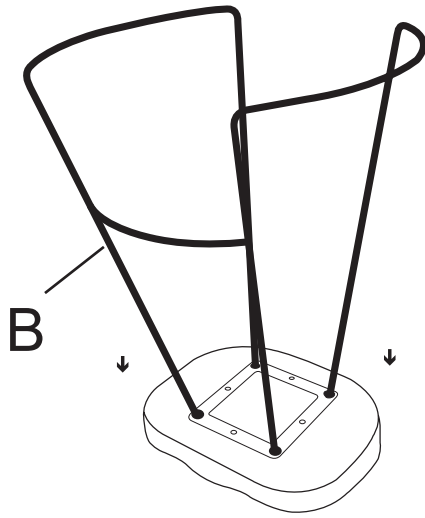

STEP3

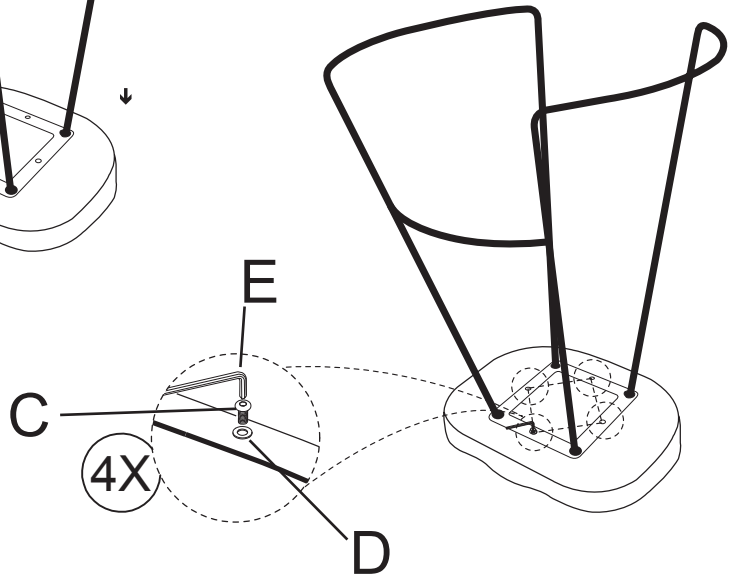

STEP4

