

[QUICK DAM]

THE NEXT GENERATION IN FLOOD PROTECTION™



M A N U A L

FLOODGATE



Table of Contents

- How They Work.....2
- What They're Made Of.....2
- Box Components.....3
- Flood Gate Sizes.....3
- Doorway Anatomy.....3
- Placing the Flood Gate.....4
- Installing Your Flood Gate.....5
- Side Rails.....6
- Instructions for Stanchion & Side Rails.....7
- Side Rails: Preparing the Opening.....8
- Stanchions: Laying Out the Hole Location.....10
- Boring the Holes for the Stanchion Base.....10
- Assembling the Angle Brackets to the Base.....11
- Preparing the Ground Surface and Base Recess.....11
- Inserting Base Assemblies.....12
- General Maintenance and Installation.....13
- After-Use.....14
- Terms & Conditions/Warranty.....14

TESTED & APPROVED

The Flood Gate is Kitemark certified, ensuring the highest levels of quality and safety.



HOW THEY WORK

- Flood Gates quickly seal off doorways from flood water
- Minimize water intrusion, of depths up to 23 inches, through doors or other openings.
- Flood Gates are not designed to withstand impacts from debris and/or waves.
- Effectiveness of Flood Gates is dependent upon pressure between sides and bottom of opening. The structure in which it is installed must be in good shape and able to withstand this pressure. The structure surface must have a smooth surface capable of maintaining a seal.

(A) FLOOD GATE - ADJUSTED FROM REAR OF PRODUCT (Shown without neoprene cover)

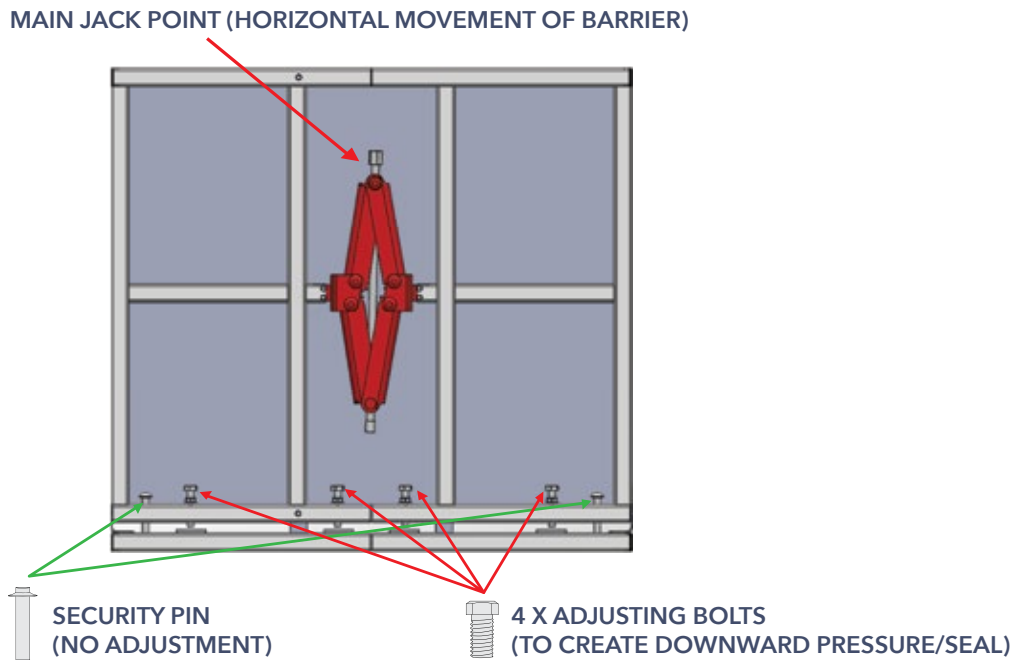

WHAT THEY ARE MADE OF:

- 1" Steel Tube Frame- provides the support structure
 - Steel tube is ASTM A3 with 0.2% carbon
 - Welding is AWS - D10.12
 - Yield Strength of the steel tube $\geq 235\text{Mpa}$
- 1/8" Front Steel Flat Sheets- block & take the weight of the water

Please note: Flat sheet is only connected on one side of the gate to allow for expansion
- 2 ton Scissor Jack - expands & creates a secure fit within door frame
- Neoprene Sleeve- surrounds entire system & provides a watertight seal around its perimeter

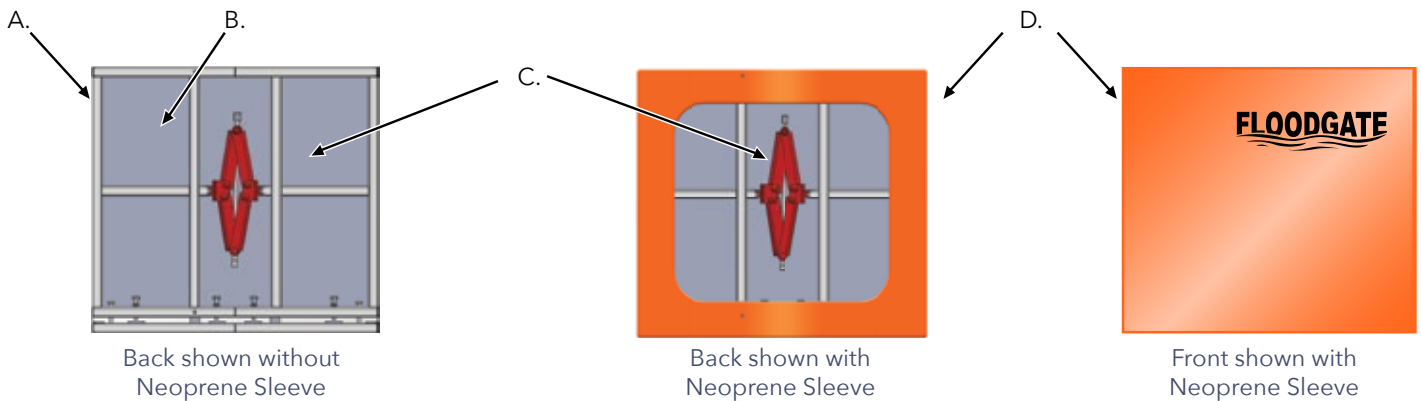

BOX COMPONENTS

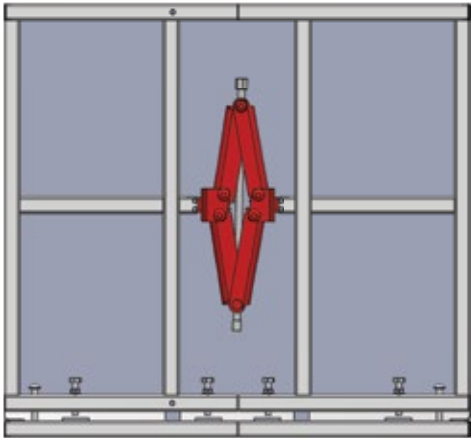

Flood Gate



Neoprene Sleeve

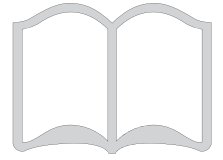

Instructions & Operations Manual

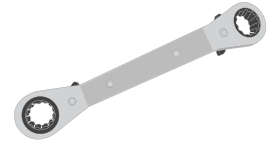

17mm Ratchet Wrench

FLOOD GATE SIZES

Determine the appropriate size or mixture of sizes of Flood Gates to fit your openings.

Flood Gate Size 25in- 30in
Max. Expansion: 34in
Height: 26.5in

Flood Gate Size 40in - 45in
Max. Expansion: 49in
Height: 26.5in

Flood Gate Size 30in- 35in
Max. Expansion: 39in
Height: 26.5in

Flood Gate Size 45in - 50in
Max. Expansion: 54in
Height: 26.5in

Flood Gate Size 35in - 40in
Max. Expansion: 44in
Height: 26.5in

Note:

For openings wider than 50in, stanchions must be used. See Flood Gate Stanchion Installation & Maintenance section of this manual on page 10.

For optimum layout, the Flood Gate can expand approximately 9in, but staying closer to 5in is preferred. Follow the guide to right to calculate how many units & what size you may need.

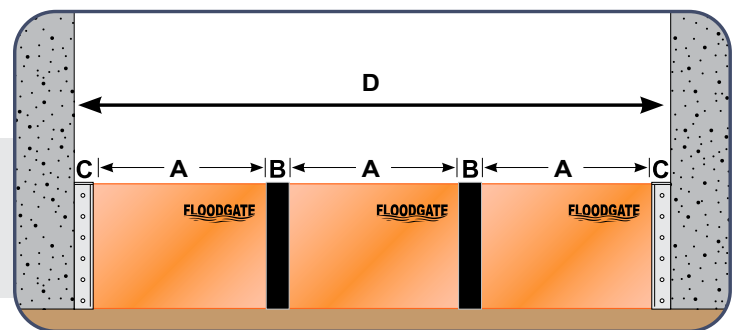

A=Gate Size

B width = 0.25in
Stanchion

C width = 0.125in
Side Rails

D width = Opening Size

DOORWAY ANATOMY

1. Width of opening (wall to wall within the reveal)
2. **Reveal** (measured from the outer side of the **door frame**, or furthest obstruction outwards, to the corner of the face wall of the building)
3. Construction of Reveal: Make sure that it is a smooth surface which will create the most effective seal. If it is not smooth, use optional Side Rails.
4. Which way does the door/window open (inwards, outwards, sash, sliding, up and over, roller shutter).

Example:

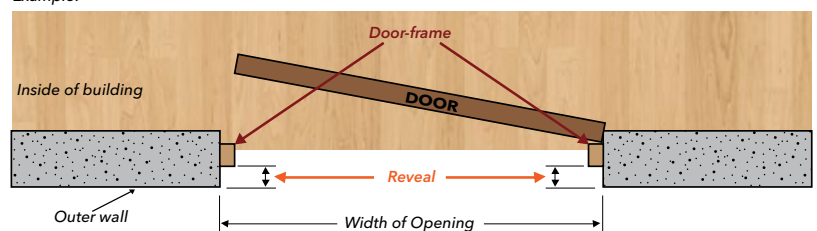

PLACING THE FLOOD GATE

Ideally, the Flood Gate should be placed on the outside of the property, in the reveal. All buildings differ in the amount of reveal available and their surface type; it is recommended that you check your wall and floor surfaces to ensure that water cannot seep under or around the barrier, nor into the side walls or framework. Add silicone caulk (not included) between Flood Gate and reveal as needed.

#1 Inward Opening Door (Preferred Placement):

Place Flood Gate outside for continued access during flooding.

Example: Preferred Placement. (Outside)

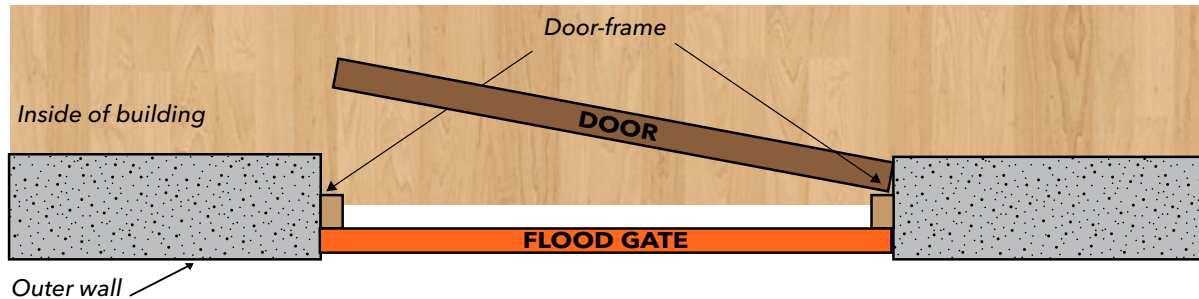

#2 Outward Opening Door:

Place Flood Gate inside for continued access during flooding.

Requires sufficient reveal for the Flood Gate to grip the wall. Ideally, 2" (50 mm) of reveal is recommended, although 1¼" (32 mm) - 1" (25 mm) may be sufficient as long as the Flood Gate can grip tight. This should be measured from the furthest outward point on the door (usually the frame but look for threshold at the bottom of the door that often protrudes into the reveal space).

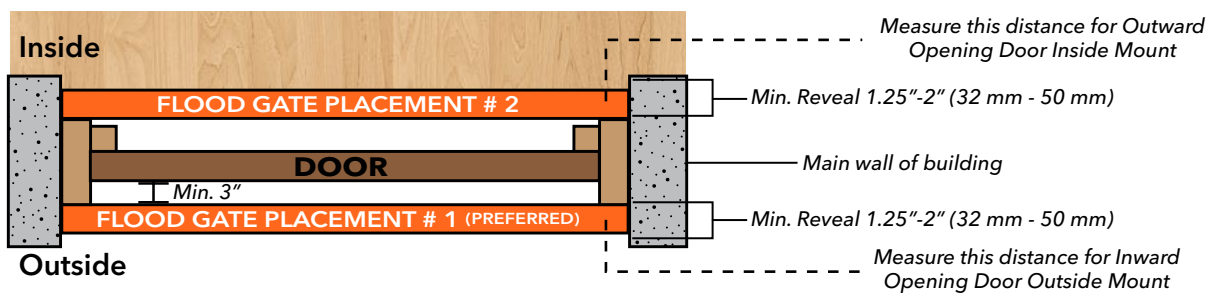

Note: If door opens out, you will need a minimum distance of 3in between the Flood Gate and the door to access the jack and bolts with a ratchet socket extension that is a minimum of 27in long (shown at right).



#3 Other Openings:

Flood Gates can be used in other entryway situations such as sliding doors, elevator doors, French doors, garage doors & more!



INSTALLING YOUR FLOOD GATE

By following the procedures in the correct sequence, the barrier will take approximately 2 minutes to install in position.

STEP ONE

Ensure that your entrance is smooth and clean of dust and debris at the vertical and base area in preparation for positioning.

! WARNING - Rough surfaces may damage the sleeve & leave area for possible seepage.

STEP TWO

Place the barrier with its face (see **Diagram 1**) toward the flood threat and as close as possible to your entrance in a solid reveal.

! WARNING - If you are not sure the reveal can withstand the forces that will be applied to it you **MUST** seek advice from a structural engineer.

STEP THREE

Keeping the unit in an upright position, apply downward pressure to the unit, while adjusting the horizontal scissor jack - (see **Diagram 2**).

! WARNING - Over extending the unit may weaken it and reduce its effectiveness. It is recommended that expansion be no more than 5 inches (12.7 cm). If a larger unit would fit the opening, it must be used instead of over extending a smaller unit.

STEP FOUR

Hand tighten each of the 4 downward pressure bolts to a maximum depth of ¼" (7 mm) to compact the sleeve along the ground - (see **Diagram 3**).

! WARNING - **DO NOT** fully tighten these bolts as this will cause the Flood Gate to rise off the surface & cause seepage. Only tighten enough to gently compress neoprene sleeve.

STEP FIVE

Silicone caulk may be used (see **Diagram 4**), in accordance with the manufacturer's instructions, on the exterior edges of the frame to ensure a complete seal. The use of added neoprene strips may be used to increase the water tight seal.

Diagram 1



Diagram 2

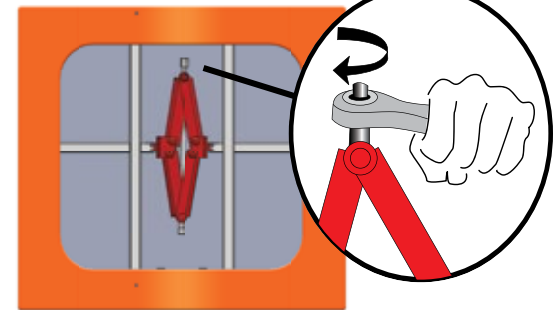
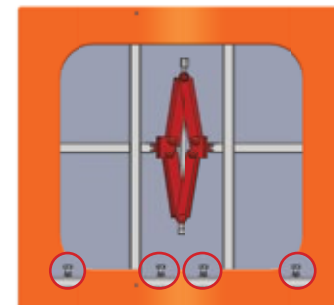
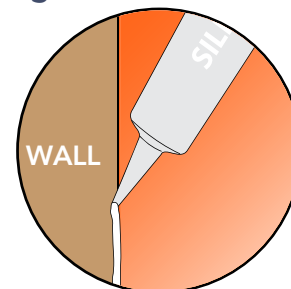

Diagram 3



Hand tighten bolts

Diagram 4



Optional for rough finish edges

SIDE RAILS

Side Rails are designed to add extra support as well as a smooth wall for a better seal.



Note: If you do NOT have a standard door that fits the Flood Gate, please review the following options to adapt your door frame to accommodate the Flood Gate

Many doors, particularly PVC doors, patio doors and French windows, are fitted almost flush with the outer face of the building. In these situations, you would need to consider how you can sufficiently extend the reveal to allow the barrier to work



Note: Where Side Rails are fitted to the wall, the sides should be sealed with caulk between the side wall & the Side Rail itself to ensure water cannot bypass between the wall & Flood Gate.

#1 Doorways With No Reveal

Use a pair of Side Rails (optional) to fit to either the reveal or the outer face of the building and provide a solid point to which the Flood Gates can fit into. (See Example 1.)

Example 1: Side Rails (optional accessory)

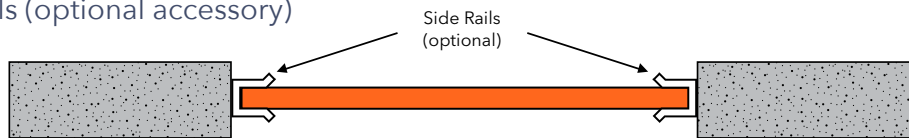

#2 No Door Frame Options

To fit the Flood Gate in a wall where the side walls are not adequate, you will need to create a side wall support of some kind, using optional Side Rails as shown in example below.

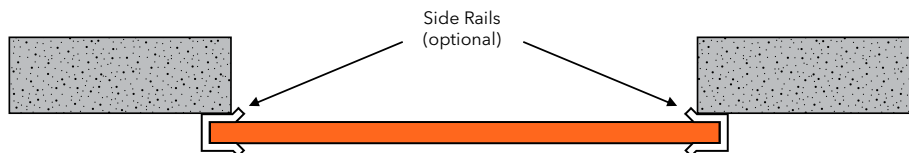

#3 Openings too wide for Flood Gates:

If opening is greater than 50in, an additional frame may be added to decrease opening size. However, please ensure that the screw heads do not protrude from the frame and stanchions may be used to connect multiple units together.

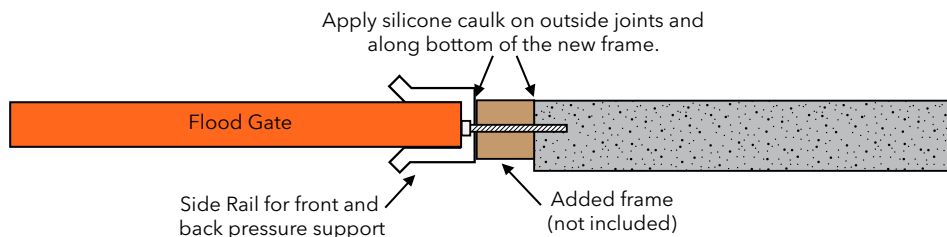

Always ensure the joints between the new frame and the existing wall/frame are 'sealed' with a water resistant silicone caulk to protect against water intrusion.

INSTRUCTIONS FOR STANCHION & SIDE RAILS

To connect multiple Flood Gates together the Stanchion set must be used

The parts shown in illustration (A) come in one kit with all of the necessary hardware. Illustration (B) shows the Side Rails that are sold in pairs.

The condition of your existing surface and installation options should be discussed with a qualified architect, engineer or contractor. General knowledge in concrete construction is necessary for this project.

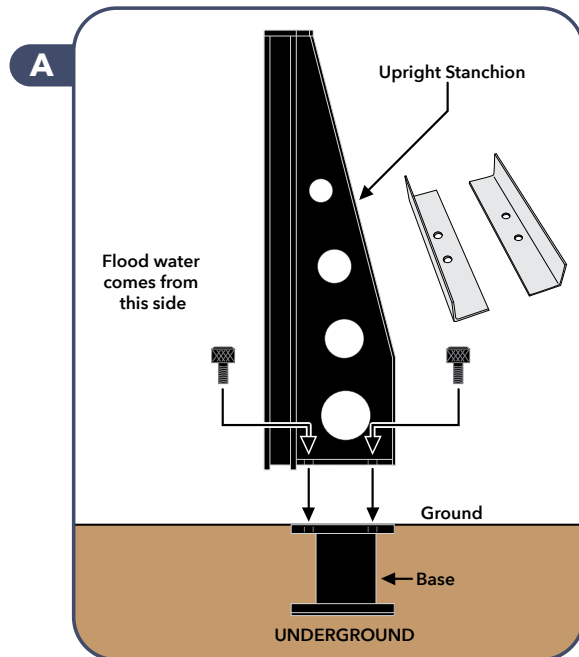

A: Upright Stanchion

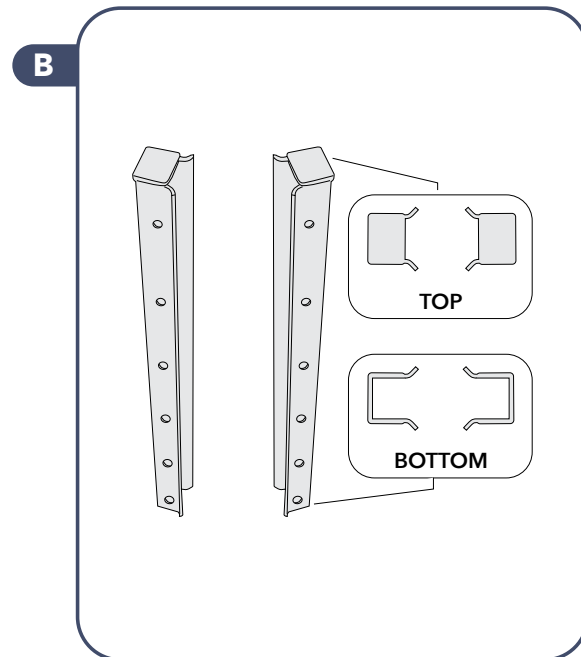

B: Side Rails

It is important that the Side Rails and Stanchions are square to the ground surface and parallel to each other.

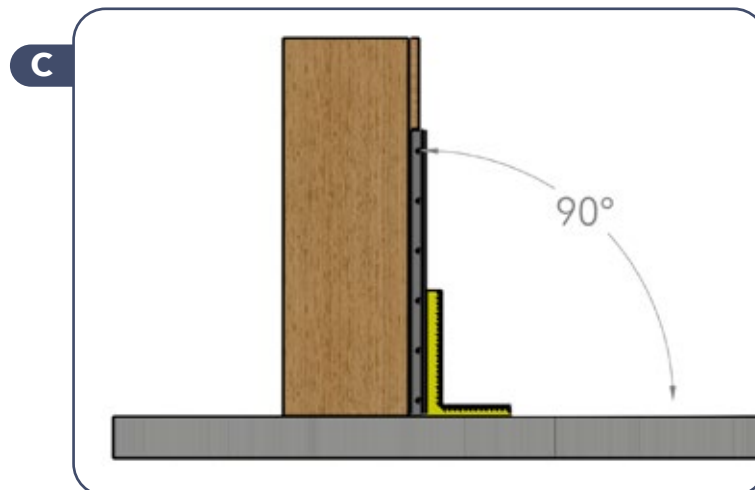

SIDE RAILS: PREPARING THE OPENING

Ensure the planning and evaluation stage is complete. Identify the products you require and carry out any remedial work that is necessary to square and even wall reveals and ground area. If your frame is not secure or is uneven, then installing side rails (optional) may be necessary.

Installing the Side Rails

Ensure the right and left jamb edges are square with the floor at least 30 inches (76 cm) high. (See illustration E and illustration F). When the corners are squared, you can install the Side Rails. (See illustration G and illustration H).



IMPORTANT: Before you drill and install the Side Rail screws, you must apply a generous coat of silicone caulk to the full length of each surface of the Side Rail where it comes in contact with the backing surfaces (e.g. reveal, doorstop, jamb plate, brick molding).

If you are fastening against a masonry surface, use a carbide tipped drill bit. Use screws suitable for wood and concrete. If threading into wood, you need to drill a pilot hole first.

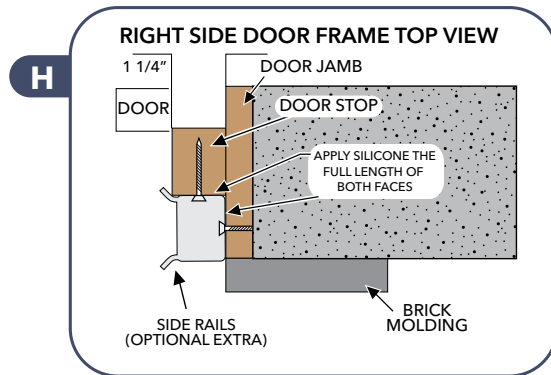
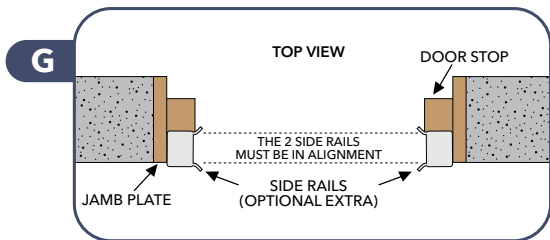
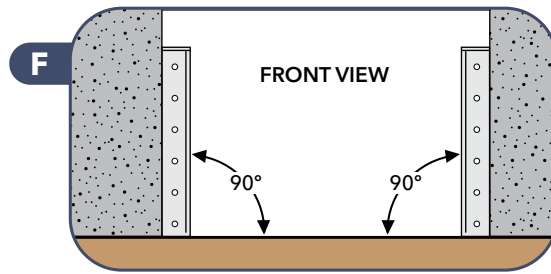
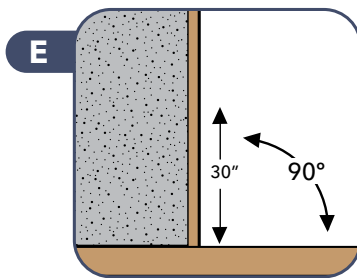
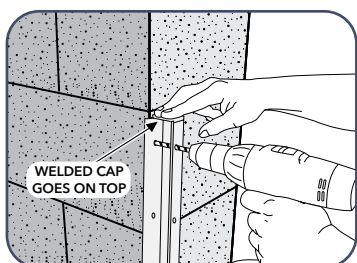

Illustration H: Screw selection will depend on the mounting surface*. For wood, use #10 x 1-1/4in wood screws suitable for outdoor use. For masonry, 3/16in flat head screws should be used. Be sure to apply silicone to all surfaces that will be screwed to the structure

**Consult with contractor for recommendations on correct hardware for cement or stone surfaces*



Note the design of the Side Rails: There is a larger access hole for the drill bit. The cap on top of the side rail prevents the Flood Gate from riding up when tightening the tension bolts on the lower edge of the Flood Gate, reducing the amount of horizontal pressure required to secure the Flood Gate in place.

It may be necessary to make filler pieces to make rails square to mounting surface.

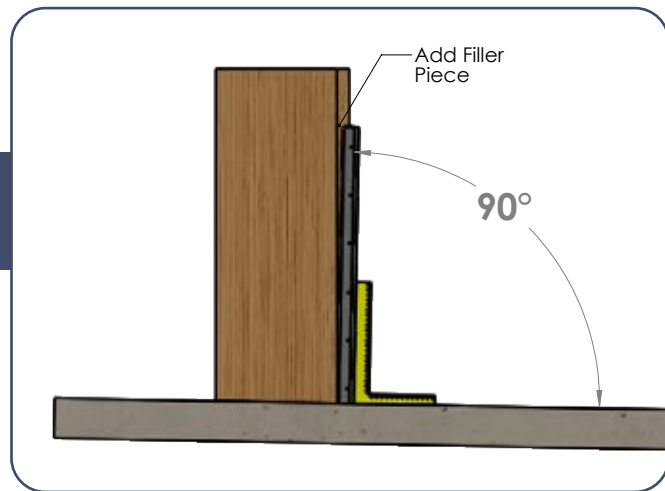

The faces of the structure adjacent to where the rails will be mounted must be parallel and in line with each other.

Correct:



Incorrect:

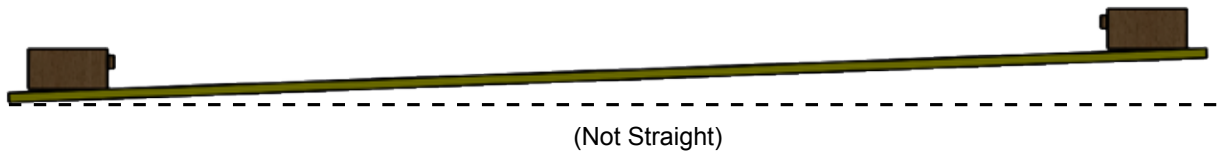

Be sure screws are flush with the inside surface of the rail leakage. Failure to do so could result in damage to the neoprene sleeve.

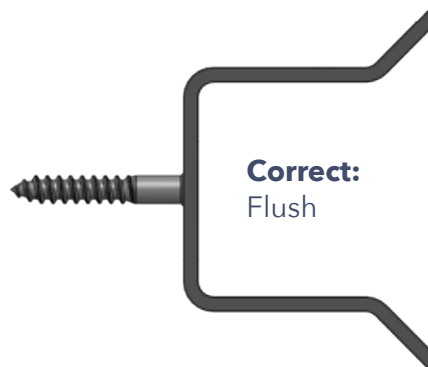
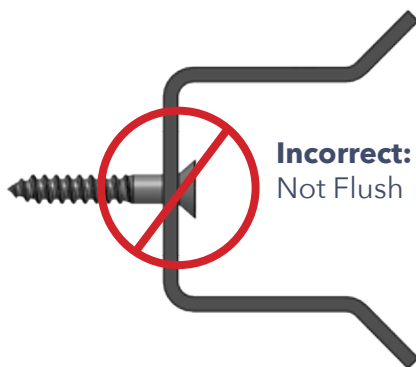

STANCHIONS: LAYING OUT THE HOLE LOCATION

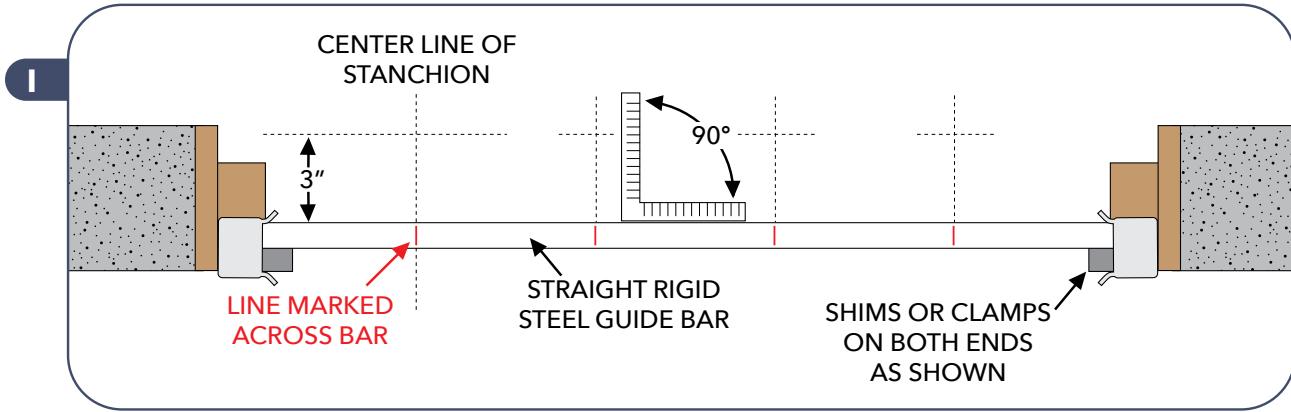

CAUTION: Whether or not you opt to use the Side Rails, the 3 in. / 76.2 mm centerline dimension of the bored Stanchion holes must always be maintained from whatever surface the back face of the Flood Gate comes into contact with on the opening.

An engineer will advise on the most appropriate method of boring the hole. Two popular methods include (but are not limited to) the use of a high pressure water saw or a diamond faced concrete hole drill.

Use a straight, rigid guide bar (not supplied), cut to the width of the door opening. A guide bar made of 1 ¼" x 1 ¼" x 1/8" (31.75 mm x 31.75 mm x 3.17 mm) angle steel or aluminum is recommended.

Mark a line across the guide bar at appropriate intervals (See illustration I in red). These marks represent the centerline spacing of the holes to be bored. The intervals depend on the mix of Flood Gate units you identified at the planning stage as the most suitable.

Lay a carpenter's square on the floor against the inner surface of the guide bar and mark a vertical line. Then measure 3in from the guide bar & mark a horizontal line. These lines become the center of each bored hole.

STANCHIONS: LAYING OUT THE HOLE LOCATION

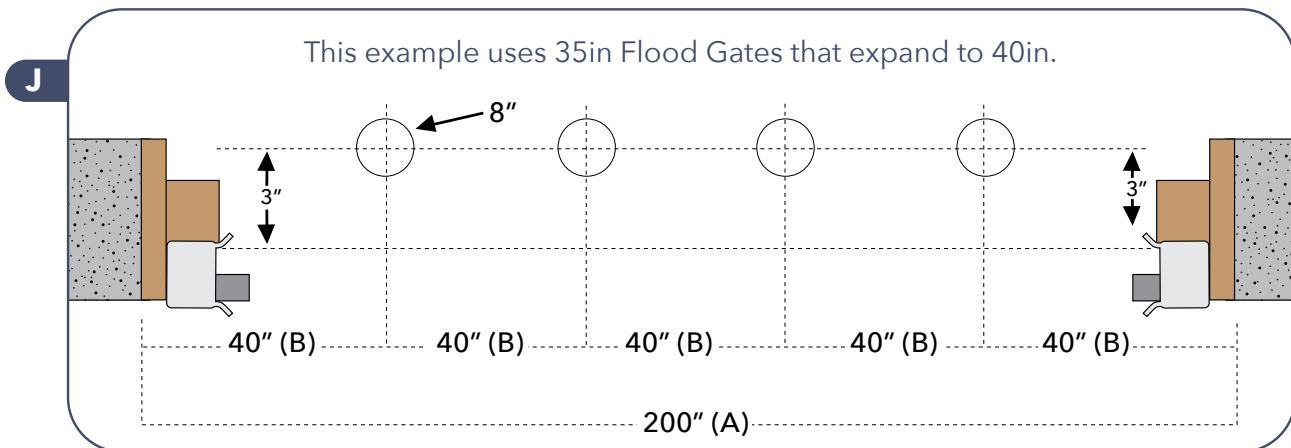

This illustration is an Example of an opening of 200in for (A). Using 5 Flood Gates, each stanchion, or dimension (B) is positioned at their respective center lines.



NOTE: The 3in/76.2mm set back dimension to the center line of the bored holes is critical to ensure proper alignment of the Flood Gate panels.

ASSEMBLING THE ANGLE BRACKETS TO THE BASE

When the holes are bored and cleaned you are ready to set up the Base.

1. Assemble the two angle brackets to the Base using the four allen head cap screws. Finger tighten at this point. (See illustration K)
NOTE: The angle brackets are used to support the Base in position while cement cures. Once cured- they will be removed & discarded. (See illustration N).
2. Using a small square adjust the front angle bracket so it's square to the top side edge of the Base. (see illustration K, L and N).
3. While holding the front angle bracket square to the Base, tighten all four cap screws.
4. Re-check the front angle bracket again with the square (see illustration L).
5. Firmly clamp or block shim each end of the rigid straight edge into the Side Rails and against the floor. Ensure that the centerline marks (which are put on to the straight edge earlier - see illustration I) are facing upward as these are the marks which you must later line up with the centerline marks scribed on to the face of the angle brackets (see illustration M).

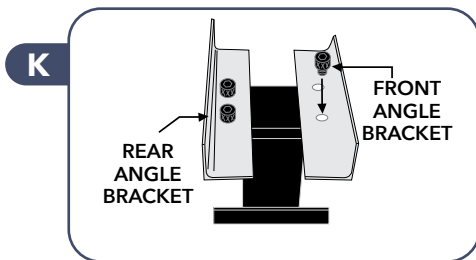

The two angles are the same, but the Front Angle Bracket is the one which is the positioning gauge for each Stanchion, therefore it must be squared with the side edge of the Base prior to tightening. (See illustration K). The Rear Angle Bracket need not be squared.

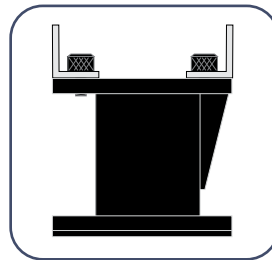

Side View

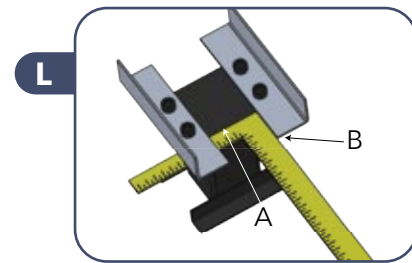

Top View: Face (A) and (B) must be square to each other as shown. A simple 6 in. square works nicely for this.

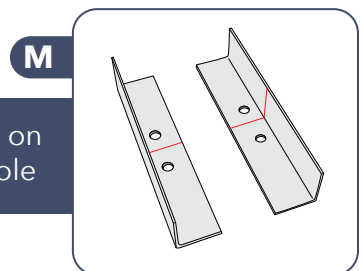

M

Once the brackets are assembled to the Base, measure and mark the centerline on each angle bracket. These lines will be used to position the Base in the bored hole

PREPARING THE GROUND SURFACE AND BASE RECESS

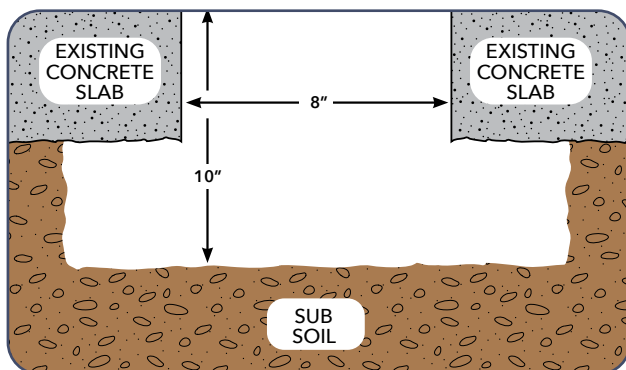

Concrete floors and slabs vary greatly in terms of thickness and type of concrete. You must create a recess beneath the surface for the anchor which is then set in the concrete foundation. With this style of construction the risk associated with under size floor thickness, cracks and inadequate concrete reinforcement is greatly reduced.

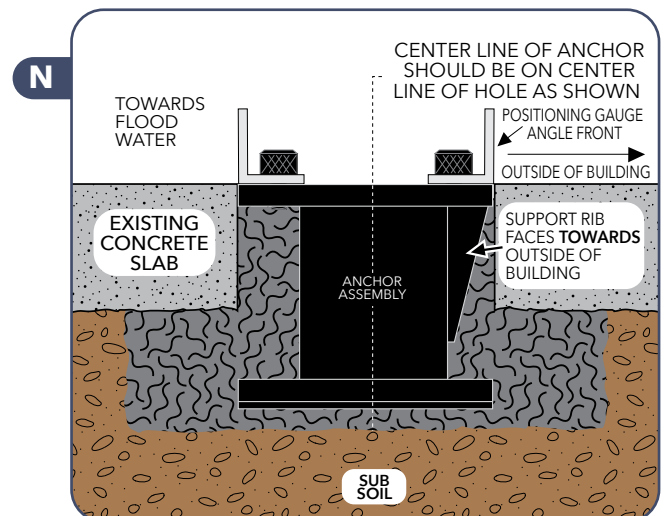

N

INSERTING BASE ASSEMBLIES

Pour and fill the hole with concrete to a depth of 4 inches from the top and tap or vibrate the concrete to ensure it completely settles at the bottom of the hole. Position the Base down into the concrete.

1. Align the center line marks on the angle brackets with the line marks on the center edge. (See illustration P).

Ensure you clamp the center line marks together so that both angle brackets are resting flat on the surface of the floor. (See illustration N).

NOTE: Each Base is designed with a 3" x 3" hollow square tube. At the very top of the tube and through its rear wall, just under the threaded plate, there is a 3/4" hole in the tube. This hole allows air to escape from the inside of the tube while the inside is filling with concrete. (See illustration O)

2. While filling with concrete, gently tap on the very center of the top of the Base with a block of wood or handle end of a hammer.

It is critical that the inside of the Base is completely filled with concrete to maintain maximum strength.

3. Ensure the top edge of angle brackets are flush with the surface of the ground.

Do not remove the clamps and angle brackets for at least 24 to 36 hours depending on the temperature, humidity and soil mechanics to allow concrete to set.

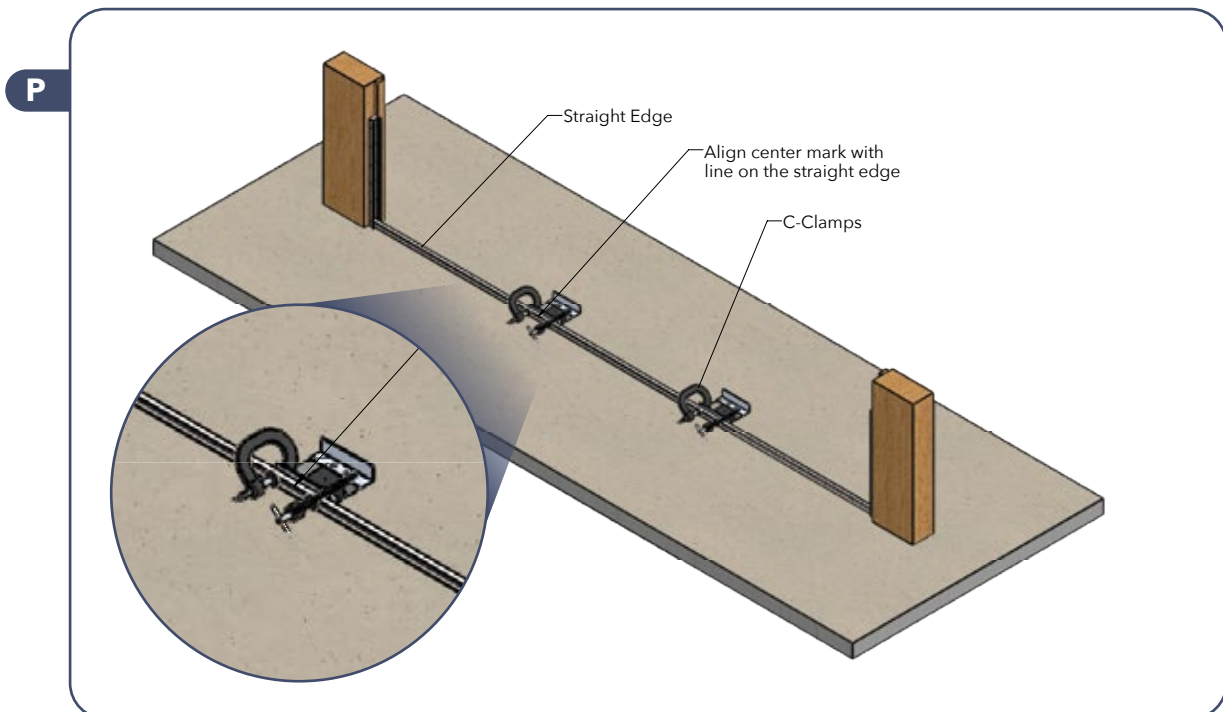
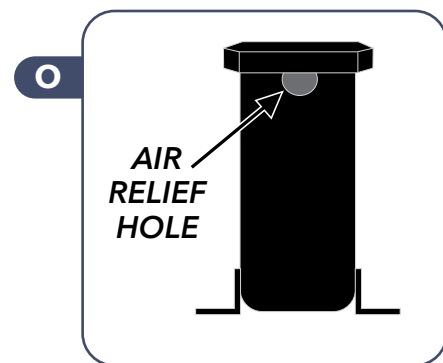

GENERAL MAINTENANCE AND INSTALLATION

Removing the clamp

Keep the allen screws and allen wrench in a safe place as they will be needed to secure the Stanchion to the Base in the event of a flood.

Maintaining the Base

1. There are (4) 1/2 in. - grub screws with every Stanchion. These must be coated with a waterproof grease or anti-seize compound and screwed into the holes on each plate. This will protect the threads in the plate and allow traffic to move across the anchor plate without damaging the threads (See illustration Q).
2. These plugs should be flush with the top of the Base and no deeper. They should also be re-greased periodically and after every use to ensure they will come out when needed.

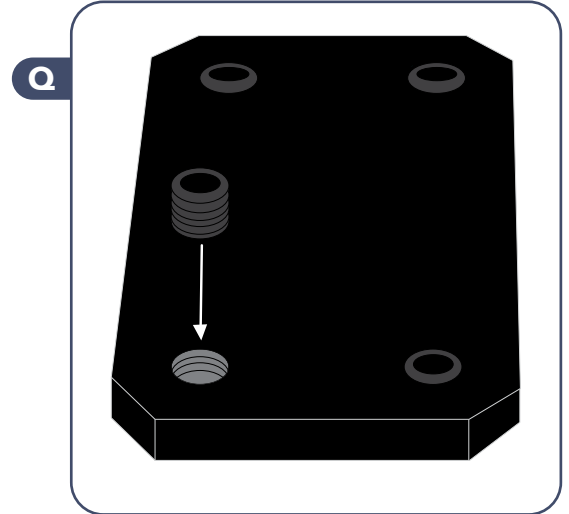

Before Installing the Stanchion



IMPORTANT: To prevent any leaking between the top of the Base and the bottom of the Stanchion there is a machined 3/16" groove which should be filled with silicone caulk to add additional sealing (See illustration R).

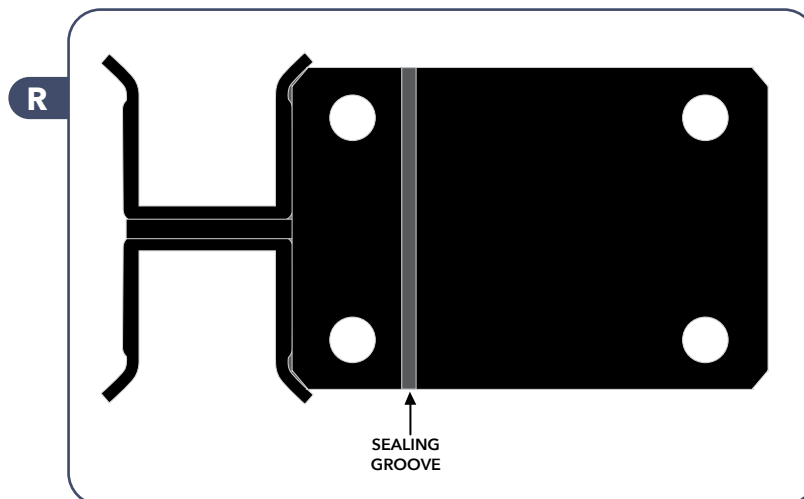

Maintaining the sealing surfaces

Always keep the top of the Base and the bottom of the Stanchion clean and free of nicks and dents as these are critical sealing surfaces.

AFTER-USE

Flood Gate Maintenance Instructions

1. Return the horizontal and vertical operating mechanisms to their closed position.
2. Remove the unit from its position.
3. Remove the sleeve and examine for damage caused by stress, use or wear and tear. Repair or replace as necessary.
4. The sleeve can be hand washed in warm water up to 104° F (40° C). Rinse in cold water and hang to dry in shaded area. DO NOT TUMBLE DRY.
5. Dry off excess moisture from the metal frame. Examine for damage caused by stress, use or wear and tear. **Apply rust proofing oil or grease to all expandable mechanisms.**
6. Once all parts of the unit are dry, the unit can be stored for future use.

Storing your Flood Gate

1. Store the unit in a secure location and only allow access by a responsible adult.
2. The unit should be stored in its closed and upright position. DO NOT STORE IN AN EXPANDED STATE.
3. Store the unit and its accessories in a dry and well ventilated area. DO NOT STORE IN DIRECT SUNLIGHT.
4. DO NOT EXPOSE THE PRODUCT TO EXTREME TEMPERATURES AND KEEP AWAY FROM OPEN FLAMES.
5. Place the unit in storage in it's normal upright position, keeping the sleeve separate & flat to maintain it's shape.
6. If you are storing more than one unit and do not intend on using the original packaging, the gates must be stored face to face (The face as shown in Diagram A).
7. DO NOT STORE FACE TO BACK OR BACK TO BACK AS THIS CAN DAMAGE THE PRODUCTS.
8. Review the unit and its mechanisms periodically to ensure that the conditions of storage have not reduced its effectiveness.

TERMS & CONDITIONS

Flood Gate is intended to be used as outlined in this document and other Absorbent Specialty Products (ASP) literature. Data and information provided in this document is for general information purposes only. Conditions for each use of the Flood Gate will vary and are beyond the control of ASP. ASP cannot guarantee desired results. When purchasing this product from ASP, you agree to assume all risks that may arise from ownership, installation, and use of the Flood Gate and agree to release ASP from any and all claims brought by any person or entity against ASP related to and/or arising from your ownership, installation, and/or use of the Flood Gate. ASP shall not be liable for any improper or incorrect ownership, installation or use of this product and assumes no responsibility for anyone's ownership, installation or use of this product. In no event shall ASP be liable for any direct, indirect, incidental, special, exemplary or consequential damages (including, but not limited to: procurement or substitute goods or services; loss of use or profits; or business interruption) however caused and on any theory arising in any way out of the use of this product, even if advised of the possibility of such damage. This disclaimer of liability applies to any damages, injury or death, whether based on alleged breach of contract, tortious behavior, negligence or any other cause of action, including and not limited to damages or injuries caused by any failure of performance, error, omission, defect or delay in operation.

LIMITED WARRANTY











ASP warrants this product and components to be free from defects in material and workmanship for a period of one (1) year from date of shipment. If within the term of this warranty, if any Flood Gate component is found to be defective upon inspection by an authorized Flood Gate representative, ASP will replace or repair, at ASP's discretion, any part found to be defective. Unauthorized modification of this product voids this limited warranty. The neoprene sleeve is considered a "wear-item" and is not covered under this warranty. Replacements can be purchased from ASP. Moving parts must be properly maintained prior to storage.

To make a claim under this warranty, contact ASP at this address:

Absorbent Specialty Products | 1 John C. Dean Memorial Blvd. | Cumberland, RI 02864 | 888-761-4405 | info@absorbbsp.com



PROTECTING THESE INDUSTRIES

- 
Government
- 
Property Management
- 
Construction
- 
Universities
- 
Hospitals
- 
Janitorial
- 
Hotels
- 
Retail
- 
Grocery
- 
Residential

& MORE

Visit us at www.quickdams.com or call 888-761-4405