



# HVLS 108

## BLDC HVLS CEILING FAN

### Installation Guide

v. 1.2 (US) | Dec 2020

For help, call 1-800-433-1626 or  
visit [www.MYMAXXAIR.com](http://www.MYMAXXAIR.com)

# **READ THE ENTIRE MANUAL AND SAVE THE INSTRUCTIONS**

THE FAN IS TO BE INSTALLED SO THAT THE BLADES ARE MORE THAN 10 FEET ABOVE THE FLOOR

THE MINIMUM CLEARANCE OF THE TIP OF BLADES FROM ANY OBSTRUCTIONS INCLUDING LIGHTS, WALLS OR STRUCTURES SHALL BE A MINIMUM OF 20 INCHES.

WARNING - TO REDUCE THE RISK OF FIRE, ELECTRIC SHOCK, OR PERSONAL INJURY, MOUNT DIRECTLY TO A STRUCTURAL FRAMING MEMBER.

WARNING - TO REDUCE THE RISK OF PERSONAL INJURY, DO NOT BEND THE BLADE BRACKETS WHEN INSTALLING THE BRACKETS, BALANCING THE BLADES, OR CLEANING THE FAN. DO NOT INSERT FOREIGN OBJECTS IN BETWEEN ROTATING FAN BLADES.

WARNING - TO REDUCE THE RISK OF FIRE, ELECTRIC SHOCK, OR PERSONAL INJURY, DO NOT ATTEMPT TO OPEN OR REPAIR ANY PARTS OR COMPONENTS OF THE FAN.

WARNING - TO REDUCE THE RISK OF FIRE, ELECTRIC SHOCK, OR PERSONAL INJURY, DO NOT OPERATE THE FAN IF ANY PARTS OF IT IS DAMAGED OR APPEARS TO BE DAMAGED.

WARNING - TO REDUCE THE RISK OF FIRE, ELECTRIC SHOCK, OR PERSONAL INJURY, ALL WIRING MUST BE IN ACCORDANCE WITH THE NATIONAL ELECTRICAL CODE, ANSI/NFPA 70.

WARNING - TO REDUCE THE RISK OF FIRE, ELECTRIC SHOCK, OR PERSONAL INJURY, DO NOT ATTEMPT TO OPEN OR TOUCH ANY OF THE ELECTRONICS INSIDE THE CONTROL BOX AS MANY OF THE PARTS OPERATE AT LIVE VOLTAGE.

WARNING - TO REDUCE THE RISK OF FIRE, ELECTRIC SHOCK, AND INJURY TO PERSONS, THE FAN MUST BE INSTALLED WITH THE BLADES THAT ARE MARKED (ON THEIR CARTONS) TO INDICATE THE SUITABILITY WITH THIS MODEL. OTHER BLADES CANNOT BE SUBSTITUTED.

WARNING - TO REDUCE THE RISK OF FIRE, ELECTRIC SHOCK, OR PERSONAL INJURY, THE FAN SUSPENSION SYSTEM SHALL BE INSPECTED REGULARLY OR AT LEAST ONCE EVERY TWO YEARS.

FOR HELP, CALL 1-800-433-1626  
OR VISIT  
[WWW.MYMAXXAIR.COM](http://WWW.MYMAXXAIR.COM)

WARNING - MAKE SURE THE POWER SUPPLY IS OFF BEFORE ATTEMPTING INSTALLATION

WARNING - TO REDUCE THE RISK OF FIRE, ELECTRIC SHOCK OR IJNURY TO PERSONS, UNPLUG OR DISCONNECT THE APPLIANCE FROM THE POWER SUPPLY BEFORE THE FAN INSTALLATION, CLEANING OR SERVICING.

WARNING - TO REDUCE THE RISK OF ELECTRIC SHOCK, THIS FAN MUST BE INSTALLED WITH A GENERAL-USE, ISOLATING WALL CONTROL/SWITCH.

ALL SET SCREWS MUST BE CHECKED AND RE-TIGHTENED WHERE NECESSARY, BEFORE INSTALLATION.

AFTER MAKING THE WIRE CONNECTIONS, THE WIRES SHOULD BE SPREAD APART WITH THE GROUNDED CONDUCTOR AND THE EQUIPMENT-GROUNDING CONDUCTOR ON ONE SIDE OF THE OUTLET BOX AND THE UNGROUNDED CONDUCTOR ON THE OTHER SIDE OF THE OUTLET BOX.

THE SPLICES AFTER BEING MADE SHOULD BE TURNED UPWARD AND PUSHED CAREFULLY UP INTO THE CANOPY.

CONDUCTOR OF A FAN IDENTIFIED AS GROUNDED CONDUCTOR TO BE CONNECTED TO A GROUNDED CONDUCTOR OF POWER SUPPLY, CONDUCTOR OF FAN IDENTIFIED AS UNGROUNDED CONDUCTOR TO BE CONNECTED TO AN UNGROUNDED CONDUCTOR OF POWER SUPPLY, CONDUCTOR OF FAN IDENTIFIED FOR EQUIPMENT GROUNDING TO BE CONNECTED TO AN EQUIPMENT-GROUNDING CONDUCTOR.

FAN MODEL NO.: HVLS 108  
WEIGHT OF FAN: 60 LBS

<b>Model</b>	<b>Diameter</b>	<b>Input Power</b>	<b>Rated Current</b>
HVLS 108	9 FT	120 VAC 60 Hz	2 A

### Recommended Tools

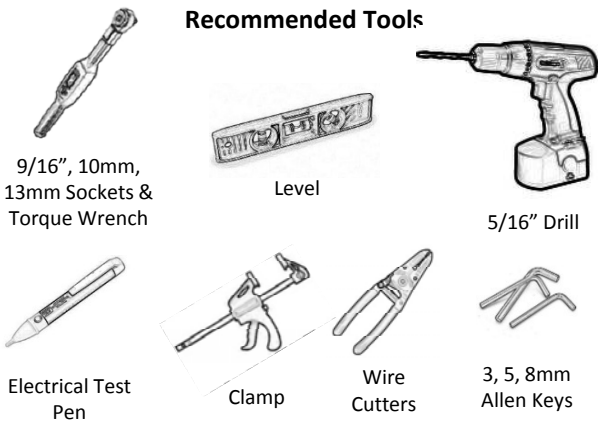

### Mount the Ceiling Bracket

#### 1A. Mounted on Wood Framed Ceiling

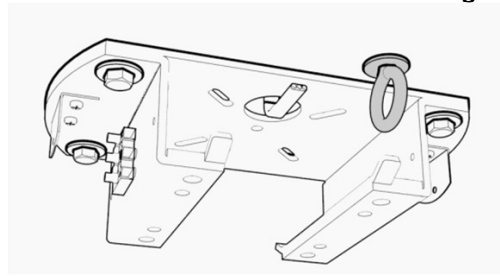

Mount the ceiling bracket using (4) 3/8" or equivalent lag screws . Install the closed eye bolt for safety cable. Ensure eye screw can be covered by the canopy cover.  
**MAX TORQUE FOR ANCHOR/SAFETY BOLTS: 25Nm**

### 3. Assemble Mounting Bracket to Hanger Tube

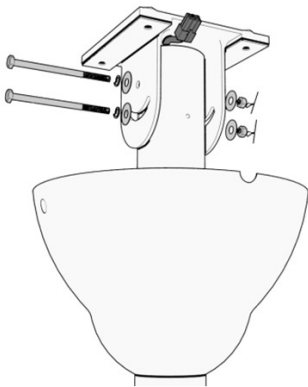

Ensure the canopy cover is inserted into the hanger tube before assembling the mounting bracket to the hanger tube.

The 2 bolts should be secure but not fully tightened to allow the hanger tube to naturally swing into a vertical position after Step 5.

### 4. Secure Fan Assembly to the Ceiling Bracket

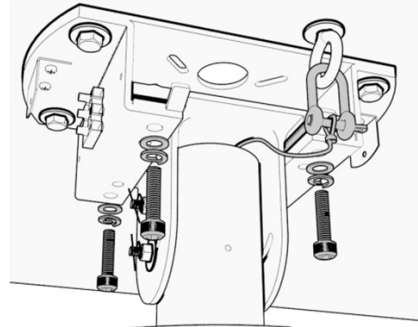

Lift the fan assembly and place it within the ceiling bracket. Secure fan using the bolts and washers provided. **Secure the safety cable into the eye bolt with the shackle. Ensure the safety cable has a slack of 12" to 16".**

### 7. Grounding Wire Connections

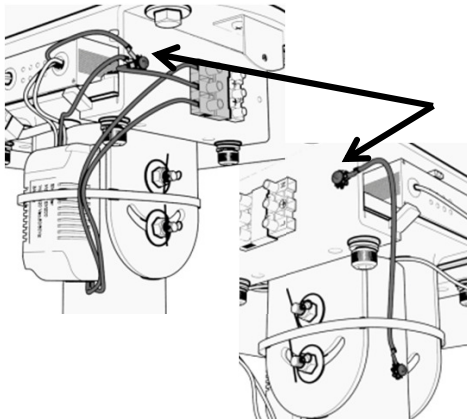

Connect the grounding wires to the ceiling bracket as shown.

### 8. Connect to Mains

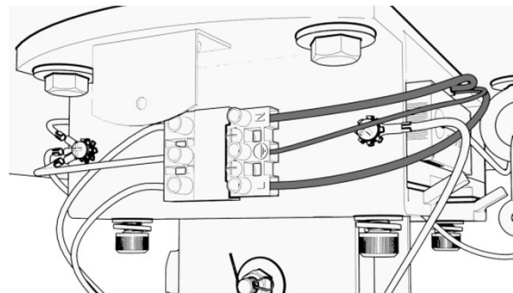

#### **WARNING- ENSURE MAINS POWER IS DIS-CONNECTED**

Connect to Mains - Ground wire first, followed by Neutral and Live. Plug in connector firmly.

See wiring diagram on next page.

### 11. Un-secure Fan Blade Mount Plate

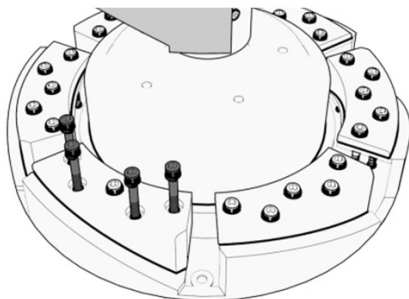

Unsecure the upper fan blade mount by removing the 4 bolts. Loosen the middle bolt.  
**DO NOT REMOVE THE LOWER FAN BLADE MOUNT!**

### 12. Installing the Fan Blade

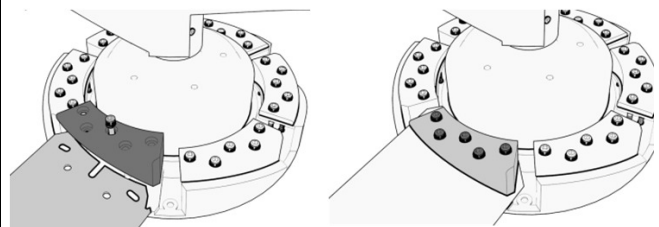

Push the fan blade towards the motor and secure the fan blade using the upper fan blade mount and the 5 bolts. Repeat this with the remaining fan blades.

**1B. Do NOT mount only to a fan junction box. The (4) outer holes must be used to secure the bracket to the ceiling.**

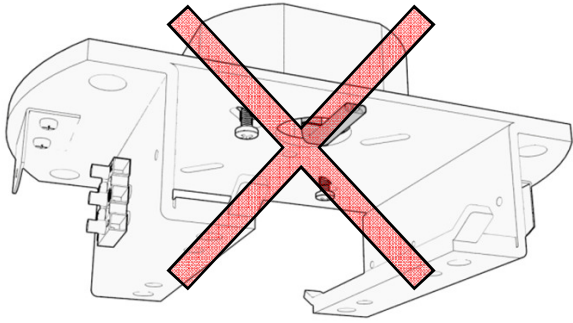

## 2. Connecting the Hanger Tube to Motor

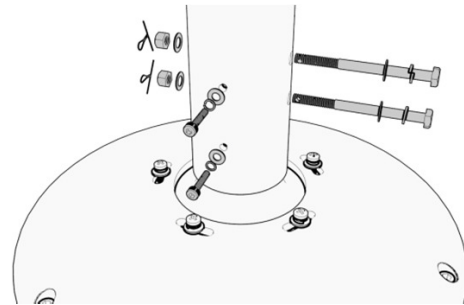

With the hanger tube aligned to the motor shaft, tighten the 2 bolts and 2 screws to secure the assembly. Install and expand the cotter pins.

**RECOMMENDED TORQUE: M4 - 2Nm, M6 – 14Nm**

## 5. Securing the Hanger Tube

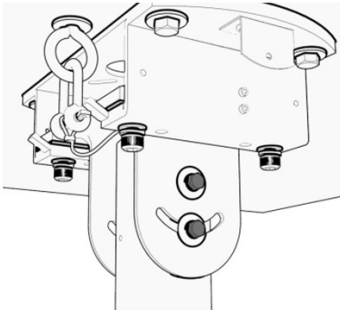

Adjust the hanger tube to be perpendicular to the ground. Fully tighten the 2 upper hanger tube bolts to secure the hanger tube.

## 6. Installing the Motor Controller Box

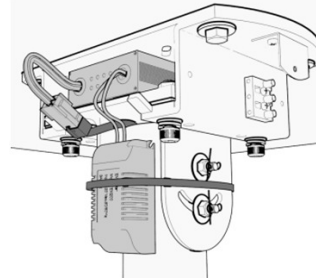

Insert the motor controller box into the fan mount. Secure the box using the double sided tape provided. Connect the wire harness to the terminal block.

## 9. Secure the Top Canopy

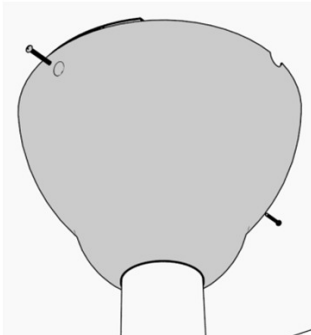

Raise the top canopy and secure it using the screws on both sides of the canopy..

## 10. Un-securing the Motor Cover to install the blades

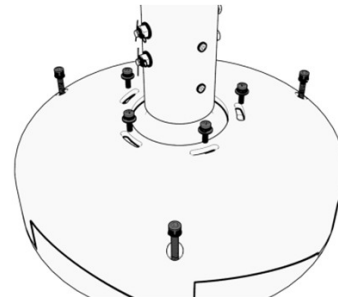

Remove the 5 inner screws followed by the 3 outer bolts to unsecure the motor cover. Lift and secure the motor cover with clamp to expose the motor assembly.

## 13. Repositioning the Motor Cover

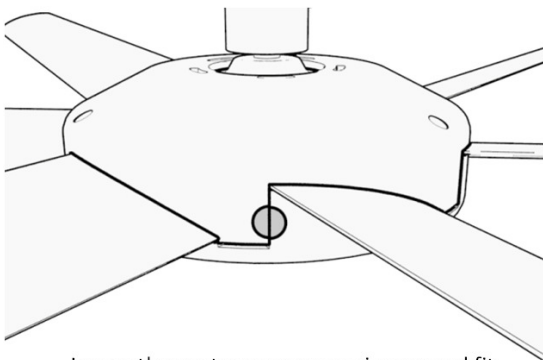

Lower the motor cover ensuring a good fit.  
**NOTE THAT THE COLOUR POSITIONING MARKERS ARE TO BE ALIGNED.**

## 14. Securing the Motor Cover



To secure the motor cover, insert and tighten the 3 outer bolts followed by the 5 inner screws. Rotate the fan by hand to check for problems.  
**You are now ready to power up the fan.**



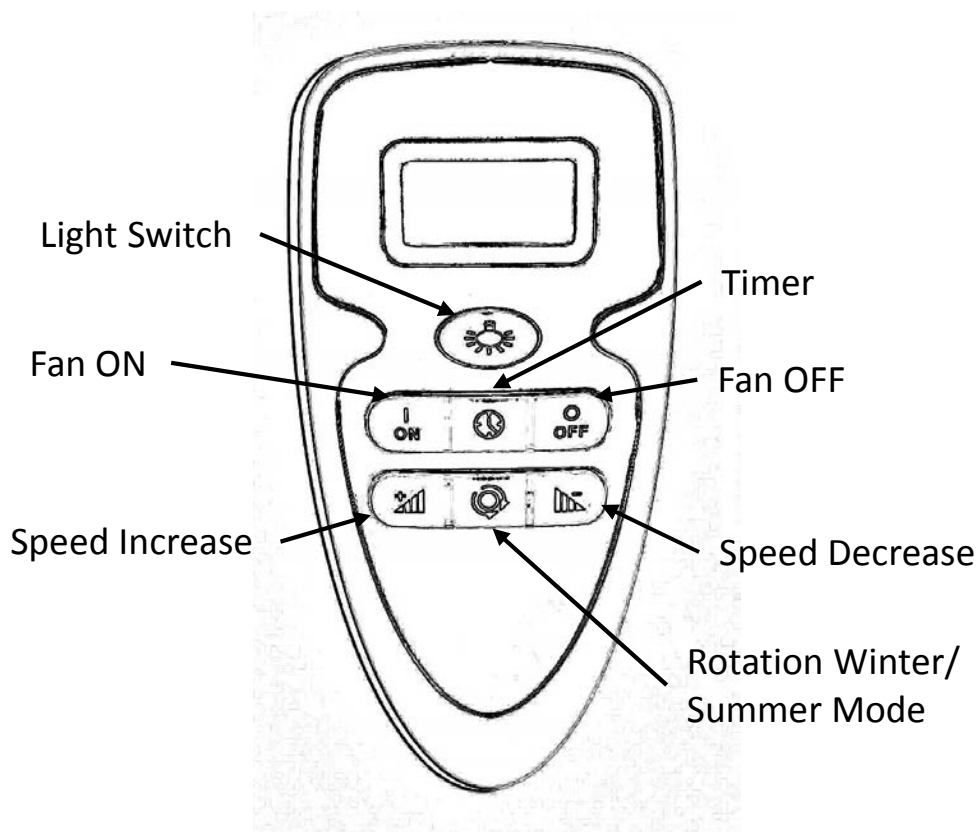



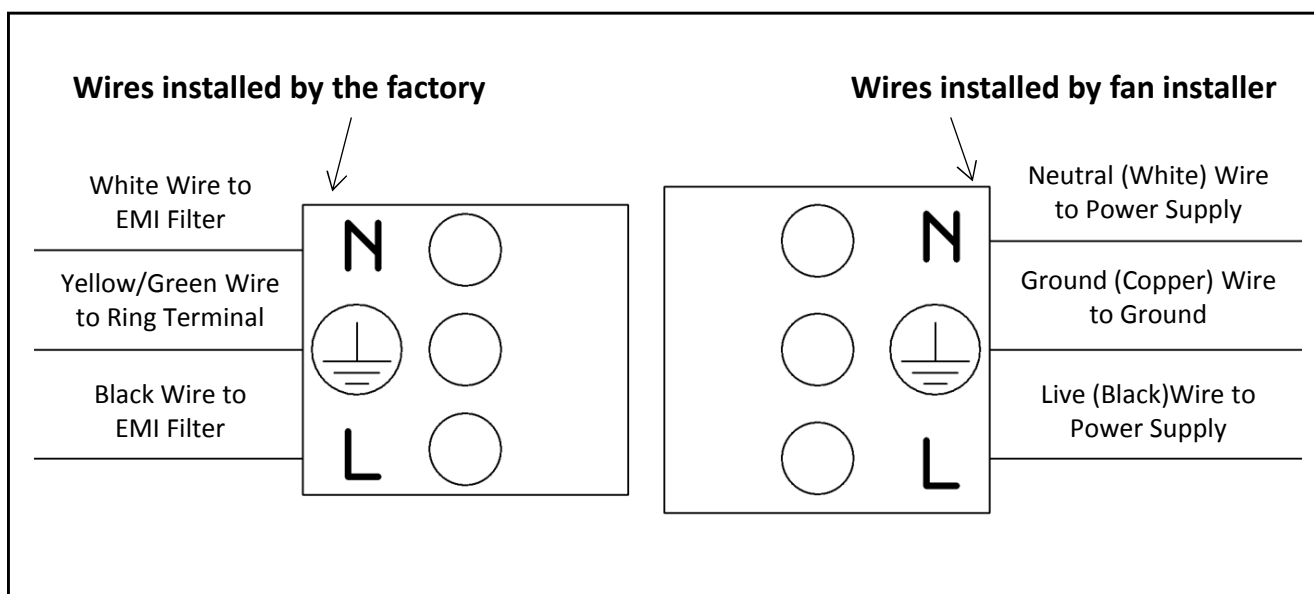

# FAN REMOTE CONTROLLER

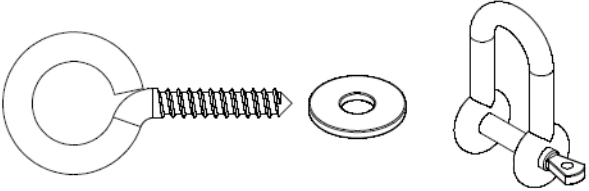
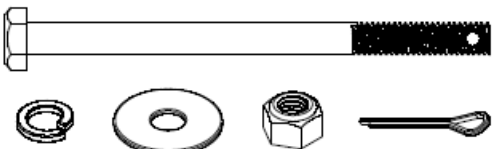
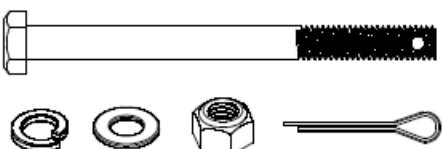

## WIRING DIAGRAM

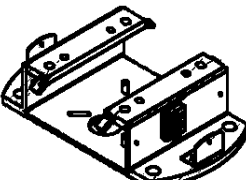

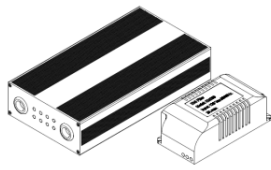
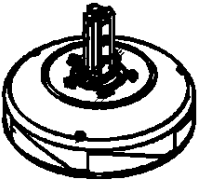
# Parts List

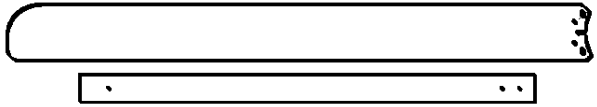
			
<p><b>Ceiling Bracket Hardware</b>            (4) 3/8" LAG SCREW            (4) 3/8" FLAT WASHER</p>		<p><b>Safety Cable Hardware</b>            (1) 3/8" EYE LAG SCREW            (1) 3/8" FLAT WASHER            (1) SAFETY CABLE SHACKLE</p>	
			
<p><b>Tube Bracket Hardware</b>            (2) M6-1 X 85MM            (2) M6 SPLIT WASHER            (4) M6 FENDER WASHER            (2) M6 NYLOCK NUT            (2) COTTER PIN</p>		<p><b>Motor Mount Hardware</b>            (2) M6-1 X 75MM            (2) M6 SPLIT WASHER            (4) M6 FLAT WASHER            (2) M6 NYLOCK NUT            (2) COTTER PIN</p>	
			
<p><b>Wiring Cover Hardware</b>            (2) M4-0.7 X 20MM</p>		<p><b>Earth Wire Mount (Controller)</b>            (1) M4-0.7 X 5MM            (2) M4 EXT TOOTH</p>	<p><b>Earth Wire Mount (Incoming)</b>            (1) M4-0.7 X 5MM            (2) M4 EXT TOOTH</p>
			
<p>(1) Ceiling Bracket</p>	<p>(1) Mounting Bracket</p>	<p>(1) Controller Box</p>	
			
<p>(1) Motor</p>	<p>(1) Canopy Cover</p>	<p>(6) Blades            (1) Hanger Tube</p>	
<p>*Remote, batteries and safety cable included but not shown.</p>			

# WARRANTY

This warranty is underwritten by Falco Insurance Company and is extended to the original retail purchaser of this model or, if this unit is purchased and requires installation by a building contractor, to the original owner of the home. No subsequent purchaser of the unit or of a home in which it is installed is entitled to any of the benefits of this warranty.

This product is warranted against defects in materials and workmanship for a period of one (1) year from the date of original retail purchase. No other parts or components are warranted. There is no warranty for defects caused by abuse, faulty installation, or the like.

Repairs or replacement parts supplied under this warranty are warranted only for the period of this warranty; that is, one (1) year from the date of the original retail purchase of the unit.

In the event of a defect or malfunction, we will replace or repair the defective part or component only and return the new or repaired part to you freight prepaid.

You must bear all other expenses incurred in obtaining repairs, including labor required for field repair or replacement, and the cost of shipping the defective part to us. You must also bear the cost of repair to or replacement of any part or component and the shipping charges incurred for the repair or replacement and return to you of any part or component not covered by this warranty, including parts or components damaged by you.

The company reserves the right to demand and receive written evidence of the date of purchase before undertaking its obligations under this warranty. The right to demand and receive written evidence of date of purchase extends to all licensed dealers of Ventamatic, Ltd. products.

You should, therefore, retain your sales slip and attach a copy of it to the warranty claim.

To start a warranty claim you must:

Contact Ventamatic, Ltd.

An RGA (Returned Goods Authorization) form is required for returns to the factory to ensure your return can be processed efficiently and quickly. Please contact Ventamatic, Ltd. toll-free at 800-433-1626 or via web at [www.MYMAXXAIR.com](http://www.MYMAXXAIR.com) to obtain an RGA and follow the instructions given.

There is no informal dispute settling mechanism available in the event of a controversy involving this warranty.

Any and all implied warranties which may exist terminate upon the expiration of this warranty one (1) year from the date of the original retail purchase. Some states do not allow limitations on how long an implied warranty lasts, so this limitation may not apply to you.

Ventamatic, Ltd. is not liable to you for incidental or consequential damages arising out of defect or malfunction of a unit or its installation or out of any alleged breach of this warranty. Some states do not allow the exclusion or limitation of incidental or consequential damages, so this limitation may not apply to you.

This warranty gives you specific legal rights and you may also have other rights which may vary from state to state.