

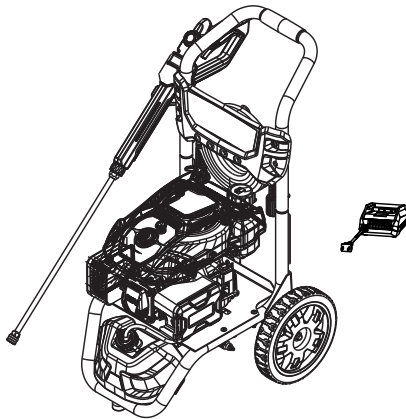

Power Washer
Owner's Manual



MODEL: _____

SERIAL: _____

DATE PURCHASED: _____

Register your Generac product at:
WWW.GENERAC.COM
1-888-GENERAC
(1-888-436-3722)

SAVE THIS MANUAL FOR FUTURE REFERENCE

Table of Contents

Section 1 Introduction and Safety 1

Introduction	1
Safety Rules	1
Safety Symbols and Meanings	2

Section 2 General Information and Setup 3

Know Your Power Washer	3
Emissions	3
Remove Contents from Carton	3
Assembly	3
Add Engine Oil	4
Fuel	4
Water Supply	5
Connect Water Supply	5
Connect High-Pressure Hose and Lance	5
Spray Gun	6
Nozzles	6

Section 3 Operation 7

Operation and Use Questions	7
Before Starting Engine	7
Prepare Power Washer for Use	7
Electric Start	8

Power Washer Start-Up	8
Power Washer Shut Down	9
Apply Detergent	9
Rinsing	9
Clean Detergent Siphoning Tube	9
Automatic Cool Down System (Thermal Relief)	10

Section 4 Maintenance and Troubleshooting 11

Maintenance	11
Maintenance Schedule	11
Pump Oil	11
Preventive Maintenance	11
Engine Maintenance	12
Service Spark Plug	13
Maintaining the Battery	14
Storage	15

WARNING

Operating, servicing and maintaining this equipment can expose you to chemicals including engine exhaust, carbon monoxide, phthalates, and lead, which are known to the State of California to cause cancer and birth defects or other reproductive harm. To minimize exposure, avoid breathing exhaust, do not idle the engine except as necessary, service your equipment in a well-ventilated area and wear gloves or wash your hands frequently when servicing your equipment.

For more information go to
www.P65Warnings.ca.gov.

(000393)

Section 1 Introduction and Safety

Introduction



WARNING

Consult Manual. Read and understand manual completely before using product. Failure to completely understand manual and product could result in death or serious injury. (000100a)

Thank you for purchasing a Generac Power Systems Inc. product. This unit has been designed to provide high performance, efficient operation, and years of use when maintained properly.

If any section of the manual is not understood, contact your nearest Independent Authorized Service Dealer (IASD), or contact Generac Customer Service at 1-888-GENERAC (1-888-436-3722), or <http://www.generac.com/> with any questions or concerns.

The owner is responsible for proper maintenance and safe use of the equipment. Before operating, servicing or storing this power washer:

- Study all warnings in this manual and on the product carefully.
- Become familiar with this manual and the unit before use.
- Refer to the **Assembly** section of the manual for instructions on final assembly procedures. Follow the instructions completely.

Save these instructions for future reference. ALWAYS supply this manual to any individual that will use this machine.

The information in this manual is accurate based on products produced at the time of publication. The manufacturer reserves the right to make technical updates, corrections, and product revisions at any time without notice.

Safety Rules

The manufacturer cannot anticipate every possible circumstance that might involve a hazard. The warnings in this manual, and on tags and decals affixed to the unit are, therefore, not all inclusive. If using a procedure, work method or operating technique that the manufacturer does not specifically recommend, verify that it is safe for others. Also make sure the procedure, work method or operating technique utilized does not render the equipment unsafe.

Throughout this publication, and on tags and decals affixed to the generator, DANGER, WARNING, CAUTION and NOTE blocks are used to alert personnel to special instructions about a particular operation that may be hazardous if performed incorrectly or carelessly. Observe them carefully. Their definitions are as follows:

DANGER

Indicates a hazardous situation which, if not avoided, will result in death or serious injury.

(000001)

WARNING

Indicates a hazardous situation which, if not avoided, could result in death or serious injury.

(000002)

CAUTION

Indicates a hazardous situation which, if not avoided, could result in minor or moderate injury.

(000003)

NOTE: Notes contain additional information important to a procedure and will be found within the regular text of this manual.

These safety warnings cannot eliminate the hazards that they indicate. Common sense and strict compliance with the special instructions while performing the action or service are essential to preventing accidents.

Safety Symbols and Meanings



▲DANGER

Asphyxiation. Running engines produce carbon monoxide, a colorless, odorless, poisonous gas. Carbon monoxide, if not avoided, will result in death or serious injury. (000103)



▲DANGER

Electrocution. Water contact with a power source, if not avoided, will result in death or serious injury. (000104)



▲DANGER

Explosion and Fire. Fuel and vapors are extremely flammable and explosive. Add fuel in a well ventilated area. Keep fire and spark away. Failure to do so will result in death or serious injury. (000105)



▲WARNING

Fluid Injection. This machine produces high-pressure fluid streams that can pierce skin. Fluid injection could result in death or serious injury. (000106b)



▲WARNING

Risk of Fire. Hot surfaces could ignite combustibles, resulting in fire. Fire could result in death or serious injury. (000110)



▲WARNING

Vision Loss. Eye goggles are required to be worn when using this machine. Failure to wear eye goggles could result in permanent vision loss. (000101)



▲WARNING

Hearing Loss. Hearing protection is recommended when using this machine. Failure to wear hearing protection could result in permanent hearing loss. (000107)



▲WARNING

Hot Surfaces. When operating machine, do not touch hot surfaces. Keep machine away from combustibles during use. Hot surfaces could result in severe burns or fire. (000108)



▲WARNING

Risk of Fire. Verify machine has properly cooled before installing cover and storing machine. Hot surfaces could result in fire. (000109)



▲WARNING

Moving Parts. Keep clothing, hair, and appendages away from moving parts. Failure to do so could result in death or serious injury. (000111)



▲WARNING

Risk of Falling. Use of machine creates wet areas and trip hazards. Be aware of work area conditions. A fall could result in death or serious injury. (000112)



▲WARNING

Risk of Falling. Do not use this machine or any components on elevated surfaces. Doing so can result in a fall, serious injury, or death. (000114)



▲WARNING

Recoil Hazard. Recoil could retract unexpectedly if water pressure is not properly relieved from pump, creating kickback. Kickback could result in death or serious injury. (000113)



▲WARNING

Consult Manual. Read and understand manual completely before using product. Failure to completely understand manual and product could result in death or serious injury. (000100a)



▲WARNING

Moving Parts. Do not wear jewelry when starting or operating this product. Wearing jewelry while starting or operating this product could result in death or serious injury. (000115)



▲WARNING

Personal injury. Risk of fluid injection. Do not aim spray gun at people, animals, electrical devices, or fragile items. Keep out of reach of children. Failure to do so could cause death or serious injury. (000117c)

▲WARNING

Environmental Hazard. Always recycle batteries at an official recycling center in accordance with all local laws and regulations. Failure to do so could result in environmental damage, death or serious injury. (000228)

▲WARNING

Personal Injury / Equipment Damage. Place wand in holster and verify that handle is locked into place before moving. Failure to do so could result in death, serious injury, or equipment damage. (000244)

Section 2 General Information and Setup

Know Your Power Washer



WARNING

Consult Manual. Read and understand manual completely before using product. Failure to completely understand manual and product could result in death or serious injury. (000100a)

Read this manual thoroughly before assembling and operating this unit. Save this manual for future and immediate reference. Replacement owner's manuals are available at www.generac.com.

Emissions

The United States Environmental Protection Agency (US EPA) (and California Air Resources Board (CARB), for engines/equipment certified to California standards) requires that this engine/equipment complies with exhaust and evaporative emissions standards. Locate the emissions compliance decal on the engine to determine applicable standards. For emissions warranty information, please reference the included emissions warranty. It is important to follow the maintenance specifications in the manual to ensure that the engine complies with the applicable emissions standards for the duration of the product's life.

Remove Contents from Carton

1. Open carton completely by cutting each corner from top to bottom.
2. Remove and verify carton contents prior to assembly. Carton contents should contain one each of the following:
 - Main Unit
 - Handle Assembly
 - High-pressure Hose
 - Spray Gun
 - Lance
 - Gun Hook and Tree Clips
 - Oil
 - Hose Hook Wireform
 - Battery
 - Battery Charger
 - Parts Bag (includes):
 - Owner's Manual
 - Bag of Colored Nozzles
 - Register your product at <https://register.generac.com/>
3. Call Generac Customer Service at 1-888-GENERAC (1-888-436-3722) with the unit model and serial number for any missing carton contents.
4. Record model, serial number, and date of purchase on front cover of this manual.

Assembly



WARNING

Consult Manual. Read and understand manual completely before using product. Failure to completely understand manual and product could result in death or serious injury. (000100a)

Call Generac Customer Service at 1-888-GENERAC (1-888-436-3722) for any assembly issues or concerns. Please have model and serial number available.

1. See [Figure 2-1](#). Place handle (A) onto handle supports (B). Push in latch buttons (C) and allow handle to slide into position. Button will lock handle into place.

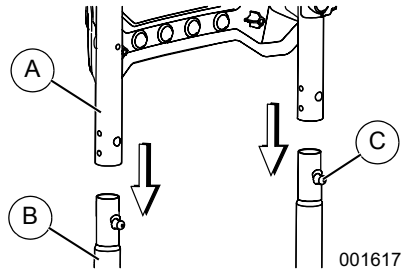

Figure 2-1. Insert Handle

NOTE: It may be necessary to move the handle supports from side to side in order to align the handle so it will slide over the handle supports.

2. See [Figure 2-2](#). Install hose hook.

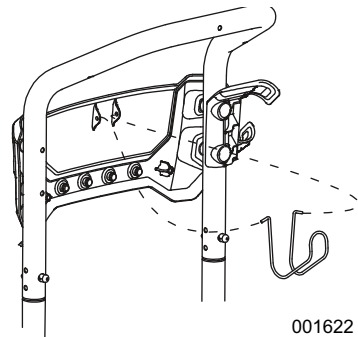

Figure 2-2. Install Hose Hook

- See [Figure 2-3](#). Install gun hook (A) on right (back) side of handle. Secure with tree clip (B).

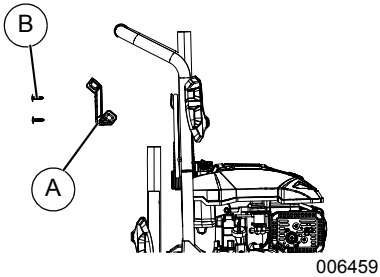

Figure 2-3. Install Gun Hook

- See [Figure 2-4](#). Insert and snap nozzles into spaces provided in handle.

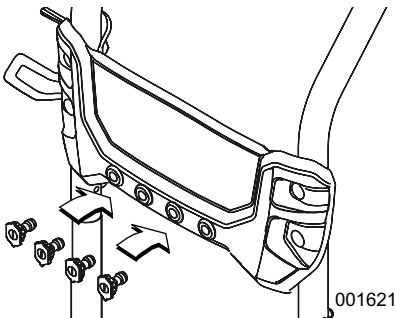

Figure 2-4. Insert Nozzles

- See [Figure 2-5](#) to install battery.

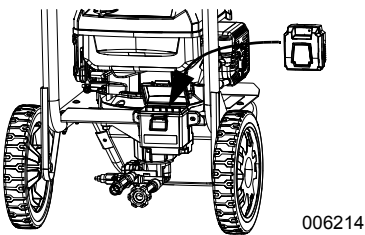

Figure 2-5. Install Battery

Add Engine Oil

Unit is shipped with no oil in the engine. Add engine oil before starting. See [Engine Oil Recommendations](#).

- Place power washer on a level surface.
- Verify oil fill area is clean.
- Remove oil fill cap and wipe dipstick clean.

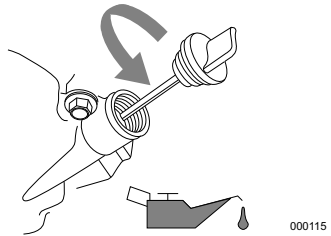

Figure 2-6. Remove Dipstick

- Add recommended engine oil.

NOTE: Some units have more than one oil fill location. It is only necessary to use one oil fill point.

- Thread dipstick into oil filler neck. Oil level is checked with dipstick fully inserted.
- See [Figure 2-7](#). Remove dipstick and verify oil level is within safe operating range.

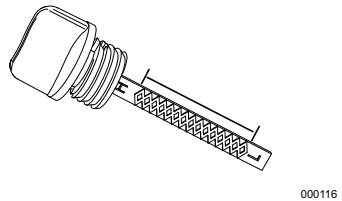

Figure 2-7. Safe Operating Range

- Install oil fill cap/dipstick and hand-tighten.

Fuel



▲ DANGER

Explosion and Fire. Fuel and vapors are extremely flammable and explosive. Add fuel in a well ventilated area. Keep fire and spark away. Failure to do so will result in death or serious injury. (000105)

Fuel requirements are as follows:

- Clean, fresh, unleaded gasoline.
 - Minimum rating of 87 octane/87 AKI (91 RON).
 - Up to 10% ethanol (gasohol) is acceptable.
 - DO NOT use E85.
 - DO NOT use a gas oil mix.
 - DO NOT modify engine to run on alternate fuels.
 - Add a fuel stabilizer prior to storing.
- Verify unit is OFF and cooled for a minimum of two minutes prior to fueling.
 - Place unit on level ground in a well ventilated area.
 - See [Figure 2-8](#). Clean area around fuel cap and remove cap slowly.

- Slowly add recommended fuel. Do not overfill.

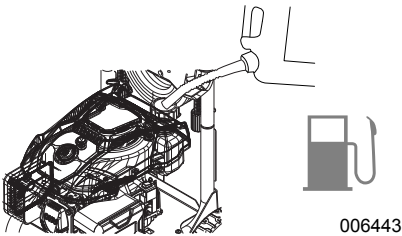

Figure 2-8. Add Recommended Fuel

- Install fuel cap.

NOTE: Allow spilled fuel to evaporate before starting unit.

Water Supply

NOTE: DO NOT run unit without sufficient water supply. Failure to follow water supply requirements will void unit warranty.

Water supply must meet the following requirements:

- DO NOT siphon standing water for the water supply.
- Water temperature must be less than 100°F (38°C).
- Water supply hose length must not exceed 50 ft (15.2 m).
- Water must be greater than 3.8 gallons per minute (17.3 liters per minute) and no less than 30 psi (206.8 kPa).
- DO NOT use a one-way valve, vacuum breaker, or check valve in any part of the water supply.

Connect Water Supply

- Remove and discard shipping cap from the pump water inlet.
- Run water supply for 30 seconds prior to connection to eliminate debris.
- See [Figure 2-9](#). Inspect inlet screen for debris. Clean screen or replace as necessary. DO NOT run power washer if inlet screen is damaged or missing.

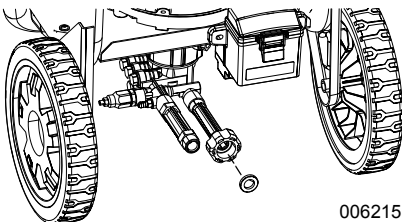

Figure 2-9. Inspect Inlet Screen

- See [Figure 2-10](#). Connect water supply hose to pump water inlet and hand-tighten.

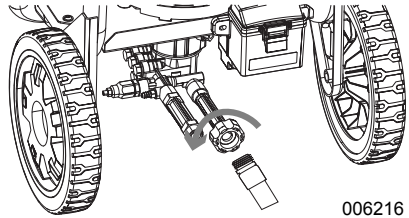

Figure 2-10. Connect Water Supply Hose

Connect High-Pressure Hose and Lance

- See [Figure 2-11](#). Connect lance to spray gun and hand-tighten.

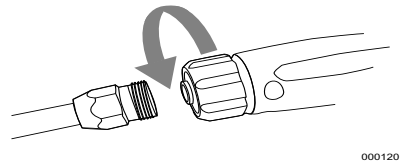

Figure 2-11. Connect Lance

- Place spray gun and nozzle extension into spray gun holder.
- See [Figure 2-12](#). Connect high-pressure hose to pump and hand-tighten.

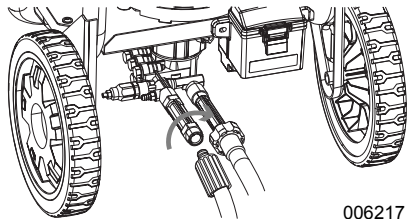
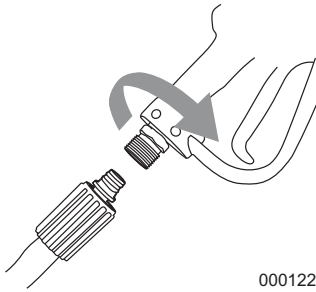

Figure 2-12. Connect High-Pressure Hose to Pump

- See [Figure 2-13](#). Connect high-pressure hose to base of spray gun and hand-tighten.



000122

Figure 2-13. Connect High-Pressure Hose to Spray Gun

Spray Gun

Become familiar with spray gun trigger and locking system prior to use.

1. See **Figure 2-14**. With unit OFF, hold spray gun and squeeze trigger to learn how trigger mechanism and locking system can be activated and deactivated.

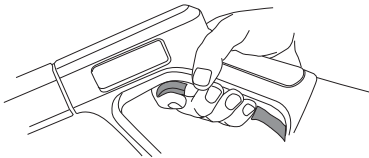

000123

Figure 2-14. Spray Gun (typical)

2. Turn ON the water, and squeeze the trigger to purge the pump system of air.
3. Verify spray gun is OFF with lock engaged before starting power washer.

Nozzles

1. Select correct nozzle for task.
2. See **Figure 2-15**. Pull back quick-connect collar and install nozzle.
3. Release quick-connect collar to secure nozzle.
4. Verify nozzle is locked in place.

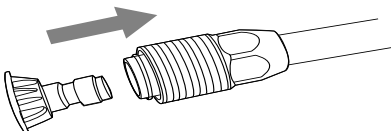

000125

Figure 2-15. Insert Nozzle

Blast Pressure Nozzle (Red)

MAXIMUM - Higher pressure and lower flow for stubborn or hard to reach surface such as second story surfaces, paint removal, oil stains, rust removal or other stubborn substances (tar, gum, grease, wax, etc.).



001396

Clean Pressure Nozzle (Green)

GENERAL - Medium pressure and medium flow for most all purpose cleaning such as home siding, brick patios, wood decks, driveways and sidewalks, garage floors, etc.

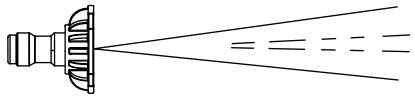

001398

Wash Pressure Nozzle (White)

DELICATE - Lower pressure and higher flow for gentle cleaning of cars/trucks, boats, RV's, patio furniture, lawn equipment, etc.

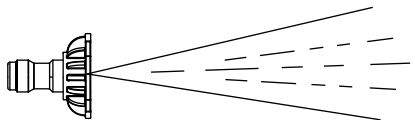

001399

Detergent Nozzle (Black)

DETERGENT ONLY (BLACK), Only use power washer safe detergents/soaps to help break down stubborn dirt and grime on a variety of surfaces.

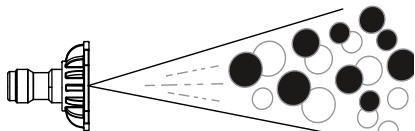

001400

Section 3 Operation

Operation and Use Questions

Call Generac Customer Service at 1-888-GENERAC (1-888-436-3722) with questions or concerns about unit operation and maintenance.

Before Starting Engine

Unit is shipped with no oil in the crankcase. Add engine oil before starting. See [Engine Oil Recommendations](#).

1. Verify engine oil level is correct.
2. Verify fresh fuel level is correct.
3. Verify all fittings and couplers are properly secured.
4. Verify sufficient water supply is properly connected.
5. Verify thermal relief valve is rotated and open to ground.
6. Verify unit is secure on level ground, with proper clearance and is in a well ventilated area.

NOTE: The Lithium-ion battery comes partially charged from the factory. Some batteries may not have enough energy to start the engine initially. Charge the battery fully before the initial use. To charge the battery, see [Maintaining the Battery](#).

NOTE: The engine has a special feature that does not require manually adjusting the choke.

Prepare Power Washer for Use

1. Place unit on level ground, within the specified clearance required.
2. Connect appropriate water supply.

Power Washer Placement for Use



⚠ DANGER

Asphyxiation. Running engines produce carbon monoxide, a colorless, odorless, poisonous gas. Carbon monoxide, if not avoided, will result in death or serious injury. (000103)



⚠ WARNING

Risk of Fire. Hot surfaces could ignite combustibles, resulting in fire. Fire could result in death or serious injury. (000110)



⚠ WARNING

Hot Surfaces. When operating machine, do not touch hot surfaces. Keep machine away from combustibles during use. Hot surfaces could result in severe burns or fire. (000108)

It is a violation of California Public Resource Code, Section 4442, to use or operate the engine on any forest-covered, brush-covered, or grass-covered land unless the exhaust system is equipped with a spark arrestor, as defined in Section 4442, maintained in effective working order. Other states or federal jurisdictions may have similar laws.

Only operate power washer outdoors in a well ventilated area. Never operate power washer indoors, or in a confined space. Be aware of building openings and ventilation systems where exhaust may enter during use.

- Verify power washer is placed on level ground to avoid tipping during operation.
- Only use the unit outdoors. Verify exhaust gas does not enter a confined area through windows, doors, ventilation intakes.
- See [Figure 3-1](#) Keep at least 5 ft (1.5 m) of clearance on all sides of power washer including overhead from dwellings and combustibles, when in use.

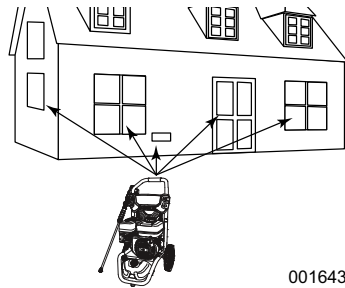

001643

Figure 3-1. Five Feet of Minimum Clearance

Transporting/Tipping of the Unit

Do not operate, store or transport the unit at an angle greater than 15 degrees.

⚠ WARNING

Personal Injury / Equipment Damage. Place wand in holster and verify that handle is locked into place before moving. Failure to do so could result in death, serious injury, or equipment damage. (000244)

Electric Start

NOTE: The battery must be installed before Electric Start operation. For initial battery installation, see [Assembly](#).

This power washer is equipped with both electric start and recoil start capabilities. Avoid prolonged cranking as it can damage the engine. To extend the life of the starter, use short starting cycles (no longer than 5 seconds). Wait 30 seconds between starting cycles.

If the engine will not crank, the battery temperature may be too hot. Remove the battery and allow to cool before attempting to start.

Power Washer Start-Up



WARNING

Vision Loss. Eye goggles are required to be worn when using this machine. Failure to wear eye goggles could result in permanent vision loss.

(000101)

NOTE: DO NOT run power washer without a sufficient water supply turned ON. Damage to equipment resulting from failure to follow this instruction will void warranty.

Electric Start

1. Connect a sufficient water supply.
2. Push and hold the Start/Stop button for 3 seconds or until button illuminates to energize starter system. See [Figure 3-2](#).

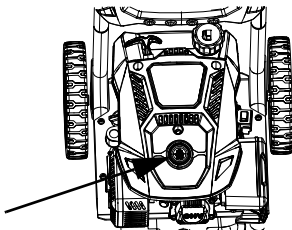

006220

Figure 3-2. Push Start/Stop Button

3. Hold trigger on spray gun while pushing the Start/Stop button for 1 second to start engine.
4. Release trigger on spray gun once engine starts.

NOTE: For Electric Start, the battery may require charging for the power washer to start. See [Maintaining the Battery](#). If the start button fails to start the engine, the power washer can be started with the recoil start.

Recoil Start

1. Connect a sufficient water supply.
2. Relieve spray gun pressure.
3. Place foot on unit to secure unit from movement when pulling recoil.
4. Hold trigger on spray gun while firmly grasping the recoil handle. Pull slowly until resistance is felt. Then pull rapidly to start engine. See [Figure 3-3](#).
5. Return recoil handle slowly. DO NOT let recoil snap back against recoil housing.



WARNING

Recoil Hazard. Recoil could retract unexpectedly if water pressure is not properly relieved from pump, creating kickback. Kickback could result in death or serious injury.

(000113)



WARNING

Personal injury. Risk of fluid injection. Do not aim spray gun at people, animals, electrical devices, or fragile items. Keep out of reach of children. Failure to do so could cause death or serious injury.

(000117c)

After engine-start attempt, if engine fails to run, point spray gun in safe direction, and squeeze spray gun trigger to release high pressure. Repeat steps 3 through 5.

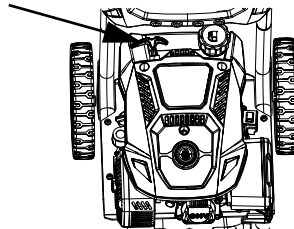

006220

Figure 3-3. Engine Recoil



WARNING

Fluid Injection. This machine produces high-pressure fluid streams that can pierce skin. Fluid injection could result in death or serious injury.

(000106b)



WARNING

Risk of Fire. Hot surfaces could ignite combustibles, resulting in fire. Fire could result in death or serious injury.

(000110)



WARNING

Hot Surfaces. When operating machine, do not touch hot surfaces. Keep machine away from combustibles during use. Hot surfaces could result in severe burns or fire.

(000108)

Power Washer Shut Down



WARNING

Fluid Injection. This machine produces high-pressure fluid streams that can pierce skin. Fluid injection could result in death or serious injury. (000106b)

IMPORTANT: Spray gun traps high-pressure water, even when engine is stopped and water is disconnected. Always point spray gun in safe direction, and squeeze spray gun trigger to release high-pressure. Engage trigger lock when not in use.

1. Release spray gun trigger.
2. Push Start/Stop button for 1 second.
3. Turn water supply OFF.
4. Squeeze spray gun trigger and release high-pressure water.
5. Engage trigger lock.

NOTE: If Start/Stop button fails to shut down engine, press and hold the emergency stop switch on side of engine for 6 seconds or until the engine stops completely. See [Figure 3-4](#).

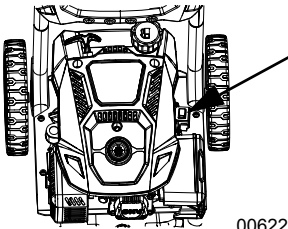

Figure 3-4. Emergency Stop Switch

Apply Detergent



WARNING

Fluid Injection. This machine produces high-pressure fluid streams that can pierce skin. Fluid injection could result in death or serious injury. (000106b)



WARNING

Personal injury. Risk of fluid injection. Do not aim spray gun at people, animals, electrical devices, or fragile items. Keep out of reach of children. Failure to do so could cause death or serious injury. (000117c)

NOTE: DO NOT use caustic liquid with power washer. Use ONLY power washer safe detergents. Follow all manufacturer's instructions on the detergent label.

Apply detergent as follows:

1. Verify black detergent nozzle is installed.
2. Open detergent tank cap.
3. Prepare detergent solution as required by job.

NOTE: Verify siphoning tube and filter remain fully submerged in detergent while in use.

NOTE: Detergent cannot be applied with high-pressure nozzle (White, Green or Red). Only use black nozzle with detergent.

4. Start engine.
5. Apply detergent to a dry surface. Start at lower portion of area to be washed and work upward using long, even, overlapping strokes.

IMPORTANT: Flush the detergent siphoning system after each use. Contact an authorized dealer or qualified service center with questions.

Rinsing



WARNING

Risk of Falling. Use of machine creates wet areas and trip hazards. Be aware of work area conditions. A fall could result in death or serious injury. (000112)



WARNING

Risk of Falling. Do not use this machine or any components on elevated surfaces. Doing so can result in a fall, serious injury, or death. (000114)

1. Remove black detergent nozzle from lance.
2. Select and install desired high-pressure nozzle.
3. Point spray gun in safe direction and squeeze trigger to flush remaining detergent from system.
4. Keep spray gun a safe distance from area you plan to spray.
5. Spray gun may kick back when using high pressure spray. To avoid injury, firmly grasp spray gun with both hands.
6. Apply a high-pressure spray to a small area and then inspect surface for damage. If no damage is found, continue rinsing.
7. Start at top of area to be rinsed, working down with same overlapping strokes as used for cleaning.

Clean Detergent Siphoning Tube

Flush detergent siphoning tube after each use before stopping the engine.

1. Place detergent siphoning tube/filter in bucket of clean water.
2. Remove high-pressure nozzle from lance.
3. Select and install black detergent nozzle.
4. Flush for 1-2 minutes.
5. Shut engine OFF.
6. Point spray gun in a safe direction, squeeze spray gun trigger to release retained high water pressure. Engage trigger lock.

After Each Use

DO NOT allow water to remain in unit for long periods of time. Sediments or minerals can deposit on pump parts and freeze pump. Follow these procedures after every use:

1. Shut engine OFF.
2. Turn water supply OFF.
3. Point spray gun in a safe direction, and squeeze trigger to relieve trapped pressure.
4. Let engine cool.
5. Disconnect hoses from spray gun and high-pressure outlet on pump. Drain water from hoses, spray gun, and lance. Use a rag to wipe off components.
6. Pull recoil handle approximately six times to remove remaining liquid from pump.
7. Store unit in a clean, dry area.

NOTE: If storing for more than 30 days, see [Storage](#).

Automatic Cool Down System (Thermal Relief)

When power washer runs for 3-5 minutes without spray gun activation, circulating water in pump can reach a temperature sufficient to engage the thermal relief system. The pump is cooled by discharging water onto ground.

Section 4 Maintenance and Troubleshooting

Maintenance

Regular maintenance will improve performance and extend engine/equipment life. Generac Power Systems, Inc. recommends that all maintenance work be performed by an Independent Authorized Service Dealer (IASD). Regular maintenance, replacement, or repair of the emissions control devices and systems may be performed by any repair shop or person of the owner's choosing. To obtain emissions control warranty service free of charge, the work must be performed by an IASD. See the emissions warranty.

Power washer warranty does not cover items subjected to operator abuse or negligence. To receive full warranty value, operator must maintain power washer as instructed in this manual, including proper storage as detailed in [Storage](#).

NOTE: Call 1-888-GENERAC (1-888-436-3722) with questions about component replacement.

NOTE: All required service and adjustments should be each season, as detailed in [Maintenance Schedule](#).

Maintenance Schedule

Follow maintenance schedule intervals, whichever occurs first according to use.

NOTE: Adverse conditions will require more frequent service.

First 5 Hours
Change engine oil
Every 8 Hours or Daily
Inspect/clean water inlet screen*
Inspect high-pressure hose
Inspect detergent siphoning hose/filter
Inspect spray gun and assembly for leaks
Clean debris
Inspect engine oil level
Every 20 Hours or Every Season
Change engine oil**
Every 50 Hours or Every Season
Inspect/clean air cleaner filter**
Inspect muffler and spark arrestor*
Every 100 Hours or Every Season
Service spark plug
Replace fuel filter

* Clean if clogged. Replace if perforated or torn.

** Service more often under dirty or dusty conditions.

Pump Oil

DO NOT attempt any oil maintenance on pump. Pump is lubricated and sealed at factory. No additional maintenance is required for life of pump.

Preventive Maintenance

Dirt or debris can cause improper operation and equipment damage. Clean power washer daily or before each use. Keep area around and behind muffler free from combustible debris. Inspect all cooling air openings on power washer.

- Use a damp cloth to wipe exterior surfaces clean.
- DO NOT insert any objects through cooling air openings.
- Use a soft bristle brush to loosen caked on dirt, oil, etc.
- Use a vacuum to pick up loose dirt and debris.

Inspect and Clean Inlet Screen

Inspect inlet screen on pump water inlet. Clean clogged screen and replace screen if damaged.

Inspect High-Pressure Hoses

High-pressure hoses can develop leaks from wear, kinking, or abuse. Inspect hoses before each use. Inspect for cuts, leaks, abrasions, bulging, and damage or movement of couplings. If these conditions exist, replace hose immediately.

NOTE: DO NOT repair high-pressure hose. Replace with hose that meets or exceeds maximum pressure rating of unit.

Inspect Detergent Siphoning Tube

Inspect filter on detergent tube and clean if clogged. Tube should fit tightly on barbed fitting. Examine tube for leaks or tears. Replace filter or tube if either is damaged.

Inspect Spray Gun

NOTE: Replace spray gun immediately if it fails any test steps.

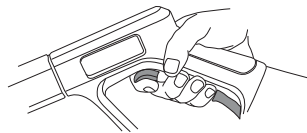

000123

Figure 4-1. Test Spray Gun (typical)

1. Verify spray gun hose connection is secure.
2. Squeeze and release trigger.

NOTE: Trigger should spring back into place and lock when released.

Nozzle Maintenance

A pulsing sensation felt when squeezing spray gun trigger may be caused by excessive pump pressure. Typical causes of excessive pump pressure are nozzle clog or restriction. Immediately clean nozzle as follows:



WARNING

Fluid Injection. This machine produces high-pressure fluid streams that can pierce skin. Fluid injection could result in death or serious injury. (000106b)

1. Turn engine and water supply OFF.
- NOTE:** Keep high-pressure hose connected to pump and spray gun while system is pressurized.
2. Relieve spray gun water pressure.
 3. Remove nozzle from lance.
 4. See [Figure 4-2](#). Use a paper clip to remove debris.
 5. See [Figure 4-3](#). Remove lance from spray gun and back flush thoroughly.
 6. Install nozzle on lance.
 7. Install lance on spray gun.

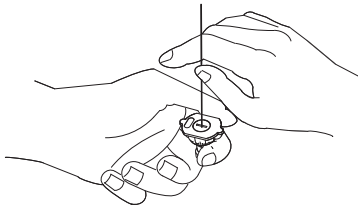

000109

Figure 4-2. Remove Debris

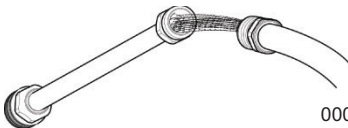

000131

Figure 4-3. Back Flush Lance

8. Verify hose is connected to pump water inlet, and high-pressure hose is connected to spray gun and pump.
9. Turn water ON.
10. Start engine.
11. Test power washer by operating with each quick connect nozzle.

Engine Maintenance

Engine Oil Recommendations

To maintain the product warranty, the engine oil should be serviced in accordance with the recommendations of this manual. For your convenience, maintenance kits designed and intended for use on this product are available from the manufacturer that include engine oil, oil filter, air filter, spark plug(s), a shop towel and funnel. These kits can be obtained from an Independent Authorized Service Dealer (IASD).

Climate determines proper engine oil viscosity. See chart to select correct viscosity.

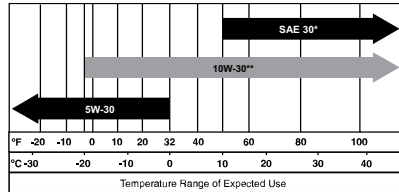

000130

Figure 4-4. Oil Viscosity

- * Below 50°F (10°C) use of SAE 30 will result in hard start.
- ** Above 80°F (27°C) use of 10W30 may cause increased oil consumption. Inspect oil level more frequently.

Inspect Engine Oil Level

Inspect engine oil level prior to each use, or every 8 hours of operation.

1. Place power washer on a level surface.
2. Clean area around oil fill.
3. See [Figure 4-5](#). Remove oil fill cap and wipe dipstick clean.

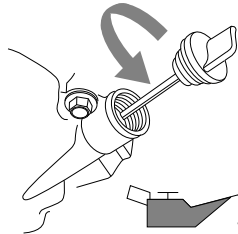

000115

Figure 4-5. Engine Oil Fill

4. See [Figure 4-6](#). Screw dipstick into filler neck. Verify proper oil level on dipstick.

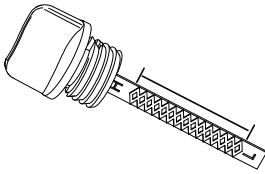

000116

Figure 4-6. Safe Operating Range

5. Add recommended engine oil as necessary.
6. Replace oil fill cap and hand-tighten.

NOTE: Some units have more than one oil fill location. It is only necessary to use one oil fill point.

Change Engine Oil

When using power washer under extreme, dirty, dusty conditions, or in extremely hot weather, change oil more frequently.

NOTE: Don't pollute. Conserve resources. Return used oil to collection centers.

Change oil while engine is still warm from running, as follows:

1. Place power washer on a level surface.
2. Disconnect the spark plug wire from the spark plug and place the wire where it cannot contact spark plug.
3. Clean area around oil fill, and oil drain plug.
4. Remove oil fill cap.
5. See [Figure 4-7](#). Remove oil drain plug (A) and drain oil completely into a suitable container.
6. Install oil drain plug and tighten securely.
7. See [Figure 4-6](#). Slowly pour oil into oil fill opening until oil level is between L and H marks on dipstick. **DO NOT** overfill.
8. Install oil fill cap, and finger tighten.
9. Wipe up any spilled oil.
10. Properly dispose of oil in accordance with all applicable regulations.

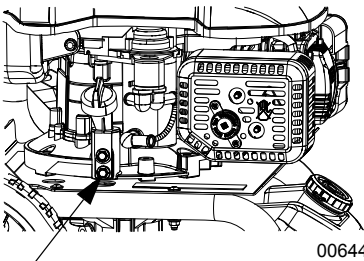

006444

Figure 4-7. Oil Drain Plug

Air Filter

Engine will not run properly and may be damaged if run with a dirty air cleaner. Service air cleaner more frequently in dirty or dusty conditions.

To service air cleaner:

1. Remove air cleaner cover.
2. Remove filter element(s).
3. Inspect filter element(s) and replace if damaged. To order replacements, contact Generac Customer Service at 1-888-GENERAC (888-436-3722) for the name of your nearest IASD.
4. Clean foam filter element in warm soapy water. Rinse, and allow to dry thoroughly. Dip in clean engine oil and squeeze out excess oil.
5. Tap paper filter element several times on hard surface to remove dirt. Compressed air (not exceeding 30 psi (207 kPa)) can also be used to blow through filter element from the inside.
6. Use a clean, damp cloth to wipe dirt from inside air cleaner cover.
7. Put cleaned or new filter element(s) in place. Verify gasket is in place (if equipped).
8. Install air cleaner cover. Tighten air cleaner screws or fasteners securely.

Service Spark Plug

To service spark plug:

1. Clean area around spark plug.
2. Remove and inspect spark plug.
3. See [Figure 4-8](#). Inspect electrode gap with wire feeler gauge and replace spark plug if gap (A) is not within specification listed on Product Specifications Sheet.

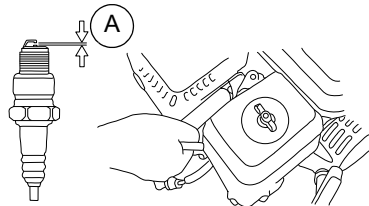

000134a

Figure 4-8. Spark Plug

NOTE: Replace spark plug if electrodes are pitted, burned or porcelain is cracked. Use **ONLY** recommended replacement plug. See Product Specifications Sheet.

4. Install spark plug finger tight, and tighten an additional $\frac{3}{8}$ to $\frac{1}{2}$ turn using spark plug wrench.

Inspect Engine Spark

WARNING

Accidental Start-up. Disconnect spark plug wire when working on unit. Failure to do so could result in death or serious injury.

(000102)

1. Disconnect spark plug wire from spark plug.
2. Secure spark plug wire where it cannot contact spark plug.
3. Test spark plug with approved spark plug tester.

NOTE: DO NOT inspect for spark with spark plug removed.

Inspect Muffler And Spark Arrestor

NOTE: It is a violation of California Public Resource Code, Section 4442, to use or operate the engine on any forest-covered, brush-covered, or grass-covered land unless the exhaust system is equipped with a spark arrestor, as defined in Section 4442, maintained in effective working order. Other states or federal jurisdictions may have similar laws.

NOTE: Call 1-888-GENERAC (1-888-436-3722) with questions about component replacement.

NOTE: Use ONLY original equipment replacement parts.

Inspect muffler for cracks, corrosion, or other damage. Remove spark arrestor, if equipped, inspect for damage or carbon blockage. If replacement parts are required.

Inspect Spark Arrestor Screen (if equipped)



WARNING

Hot Surfaces. When operating machine, do not touch hot surfaces. Keep machine away from combustibles during use. Hot surfaces could result in severe burns or fire.

(000108)

4. See [Figure 4-9](#). Loosen fasteners and remove spark arrestor from muffler.
5. Inspect spark arrestor. Replace if torn, perforated or otherwise damaged.
 - Spark Arrestor P/N 10000018388
6. If screen is not damaged, clean it with a commercial solvent and replace.

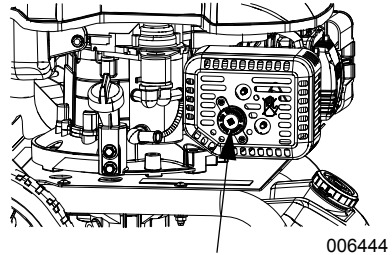

Figure 4-9. Spark Arrestor Fasteners

Maintaining the Battery

Check the charge of the battery by pressing the Battery Powerbar™ button. A minimum of 2 illuminated LED lights are required to start the engine. See [Figure 4-10](#).

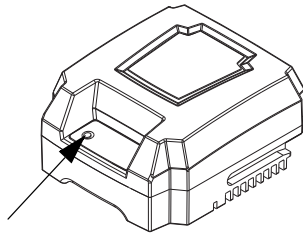

Figure 4-10. Battery Powerbar™ Button

Charge the Battery

NOTE: The 12V Lithium-ion battery provided should be used only with the battery charger supplied with the power washer (P/N: 10000020284).

1. Remove battery from box. See [Figure 4-11](#).

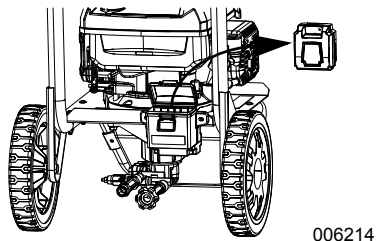

Figure 4-11. Remove Battery

2. Plug battery charger into a 120V, 60Hz, AC receptacle only. The green “READY” LED on the charger will illuminate.
3. Slide battery into charger bay. The red “CHARGING” LED will illuminate to indicate charging.

- When battery is fully charged, the green "READY" LED will illuminate. Remove battery from charger.

NOTE: A completely discharged battery will fully charge in approximately 1.5 hours. The battery will stay fully charged if left on the charger with no damage to the battery. The battery needs to be replaced if the green "READY" LED does not illuminate after 3 hours of charging. See [Replace the Battery](#).

- Return battery to box and close the lid for use.
- Unplug battery charger from receptacle when not in use.

Replace the Battery

Contact your nearest Independent Authorized Service Dealer (IASD), or contact Generac Customer Service at 1-888-GENERAC (1-888-436-3722), for battery replacement.



⚠️ WARNING

Explosion. Do not dispose of batteries in a fire. Batteries are explosive. Electrolyte solution can cause burns and blindness. If electrolyte contacts skin or eyes, flush with water and seek immediate medical attention.

(000162)



⚠️ WARNING

Risk of burn. Do not open or mutilate batteries. Batteries contain electrolyte solution which can cause burns and blindness. If electrolyte contacts skin or eyes, flush with water and seek immediate medical attention.

(000163a)

⚠️ WARNING

Environmental Hazard. Always recycle batteries at an official recycling center in accordance with all local laws and regulations. Failure to do so could result in environmental damage, death or serious injury.

(000228)

Storage

General



⚠️ DANGER

Explosion and Fire. Fuel and vapors are extremely flammable and explosive. Add fuel in a well ventilated area. Keep fire and spark away. Failure to do so will result in death or serious injury.

(000105)



⚠️ WARNING

Risk of Fire. Verify machine has properly cooled before installing cover and storing machine. Hot surfaces could result in fire.

(000109)

- DO NOT place a storage cover on a hot power washer. Allow unit to cool to room temperature before storage.
- DO NOT store fuel from one season to another unless properly treated.

- Replace fuel container if rust is present. Rust in fuel will cause fuel system problems.
- Cover unit with a suitable protective, moisture resistant cover.
- Store unit in a clean and dry area.
- Always store power washers and fuel away from heat and ignition sources.

Prepare Fuel System for Storage

Fuel stored over 30 days can go bad and damage fuel system components. Keep fuel fresh, use fuel stabilizer.

If fuel stabilizer is added to fuel system, prepare and run engine according to [Power Washer Start-Up](#). Run engine for 2 minutes to circulate stabilizer throughout fuel system. Adequately prepared fuel can be stored up to 24 months.

NOTE: If fuel has not been treated with fuel stabilizer, it must be drained into an approved container. Run engine until it stops from lack of fuel. Use of fuel stabilizer in fuel storage container is recommended to keep fuel fresh.

Prepare Engine for Storage

- Change engine oil.
- Remove spark plug.
- Pour a tablespoon (5-10cc) of clean engine oil or spray a suitable fogging agent into cylinder.
- Pull starter recoil several times to distribute oil in cylinder.
- Install spark plug.
- Pull recoil slowly until resistance is felt. This will close valves so moisture cannot enter engine cylinder. Gently release recoil.

Change Oil

Change engine oil before storage. See [Change Engine Oil](#).

Prepare Pump for Storage

NOTE: If not using power washer for more than 30 days, prepare engine and pump for storage.

Protect unit from freezing temperatures. Failure to do so will permanently damage pump and render unit inoperable. Freeze damage is not covered under warranty.

Protect unit from freezing temperatures as follows:

- Shut engine OFF.
- Turn fuel valve to OFF.
- Turn water supply OFF.
- Point spray gun in a safe direction, and squeeze trigger to relieve trapped pressure.
- Let engine cool.

6. Disconnect hoses from spray gun and high-pressure outlet on pump. Drain water from hoses, spray gun, and lance. Use a rag to wipe off components.
7. Empty pump of all remaining liquids.
8. Pull recoil handle approximately six times to remove remaining liquid from pump.
9. Winterize pump with Generac Pump Shield™ (P/N 0L2414). This minimizes freeze damage and lubricates pistons and seals.

NOTE: If Generac Pump Shield™ is not available, connect a 3 ft (1 m) section of garden hose to water inlet adapter. Pour RV-antifreeze (alcohol free antifreeze) into hose. Pull recoil handle twice. Disconnect hose.

Store unit in a clean and dry area.

Prepare Battery and Charger for Storage

When not in use, disconnect battery charger and store in a cool, dry area. Wet, damp areas cause corrosion of terminals and electrical contacts. If stored for long periods in high temperatures (110°F), permanent damage to the battery can result. Check electrical terminals and contacts on the battery and charger. Wipe with clean, dry cloth or blow clean with compressed air.

After storage, check the charge of the battery by pressing the Battery Powerbar™ button. A minimum of 2 illuminated LED lights are required to start the engine. See [Maintaining the Battery](#).

Table 4-1. Troubleshooting

Problem	Cause	Correction
Pump fails to produce pressure, has erratic pressure, chattering, loss of pressure, low water volume.	<ol style="list-style-type: none"> 1. Low pressure nozzle installed. 2. Water inlet is obstructed. 3. Inadequate water supply. 4. Inlet hose kinked or leaking. 5. Clogged hose inlet screen. 6. Water supply is over 100°F (37.8°C). 7. High-pressure hose is obstructed, or leaks. 8. Spray gun leaks. 9. Nozzle is obstructed. 10. Pump is faulty. 11. Dirty fuel filter. 	<ol style="list-style-type: none"> 1. Replace with high-pressure nozzle. 2. Clean inlet. 3. Provide adequate water flow. 4. Straighten inlet hose, patch leak. 5. Inspect and clean inlet hose screen. 6. Provide cooler water supply. 7. Clear obstructions or replace hose. 8. Replace spray gun. 9. Clean nozzle. 10. Contact IASD. 11. Replace fuel filter.
Detergent fails to mix with spray.	<ol style="list-style-type: none"> 1. Detergent siphoning tube is not submerged. 2. Detergent siphoning tube/ filter is obstructed or cracked. 3. High-pressure nozzle installed. 	<ol style="list-style-type: none"> 1. Insert detergent siphoning tube into detergent. 2. Clean or replace filter/ detergent siphoning tube. 3. Install low-pressure nozzle.
Engine runs well at no-load, but bogs down when load is applied.	<ol style="list-style-type: none"> 1. Engine speed too low. 2. Dirty fuel filter. 	<ol style="list-style-type: none"> 1. Contact IASD. 2. Replace fuel filter.
Engine will not start, or starts and runs rough.	<ol style="list-style-type: none"> 1. Dirty air filter. 2. Out of fuel 3. Stale fuel. 4. Spark plug wire not connected to plug. 5. Bad spark plug. 6. Water in fuel. 7. Excessively rich fuel mixture. 8. Dirty fuel filter. 	<ol style="list-style-type: none"> 1. Clean or replace air filter. 2. Fill fuel tank. 3. Replace with fresh fuel. 4. Connect wire to spark plug. 5. Replace spark plug. 6. Drain fuel tank, replace with fresh fuel. 7. Contact IASD. 8. Replace fuel filter.
Engine shuts down during operation.	<ol style="list-style-type: none"> 1. Out of fuel. 	<ol style="list-style-type: none"> 1. Fill fuel tank.
Engine lacks power.	<ol style="list-style-type: none"> 1. Dirty air filter. 	<ol style="list-style-type: none"> 1. Replace air filter.
Engine will not electric start.	<ol style="list-style-type: none"> 1. Battery has low power. 2. Battery is too hot. 3. Gun not triggered. 4. Debris in battery box. 	<ol style="list-style-type: none"> 1. Charge or replace battery. 2. Allow battery to cool. 3. Trigger gun while starting. 4. Remove debris.

Part No. 10000025895 Rev. A 01/30/2018
©2018 Generac Power Systems, Inc.
All rights reserved
Specifications are subject to change without notice.
No reproduction allowed in any form without prior
written consent from Generac Power Systems, Inc.



Generac Power Systems, Inc.
S45 W29290 Hwy. 59
Waukesha, WI 53189
1-888-GENERAC (1-888-436-3722)
www.generac.com