

The Simpson logo is an oval with a sunburst pattern in the background and the word "SIMPSON" in bold, uppercase letters across the center.

**SIMPSON**

# OPERATOR'S MANUAL

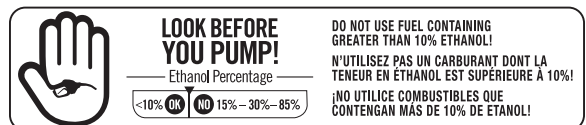

## Cold Water Pressure Washer Trailer

### **WARNING**

**READ AND FOLLOW ALL SAFETY RULES AND INSTRUCTIONS IN THIS MANUAL  
BEFORE ATTEMPTING TO OPERATE THIS MACHINE.  
FAILURE TO COMPLY WITH THESE INSTRUCTIONS MAY RESULT IN PERSONAL INJURY.**

**NOTE:** This Operator's Manual covers several models. Features may vary by model. Not all features in this manual are applicable to all models and the model depicted may differ from yours.

---

**FNA GROUP, INC. PLEASANT PRAIRIE, WI 53158**

---

## Thank You

### Table of Contents

<i>Safe Operation Practices</i> .....	3	<i>Maintenance</i> .....	13
<i>Assembly &amp; Setup</i> .....	8	<i>Troubleshooting</i> .....	15
<i>Controls &amp; Features</i> .....	9		
<i>Operation</i> .....	10		

### Record Product Information

Before setting up and operating your new equipment, please locate the model plate on the equipment and record the information in the provided area to the right. You can locate the model plate on the surface of the frame, in front of the engine. This information will be necessary, should you seek technical support via our web site, Customer Support Department, or with a local authorized service dealer.

#### MODEL NUMBER

--	--	--	--	--	--	--	--	--	--	--	--	--	--	--	--	--	--	--	--	--

#### SERIAL NUMBER

--	--	--	--	--	--	--	--	--	--	--	--	--	--	--	--	--	--	--	--	--

#### VIN NUMBER

--	--	--	--	--	--	--	--	--	--	--	--	--	--	--	--	--	--	--	--	--

### Customer Support

*For machines needing service or parts replacement please contact our Customer Service Department at 1-877-362-4271*

# Important Safe Operation Practices

This manual contains information that is important for you to know and understand. This information relates to protecting YOUR SAFETY and PREVENTING EQUIPMENT PROBLEMS. To help you recognize this information, we use the symbols below. Please read the manual and pay attention to these symbols.



**DANGER:** Indicates an imminently hazardous situation which, if not avoided, **will** result in **death or serious injury**.



**WARNING:** Indicates a potentially hazardous situation which, if not avoided, **could** result in **death or serious injury**.



**CAUTION:** Indicates a potentially hazardous situation which, if not avoided, **may** result in **minor or moderate injury**.

**NOTICE:** Indicates a practice **not related to personal injury** which, if not avoided, **may** result in **property damage**.

## CALIFORNIA PROPOSITION 65



**WARNING:** This product and its exhaust contain chemicals known to the State of California to cause cancer, birth defects or other reproductive harm. In addition, some cleaning products and dust contain chemicals known to the State of California to cause cancer, birth defects or other reproductive harm. **Wash hands after handling.**



**DANGER:** This machine was built to be operated according to the safe operation practices in this manual. As with any type of power equipment, carelessness or error on the part of the operator can result in serious injury. This machine is capable of penetrating skin before amputating fingers etc., hands, toes and feet and throwing objects. Failure to observe the following safety instructions could result in serious injury or death.

**IMPORTANT!** If you loan, rent, or sell this machine, be sure to include all instructional materials with the unit.



**DANGER:** Carbon Monoxide. Using an engine indoors can kill you in minutes. Engine/burner exhaust contains high levels of carbon monoxide (CO), a poisonous gas you cannot see or smell. You may be breathing CO even if you do not smell engine exhaust.

- **NEVER** use an engine or oil burner inside homes, garages, crawlspaces or other partly enclosed areas. Deadly levels of carbon monoxide can build up in these areas. Using a fan or opening windows and doors does **NOT** supply enough fresh air.

- **ONLY** use outdoors and far away from open windows, doors and vents. These openings can pull in engine exhaust. Never operate the pressure washer in or near a location occupied by humans or animals.
- Even when the engine is used correctly, CO may leak into your home. **ALWAYS** use a battery-powered or battery backup CO alarm in your house. **Read and follow all directions for CO alarm before using.** If you feel sick, dizzy or weak at anytime, move to fresh air immediately. See a doctor. You could have carbon monoxide poisoning.



**WARNING!** Do not operate this unit until you read this instruction manual and the engine instruction manual for safety, operation and maintenance instructions. **If you have any questions regarding this product, please contact our customer service department. Contact information can be located in the Table of Contents section of this manual.**



**DANGER! Risk of injection or severe injury. Keep clear of nozzle. Do not direct discharge stream at persons or live animals. This product is to be used only by trained operators.**

 <b>DANGER! RISK OF EXPLOSION OR FIRE</b>	
WHAT CAN HAPPEN	HOW TO PREVENT IT
<ul style="list-style-type: none"> <li>• Spilled gasoline (diesel, kerosene, approved alternate fuel) and it's vapors can become ignited from cigarette sparks, electrical arcing, exhaust gases and hot engine components such as the muffler.</li> </ul>	<ul style="list-style-type: none"> <li>• Shut off engine and allow it to cool before adding fuel to the tank.</li> <li>• During refueling all ignition sources and switches must be in the OFF position.</li> <li>• Use care in filling tank to avoid spilling fuel. Move pressure washer away from fueling area before starting engine.</li> </ul>
<ul style="list-style-type: none"> <li>• Heat will expand fuel in the tank which could result in spillage and possible fire explosion.</li> </ul>	<ul style="list-style-type: none"> <li>• Keep maximum fuel level 1/2" (12.7 mm) below bottom of filler neck to allow for expansion.</li> </ul>
<ul style="list-style-type: none"> <li>• Operating the pressure washer in an explosive environment could result in a fire.</li> </ul>	<ul style="list-style-type: none"> <li>• Operate and fuel equipment in well-ventilated areas free from obstructions. Equip areas with fire extinguisher suitable for gasoline fires.</li> </ul>
<ul style="list-style-type: none"> <li>• Materials placed against or near the pressure washer can interfere with its proper ventilation features causing overheating and possible ignition of the materials.</li> </ul>	<ul style="list-style-type: none"> <li>• Never operate pressure washer in an area containing dry brush or weeds.</li> </ul>

**DANGER! RISK OF EXPLOSION OR FIRE (continued)**

WHAT CAN HAPPEN	HOW TO PREVENT IT
<ul style="list-style-type: none"> <li>Improperly stored fuel could lead to accidental ignition. Fuel improperly secured could get into the hands of children or other unqualified persons.</li> </ul>	<ul style="list-style-type: none"> <li>Store engine and burner fuel in a clean OSHA approved container, in a secure location away from work area. Do not allow debris or moisture to enter container.</li> </ul>
<ul style="list-style-type: none"> <li>Spraying of gasoline, kerosene or any kind of flammable solvent with this product could result in serious injury or death.</li> </ul>	<ul style="list-style-type: none"> <li>Do not spray flammable liquids.</li> </ul>
<ul style="list-style-type: none"> <li>Flammable liquids can create fumes which can ignite, causing property damage or serious injury.</li> </ul>	<ul style="list-style-type: none"> <li>Do not operate near an open flame or an ignition source.</li> </ul>

**DANGER! RISK TO BREATHING (ASPHYXIATION)**

WHAT CAN HAPPEN	HOW TO PREVENT IT
<ul style="list-style-type: none"> <li>Breathing exhaust fumes will cause serious injury or death! Engine exhaust contains carbon monoxide, an odorless and deadly gas.</li> </ul>	<ul style="list-style-type: none"> <li>Operate pressure washer only in well-ventilated areas. Avoid enclosed areas such as garages, basements, etc.</li> <li>Never operate unit in or near a location occupied by humans or animals.</li> <li>Never connect pressure washer to a TYPE B gas vent.</li> </ul>
<ul style="list-style-type: none"> <li>Some cleaning fluids contain substances which could cause injury to skin, eyes or lungs.</li> </ul>	<ul style="list-style-type: none"> <li>Use only cleaning fluids specifically recommended for high pressure washers. Follow manufacturers recommendations. Do not use chlorine bleach or any other corrosive compound.</li> </ul>

**DANGER! RISK OF FLUID INJECTION AND LACERATION**



WHAT CAN HAPPEN	HOW TO PREVENT IT
<ul style="list-style-type: none"> <li>Your pressure washer operates at fluid pressures and velocities high enough to penetrate human and animal flesh which could result in amputation or other serious injury. Leaks caused by loose fittings or worn or damaged hoses can result in injection injuries. <b>DO NOT TREAT FLUID INJECTION AS A SIMPLE CUT!</b> See a physician immediately!</li> </ul>	<ul style="list-style-type: none"> <li>Inspect the high pressure hose regularly. Replace the hose immediately if it is damaged, worn, has melted from contacting the engine, or shows any signs of cracks, bubbles, pinholes, or other leakage. Never grasp a high pressure hose that is leaking or damaged.</li> <li>Never touch, grasp or attempt to cover a pinhole or similar water leak on the high pressure hose. The stream of water IS under high pressure and WILL penetrate skin.</li> <li>Never place hands in front of nozzle.</li> <li>Direct spray away from self and others.</li> <li>Make sure hose and fittings are tightened and in good condition. Never hold onto the hose or fittings during operation.</li> <li>Do not allow hose to contact muffler.</li> <li>Never attach or remove wand or hose fittings while system is pressurized.</li> <li>When using replacement lances or guns with this pressure washer, <b>DO NOT</b> use a lance and/or lance/gun combination that is shorter in length than what was provided with this pressure washer as measured from the nozzle end of the lance to the gun trigger.</li> <li>Use only accessories rated equal to or higher than the rating of the pressure washer.</li> </ul>
<ul style="list-style-type: none"> <li>Injuries can result if system pressure is not reduced before attempting maintenance or disassembly.</li> </ul>	<ul style="list-style-type: none"> <li>To relieve system pressure, shut off engine, turn off water supply and pull gun trigger until water stops flowing.</li> </ul>



 <b>DANGER! RISK OF INJURY FROM SPRAY</b>	
WHAT CAN HAPPEN	HOW TO PREVENT IT
<ul style="list-style-type: none"> <li>High-velocity fluid spray can cause objects to break, projecting particles at high speed.</li> </ul>	<ul style="list-style-type: none"> <li>Always wear safety glasses. Wear protective clothing to protect against accidental spraying.</li> <li>Never point wand at, or spray people or animals.</li> </ul>
<ul style="list-style-type: none"> <li>Light or unsecured objects can become hazardous projectiles.</li> </ul>	<ul style="list-style-type: none"> <li>Always secure trigger lock when wand is not in service to prevent accidental operation.</li> <li>Never permanently secure trigger in pull-back (open) position.</li> </ul>



 <b>DANGER! RISK OF UNSAFE OPERATION</b>	
WHAT CAN HAPPEN	HOW TO PREVENT IT
<ul style="list-style-type: none"> <li>Unsafe operation of your pressure washer could lead to serious injury or death to you or others.</li> </ul>	<ul style="list-style-type: none"> <li>Do not use chlorine bleach or any other corrosive compound.</li> <li>Become familiar with the operation and controls of the pressure washer.</li> <li>Keep operating area clear of all persons, pets and obstacles.</li> <li>Do not operate the product when fatigued or under the influence of alcohol or drugs. Stay alert at all times.</li> <li>Never compromise the safety features of this product.</li> <li>Do not operate machine with missing, broken or unauthorized parts.</li> <li>Never leave wand unattended while unit is running.</li> <li>Do not obstruct the burner exhaust. (If equipped)</li> <li>Do not tamper with the safety pressure relief valve.</li> <li>Do not tamper with the unloader valve.</li> <li>Do not modify the pressure washer.</li> </ul>
<ul style="list-style-type: none"> <li>If proper starting procedure is not followed, engine can kickback causing serious hand and arm injury.</li> </ul>	<ul style="list-style-type: none"> <li>If engine does not start after two pulls, squeeze trigger of gun to relieve pump pressure. Pull starter cord slowly until resistance is felt. Then pull cord rapidly to avoid kickback and prevent hand or arm injury.</li> </ul>
<ul style="list-style-type: none"> <li>The spray gun/wand is a powerful cleaning tool that could look like a toy to a child.</li> </ul>	<ul style="list-style-type: none"> <li>Keep children away from the pressure washer at all times.</li> </ul>
<ul style="list-style-type: none"> <li>Reactive force of spray will cause gun/wand to kickback, and could cause the operator to slip or fall or misdirect the spray. Improper control of gun/wand can result in injuries to self and others.</li> </ul>	<ul style="list-style-type: none"> <li>Do not stand on an unstable support or overreach.</li> <li>Do not use pressure washer while standing on a ladder.</li> <li>Grip gun/wand firmly with both hands. Expect the gun to kickback when triggered.</li> </ul>



 <b>DANGER! RISK OF INJURY OR PROPERTY DAMAGE WHEN TRANSPORTING OR STORING</b>	
WHAT CAN HAPPEN	HOW TO PREVENT IT
<ul style="list-style-type: none"> <li>Fuel or oil can leak or spill and could result in fire or breathing hazard. Serious injury or death can result. Fuel or oil leaks will damage carpet, paint or other surfaces in vehicles or trailers.</li> <li>Oil could fill the cylinder and damage the engine if the unit is not stored or transported in an upright position.</li> </ul>	<ul style="list-style-type: none"> <li>If pressure washer is equipped with a fuel shut-off valve, turn the valve to the OFF position before transporting to avoid fuel leaks. If pressure washer is not equipped with a fuel shut-off valve, drain the fuel from tank before transporting.</li> <li>Only transport fuel in an OSHA-approved container.</li> <li>Always place pressure washer on a protective mat when transporting to protect against damage to vehicle from leaks.</li> <li>Always transport and store unit in an upright position. Remove pressure washer from vehicle immediately upon arrival at your destination.</li> </ul>

 <b>DANGER! RISK OF ELECTRICAL SHOCK</b>	
WHAT CAN HAPPEN	HOW TO PREVENT IT
<ul style="list-style-type: none"> <li>Spray directed at electrical outlets or switches, or objects connected to an electrical circuit, could result in a fatal electrical shock.</li> </ul>	<ul style="list-style-type: none"> <li>Unplug any electrically operated product before attempting to clean it. Direct spray away from electric outlets and switches.</li> </ul>

  <b>DANGER! RISK OF CHEMICAL BURN</b>	
WHAT CAN HAPPEN	HOW TO PREVENT IT
<ul style="list-style-type: none"> <li>Use of acids, toxic or corrosive chemicals, poisons, insecticides or any kind of flammable solvent with this product could result in serious injury or death.</li> </ul>	<ul style="list-style-type: none"> <li>Do not spray acids, gasoline, kerosene, or any other flammable materials with this product. Use only household detergents, cleaners and degreasers recommended for use with pressure washers.</li> <li>Wear protective clothing, safety glasses to protect eyes and skin from contact with sprayed materials</li> </ul>

  <b>DANGER! RISK OF BURSTING</b>	
WHAT CAN HAPPEN	HOW TO PREVENT IT
<ul style="list-style-type: none"> <li>High-velocity fluid spray directed at pneumatic tire sidewalls (such as found on automobiles, trailers and the like) could damage the sidewall resulting in serious injury.</li> </ul>	<ul style="list-style-type: none"> <li>On pressure washers rated above 1600 psi (11032 kPa) use the widest fan spray (40° nozzle) and keep the spray a minimum of 8" (20 cm) from the pneumatic tire sidewall. Do not aim spray directly at the joint between the tire and rim.</li> </ul>

  <b>DANGER! RISK OF HOT SURFACES</b>	
WHAT CAN HAPPEN	HOW TO PREVENT IT
<ul style="list-style-type: none"> <li>Contact with hot surfaces, such as engine exhaust components, could result in serious burn.</li> </ul>	<ul style="list-style-type: none"> <li>During operation, touch only the control surfaces of the pressure washer. Keep children away from the pressure washer at all times. They may not be able to recognize the hazards of this product.</li> <li>DO NOT touch spray, ALWAYS direct spray away from self and others.</li> <li>Allow machine to cool before servicing or making any adjustments.</li> </ul>

  <b>WARNING! RISK OF INJURY FROM LIFTING</b>	
WHAT CAN HAPPEN	HOW TO PREVENT IT
<ul style="list-style-type: none"> <li>Serious injury can result from attempting to lift too heavy an object.</li> </ul>	<ul style="list-style-type: none"> <li>The pressure washer is too heavy to be lifted by one person. Obtain assistance from others before lifting.</li> </ul>

## Do not modify engine

To avoid serious injury or death, do not modify engine in any way. Tampering with the governor setting can lead to a runaway engine and cause it to operate at unsafe speeds. Never tamper with factory setting of engine governor.

## Notice Regarding Emissions

Engines containing 10% or less ethanol, which are certified to comply with California and federal EPA emission regulations for SORE (Small Off Road Equipment) and are certified to operate on regular unleaded gasoline, and may include the following emission control systems: Engine Modification (EM), Oxidizing Catalyst (OC), Secondary Air Injection (SAI) and Three Way Catalyst (TWC) if so equipped.











## Spark Arrestor

 **WARNING!** This product may not be equipped with a spark-arresting muffler. If the product is not equipped and will be used around flammable materials or on land covered with materials such as agricultural crops, forest, brush, grass or other similar items, then an approved spark arrester must be installed and is legally required in the state of California. It is a violation of California statutes section 130050 and/or sections 4442 and 4443 of the California Public Resources Code, unless the engine is equipped with a spark arrester, as defined in section 4442, and maintained in effective working order. Spark arresters are also required on some U.S. Forest Service land and may also be legally required under other statutes and ordinances.

A spark arrester for the muffler is available through your nearest engine authorized service dealer or contact the service department, 1-877-362-4271

## Safety Symbols

This page depicts and describes safety symbols that may appear on this product. Read, understand, and follow all instructions on the machine before attempting to assemble and operate.

Symbol	Description
	<b>READ THE OPERATOR'S MANUAL(S)</b> Read, understand, and follow all instructions in the manual(s) before attempting to assemble and operate.
	<b>DANGER — RISK OF FIRE OR EXPLOSION</b> Shut off engine and allow it to cool before adding fuel. Keep work area free of combustible materials. Do not spray flammable liquids.
	<b>WARNING— CARBON MONOXIDE</b> Never run an engine indoors or in a poorly ventilated area. Engine exhaust contains carbon monoxide, an odorless and deadly gas.
	<b>WARNING— RISK OF FLUID INJECTION</b> Fluid stream can penetrate skin and cause serious injury requiring immediate medical treatment.
	<b>WARNING - RISK OF SPRAY INJURY</b> Spray can propel objects. Always wear ANSI approved z87.1 safety glasses.
	<b>WARNING— RISK OF CHEMICAL BURN.</b> Never spray acids, corrosive or toxic chemicals. Use only cleaners formulated for pressure washers.
	<b>WARNING—RISK OF UNSAFE OPERATION.</b> Do not operate on a ladder. Gun kicks back - hold with both hands. Keep children away from this equipment.
	<b>WARNING— HOT SURFACE</b> Engine parts, especially the muffler, become extremely hot during operation. Allow engine and muffler to cool before before servicing or storing.
	<b>WARNING— RISK OF TIRE BURSTING.</b> Inflate tires slowly to rated pressure marked on tire. Do not attempt to spray tires with high pressure gun assembly. Read instruction manual.
	<b>WARNING— RISK OF INJURY.</b> Check high pressure hose for leaks prior to each use and replace if punctured or otherwise damaged. Do not check with your hands



**WARNING:** Your Responsibility—Restrict the use of this power machine to persons who read, understand and follow the warnings and instructions in this manual and on the machine.

**SAVE THESE INSTRUCTIONS!**

## Contents of Crate

- Pressure Washer (1)
- Operator's Manual (1)
- Engine Operator's Manual (1)
- Trailer Operation's Manual (1)
- Trailer (1)
- Pressure Washer Hose (1)
- Quick-Connect Spray wand (1)
- Quick Connect Spray Gun (1)
- Quick-Connect Nozzles (5)
- Trailer Tongue & Tongue Jack (1)

## Assembly

**NOTICE:** This unit is shipped with oil in the engine. This unit is shipped without gasoline in the engine. Fill up with gasoline as instructed and check oil level as instructed in the Engine Operator's manual BEFORE operating your pressure washer.

**NOTICE:** The high-pressure pump was filled with oil at the factory. Always check oil level before using (refer to Maintenance & Adjustments for more information).

### Nozzles

1. Remove the colored quick-connect nozzles from the plastic bag and insert them into correct grommet on the nozzle holder. Nozzles are color coded to match colored nozzles on label. See Figure 3-1.

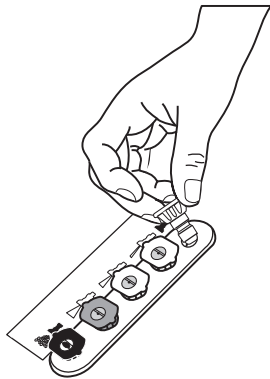

Figure 3-1

### Wand to Gun

1. Connect spray wand to spray gun. Tighten securely. See Figure 3-2.

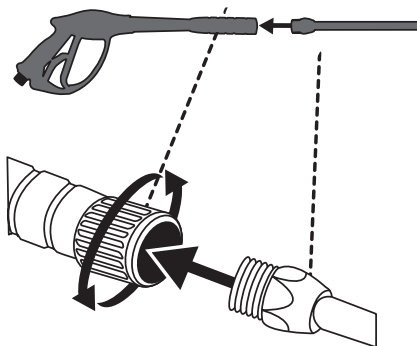

Figure 3-2

### Hose to Gun

1. Pull quick-connect coupler back on the hose and insert gun. Release quick-connect coupler and twist gun to make sure it is secure in coupler. See Figure 3-3.

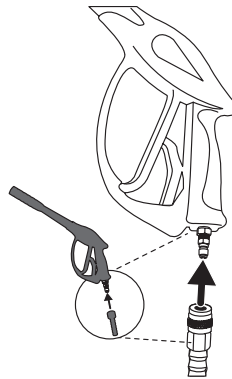

Figure 3-3

## Setup

### Gas and Oil Fill-Up

1. Add oil as instructed in the Engine Operator's manual before starting unit for the first time.
2. Service the engine with gasoline as instructed in the separate engine owner's manual.



**WARNING:** Use extreme care when handling gasoline. Gasoline is extremely flammable and the vapors are explosive. Never fuel the machine indoors or while the engine is hot or running. Extinguish cigarettes, cigars, pipes and other sources of ignition.

### Oil Recommendations

We recommend the use of Briggs & Stratton Warranty Certified oils for best performance. Other high-quality detergent oils are acceptable if classified for service SF, SG, SH, SJ or higher. Do not use special additives.

Outdoor temperatures determine the proper oil viscosity for the engine. Use the chart to select the best viscosity for the outdoor temperature range expected.

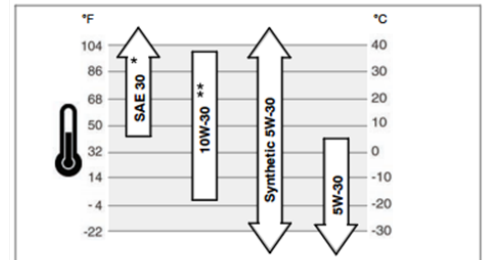

\* Below 40°F (4°C) the use of SAE 30 will result in hard starting.

\*\* Above 80°F (27°C) the use of 10W-30 may cause increased oil consumption. Check oil level more frequently.



**NOTE: Photographs and line drawings used in this manual are for reference only and do not represent a specific model.**

Compare the illustrations with your unit to familiarize yourself with the location of various controls and adjustments. Save this manual for future reference.

## **High Pressure Pump**

Located at the back of the engine. Increases the pressure of the water supply as it is forced through the high pressure hose and spray gun. Refer to

**Maintenance** section for more information.

## **High Pressure Hose & Reel**

Carries the pressurized water from the pump to the gun and spray wand.

## **Spray Gun Handle**

Connects with spray wand to control water flow rate, direction and pressure. Equipped with Dial-N-Wash pressure adjustment.

## **Spray Wand**

Allows the user to quickly change out high pressure nozzles. Refer to "How To Use Spray Wand" instructions in Operation section.

## **Detergent Siphon Hose (Not Shown)**

Feeds cleaning agents into the pump to mix with the water. See "How to Apply Chemicals/Cleaning Solvents" instructions.

## **Water Tank**

Large water reservoir tank for storage and transportation of water. Features an outlet to the pump inlet for dispensing water.

## **Tank Fill Hose**

Some models feature a hose and reel allowing to connect the water reservoir tank to a water source from a distance without introducing a stand-alone garden hose.

## **Hose Retainer**

Some models feature a short length of hose allowing to connect the reservoir tank to a water source with the use of a stand-alone garden hose.

## **Swing-Back Jack Stand**

Used to support the unit when not being towed.

## **Trailer Hitch**

Connects to ball mount on road vehicle for towing.

## **Trailer Light Harness**

Connect the taillight harness to the outlet on the rear of the towing vehicle. Always make sure that the red taillights function properly before towing.

## **Pressure Washer Terminology**

### **PSI**

Pounds per Square Inch. The unit of measure for water pressure.

### **GPM**

Gallons per Minute. The unit of measure for the flow rate of water.

### **CU**

Cleaning Units. GPM multiplied by PSI equals CU.

### **Bypass Mode**

Allows water to re-circulate within the pump when the gun trigger is not pulled. This feature allows the operator to release the trigger gun and reposition themselves without having to turn the engine off in between cleaning actions.

**NOTICE:** Allowing the unit to run for more than two minutes without the gun trigger being pulled could cause overheating and damage to the pump. Do not let the pressure washer run for more than two minutes in Bypass Mode. Turn off the engine and relieve the pressure in the gun during these extended situations.

## Transport and Setup

Make certain the trailer frame is securely balanced before adjusting the position.

Do not to use jack stand on uneven surfaces and tires should be blocked when lifting trailer off ball mount.

1. Secure the tow vehicle and trailer from rolling (by blocking wheels) when operating jack.
2. These jacks are designed for vertical loading.
  - Excessive side forces may cause jack failure and must be avoided.

The jack is not intended to be used as a transport device for the implement it is attached. Minimize movement of implement while jack is under load.

**NOTICE:** TOW trailer as level as possible. DO NOT operate on inclines.

## Trailer Tongue Installation

1. Unfasten and unwrap tongue assembly from trailer crate base.
2. Slide tongue assembly into slot located under the front section of the trailer.



TONGUE SLOT **Figure 5-1**

3. Slide light wiring through the tongue tube to the front end.
4. Check trailer light wire routing through tongue to make sure wires are not pinched, stretched, tangled or hung up.
5. The hardware is located on the front wire mesh tray. Mount tongue hardware through the tongue support angles and tongue tube and tighten. See below for reference on correct installation of hardware provided.

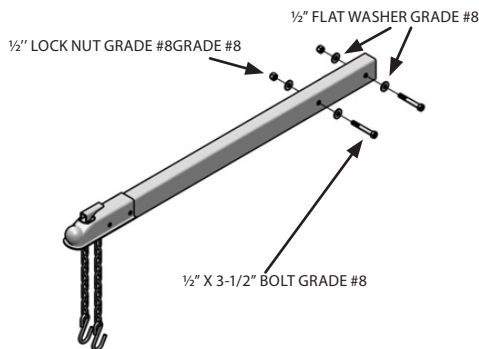

**Figure 5-2**

## To Tow the pressure washer:



**WARNING!** Do not tow faster than 55mph and check the local, state and federal requirements before towing on any public road.

6. Swivel down the jack and crank jack down further to take weight off the front wooden shipping supports. With the weight off the shipping posts, the wooden shipping supports box can be removed. See Figure 5-3.



WOODEN SHIPPING SUPPORTS

**Figure 5-3**

7. Remove ratchet tie down strap from rear of trailer.

## Thermal Relief Valve

When the temperature inside the pump rises too high, this valve will open and release a gush of water in an effort to lower the temperature inside the pump. The valve will then close. See Figure 5-4.

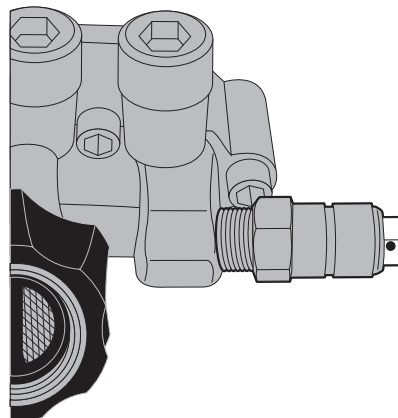

**Figure 5-4**

## Detergent Injection System

Mixes cleaners or cleaning solvents with the water to improve cleaning effectiveness.

## Water Supply

This unit is supplied with a water tank. Make sure the water in the tank is clean as debris can cause excess pump wear and reduce performance. Do not run dry.



**WARNING:** To reduce the possibility of contamination always protect against backflow when connected to a potable water system.

## Pressure Washer Operating Features

### Pressure Adjustments

The pressure setting is preset at the factory to achieve optimum pressure and cleaning. If you need to lower the pressure, it can be accomplished by these methods.

- Back away from the surface to be cleaned. The further away you are, the less the pressure will be on the surface to be cleaned.
- Change to the 40° nozzle (white). This nozzle delivers a less powerful stream of water and a wider spray pattern. Refer to "How To Use Spray Wand".
- Use the Dial-N-Wash to increase and decrease the pressure. Refer to the "Dial-N-Wash Adjustment" paragraph.

**NOTICE:** DO NOT attempt to increase pump pressure. A higher pressure setting than the factory set pressure may damage pump.

Figure 5-5

## How To Use Spray Wand

The nozzles for the spray wand are stored in the nozzle holder on the panel assembly. Colors on the panel identify nozzle location and spray pattern. Refer to the following chart to choose the correct nozzle for the job to be performed.

### Changing Nozzles on Spray Wand

**! DANGER!** Risk of fluid injection. Do not direct discharge stream toward persons, unprotected skin, eyes or any pets or animals. Serious injury will occur.

**! WARNING!** Flying objects could cause risk of serious injury. Do not attempt to change nozzles while pressure washer is running. Turn engine off before changing nozzles.

1. Pull quick-connect coupler back and insert nozzle.
2. Release quick-connect coupler and twist nozzle to make sure it is secure in coupler. See Figure 5-6.

**! WARNING!** Flying object could cause risk of serious injury. Ensure nozzle is completely inserted in quick-connect socket and quick-connect collar is fully engaged (forward) before squeezing gun trigger.

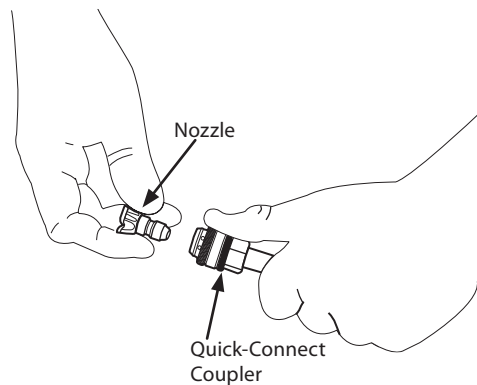

Figure 5-6

Nozzle Color	Spray Pattern	Uses	Surfaces*
Red	0° 	Powerful pinpoint for spot cleaning of hard, unpainted surfaces or for high reach areas	Unpainted metal or concrete; DO NOT use on wood
Yellow	15° 	Intense cleaning of unpainted hard surfaces	Grills, driveways, concrete or brick walkways, unpainted brick or stucco
Green	25° 	Standard cleaning nozzle for most applications	Yard tools, sidewalks, lawn furniture, unpainted siding, stucco, gutters and eaves, concrete, brick surfaces
White	40° 	Cleaning of painted or delicate surfaces	Auto/RV, marine, wood, painted brick and stucco, vinyl, painted siding
Black	low pressure 	Applies cleaning solution.	Low pressure spray is safe on all surfaces. Always verify compatibility of cleaning solution prior to use.

**\*NOTE:** The high pressure spray from your pressure washer is capable of causing damage to surfaces such as wood, glass, automobile paint, auto striping and trim, and delicate objects such as flowers and shrubs. Before spraying, check the item to be cleaned to assure yourself that it is strong enough to resist damage from the force of the spray.

### How To Apply Chemicals/Cleaning Solvents

Applying chemicals or cleaning solvents is a low pressure operation.

**NOTE:** Use only soaps and chemicals designed for pressure washer use. **Do not use bleach.**

#### To Apply Chemicals:

1. Ensure detergent siphon hose is attached to barbed fitting location near high pressure hose connection of pump as shown. See Figure 5-7.

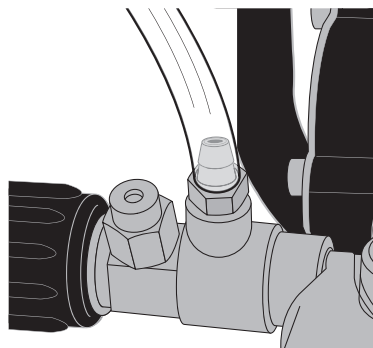

Figure 5-7

2. Place other end of detergent siphon hose with filter on it into container holding chemicals/cleaning solution.

**NOTE:** For every 7 gallons of water pumped, 1 gallon of chemical/cleaning solution will be used.

3. Install the black low pressure nozzle into the quick connect fitting of the spray wand and rotate the Dial-N-Wash to the MAX pressure setting as shown. See "How To Use Spray Wand" paragraph in this section.

**NOTE:** To apply chemicals the black low pressure nozzle must be installed and the Dial-N-Wash must be in the MAX pressure setting as shown.

4. After use of chemicals, place detergent siphon hose into container of clean water and draw clean water through chemical injection system to rinse system thoroughly. If chemicals remain in the pump, it could be damaged. Pumps damaged due to chemical residue will not be covered under warranty.

**NOTE:** Chemicals and soaps will not siphon if the black soap nozzle is not installed on the spray wand.

## Operation

### Starting

**! WARNING!** To reduce the risk of injury, read the pressure washer instruction manual and the engine instruction manual before starting pressure washer.

**! DANGER!** Risk of fluid injection and laceration. When using the high pressure setting, DO NOT allow the high pressure spray to come in contact with unprotected skin, eyes, or with any pets or animals. Serious injury will occur.

- Your washer operates at fluid pressures and velocities high enough to penetrate human and animal flesh, which could result in amputation or other serious injury. Leaks caused by loose fittings or worn or damaged hoses can result in injection injuries. DO NOT TREAT FLUID INJECTION AS A SIMPLE CUT! See a physician immediately!

**! DANGER!** Carbon Monoxide. Using an engine indoors can kill you in minutes. Engine exhaust contains high levels of carbon monoxide (CO), a poisonous gas you cannot see or smell. You may be breathing CO even if you do not smell engine exhaust.

- Breathing exhaust fumes will cause serious injury or death! Engine exhaust contains carbon monoxide, an odorless and deadly gas.
- Operate pressure washer in a well-ventilated area. Avoid enclosed areas such as garages, basements, etc.
- Never operate unit in or near a location occupied by humans or animals.

**! WARNING!** Risk of Fire, Asphyxiation and Burn. Never fill fuel tank when engine is running or hot. Do not smoke when filling fuel tank.

- Never fill fuel tank completely. Fill tank to 1/2" (12.7 mm) below bottom of filler neck to provide space for fuel expansion. Wipe any fuel spillage from engine and equipment before starting engine.

- DO NOT let hoses come in contact with very hot engine muffler during or immediately after use of your pressure washer. Damage to hoses from contact with hot engine surfaces will NOT be covered by warranty.

**NOTICE:** Risk of property damage. Never pull water supply hose to move pressure washer. This could damage the hose and/or pump inlet.

- Never turn water supply off while pressure washer engine is running or damage to the pump will result.
- DO NOT stop spraying water for more than two minutes at a time. Pump operates in bypass mode when spray gun trigger is not pressed. If pump is left in bypass mode for more than two minutes internal components of the pump can be damaged.

*If you do not understand these precautions, please contact our customer service department.*

Refer to engine manual for instructions on starting and operation the engine.

1. In a well ventilated outdoor area, add fresh, high quality unleaded gasoline with a pump octane rating of 86 or higher. Do not overfill. Wipe up spilled fuel before starting the engine. Refer to the Engine Operator's manual packed with your pressure washer for instructions.

**NOTICE:** Use of fuels with greater than 10% ethanol are not approved for use in this product per EPA regulations and will damage the unit and void the warranty. See Figure 5-8.

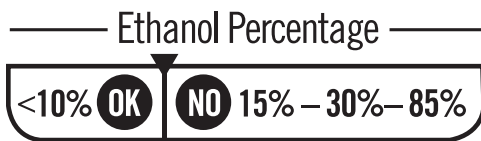

**Figure 5-8**

2. Check engine oil level. Refer to the Engine Operator's manual packed with your pressure washer for instructions.
3. Check pump oil level. The oil level should come to the dot in the middle of the sight glass. Refer to the "Pump" paragraph under Maintenance & Adjustments.
4. When filling the water tank remove all air from the hose.
5. Verify the filter screen is in the inlet of the water tank. Only applies to the CW3600 unit. See Figure 5-9.

**NOTE:** Convex side faces out.

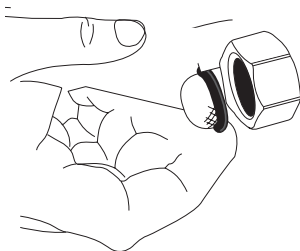

**Figure 5-9**



**WARNING!** To reduce the possibility of contamination always protect against a backflow when connected to a potable water system.

6. Choose the correct nozzle for the job to be performed. See "How To Use Spray Wand" instructions in this section.
 

**NOTE:** If applying a chemical or cleaning solution, see "How To Apply Chemicals/Cleaning Solvents" instructions in this section.

**NOTICE:** Risk of property damage. Failure to follow these instructions could result in damage to the pump.
7. Remove all air from the pump and high pressure hose by depressing trigger until a steady stream of water is present.
8. Start engine. Refer to the Engine Operator's manual packed with your pressure washer for starting instructions.



**WARNING!** Risk of unsafe operation. If engine does not start after two pulls, squeeze trigger of gun to relieve pump pressure. Pull starter cord slowly until resistance is felt. Then pull cord rapidly to avoid kickback and prevent hand or arm injury.

**NOTE:** If the oil level in the engine is low, the engine will not start. If the engine does not start, check the oil level and add oil as needed.

9. Depress trigger on gun to start water flow.



**WARNING!** Risk of unsafe operation. Stand on a stable surface and grip gun/spray wand firmly with both hands. Expect the gun to kick when triggered.

10. Release trigger to stop water flow.



**WARNING!** Risk of injury from spray. Always engage the trigger lock when gun is not in use. Failure to do so could cause accidental spraying. See Figure 5-12.



**Figure 5-10**

### **Shutting Down**

1. Depress trigger on gun and allow water to run until the spray wand is no longer hot to the touch.
2. If chemicals were applied, place the chemical siphon hose into a container of clean water and draw clean water through chemical injection system to rinse system thoroughly.

**NOTICE:** Risk of property damage. Failure to rinse the chemical system can cause damage to the high-pressure pump or the high-pressure water system.

3. Turn engine off. Refer to the engine manual for correct procedure.

**NOTICE:** Risk of property damage. NEVER run machine with water tank level below the pick up line while pressure washer engine is running or damage to pump will result.

4. Pull trigger on spray gun to relieve any water pressure in hose or spray gun.
5. Refer to Storage for proper storage procedures.

## Maintenance Schedule

Engine Oil	<ol style="list-style-type: none"> <li>1. Inspect</li> <li>2. Change</li> <li>3. Filter</li> </ol>	<ol style="list-style-type: none"> <li>1. Before each use</li> <li>2. After the first month or 20 hours; then every 6 months or 100 hours</li> <li>3. Every 100 hours</li> </ol>
Air Cleaner	<ol style="list-style-type: none"> <li>1. Inspect</li> <li>2. Clean</li> <li>3. Replace</li> </ol>	<ol style="list-style-type: none"> <li>1. Before each use</li> <li>2. Every 3 months or 50 hours (Service more frequently when used in area that has dust or small debris)</li> <li>3. Every year or 300 hours (Replace paper element only)</li> </ol>
Battery Level (if, applicable)	<ol style="list-style-type: none"> <li>1. Check</li> <li>2. Check Voltage</li> </ol>	<ol style="list-style-type: none"> <li>1. Monthly</li> <li>2. Monthly</li> </ol>
Engine Fuel Filter	<ol style="list-style-type: none"> <li>1. Replace</li> <li>2. Replace</li> </ol>	<ol style="list-style-type: none"> <li>1. 300 hours</li> <li>2. 6 months</li> </ol>
Spark Plug Maintenance	<ol style="list-style-type: none"> <li>1. Check/Adjust</li> <li>2. Replace</li> </ol>	<ol style="list-style-type: none"> <li>1. Every 6 months or 100 hours</li> <li>2. Every year or 300 hours</li> </ol>
Fuel Tanks	<ol style="list-style-type: none"> <li>1. Clean</li> </ol>	<ol style="list-style-type: none"> <li>1. Annually</li> </ol>
Pump Oil	<ol style="list-style-type: none"> <li>1. Inspect</li> <li>2. Change</li> </ol>	<ol style="list-style-type: none"> <li>1. Daily</li> <li>2. After first 25 hours, then every 3 months or 150 hours</li> </ol>
Spray Nozzles	<ol style="list-style-type: none"> <li>1. Replace</li> </ol>	<ol style="list-style-type: none"> <li>1. Every 6 months</li> </ol>
Quick Connects	<ol style="list-style-type: none"> <li>1. Replace</li> </ol>	<ol style="list-style-type: none"> <li>1. Annually (more offered, if required)</li> </ol>
Water Screen/ Filter	<ol style="list-style-type: none"> <li>1. Clean</li> </ol>	<ol style="list-style-type: none"> <li>1. Weekly</li> </ol>
High-Pressure Hose	<ol style="list-style-type: none"> <li>1. Replace</li> </ol>	<ol style="list-style-type: none"> <li>1. Annually (more offered, if required)</li> </ol>
Trailer Inspection	<ol style="list-style-type: none"> <li>1. Check Tire Condition</li> <li>2. Check/Tighten Lug Nuts</li> <li>3. Check/Grease Bearings</li> <li>4. Check Trailer Lighting</li> <li>5. Check Trailer Tongue Bolts</li> </ol>	<ol style="list-style-type: none"> <li>1. Monthly</li> <li>2. Monthly</li> <li>3. Monthly</li> <li>4. Before each use</li> <li>5. Monthly</li> </ol>

### General Recommendations

- Always observe safety rules when performing any maintenance.
- The warranty on this pressure washer does not cover items that have been subjected to operator abuse or negligence. To receive full value from warranty, operator must maintain the pressure washer as instructed here.
- Changing of engine-governed speed will void engine warranty.
- All adjustments should be checked at least once each season.
- Periodically check all fasteners and make sure these are tight.



**WARNING!** Risk of fire hazard. Always disconnect, spark plug wire, let the engine cool and release all water pressure before performing any maintenance or repair. The engine contains flammable fuel. Do not smoke or work near open flames while performing maintenance.



**WARNING!** Risk of burn hazard. When performing maintenance, you may be exposed to hot surfaces, water pressure or moving parts that can cause serious injury or death.

## Pump

**NOTE:** The Pump was filled with oil at the factory. Change the pump oil after the first 50 hours of operation and every 100 hours thereafter, or every 3 months.

### To Check Pump Oil

The oil level should come to the dot in the middle of the sight glass. See Figure 6-1.

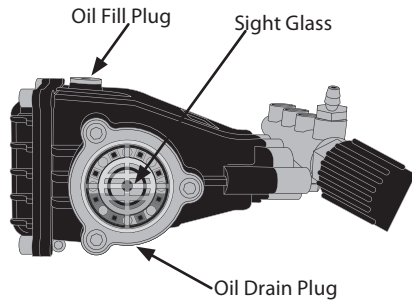

Figure 6-1

### To Change Pump Oil

1. Loosen pump oil fill plug
2. Place a container under the pump oil drain plug.
3. Remove pump oil drain plug.
4. After oil is drained, replace pump oil drain plug. Tighten securely.
5. Refill pump using oil recommended by pump manufacturer.
6. Replace pump oil fill plug and tighten securely.

## Connections

Connections on pressure washer hoses, gun and spray wand should be cleaned regularly and lubricated with light oil or lithium grease to prevent leakage and damage to the o-rings.

## Nozzle Cleaning

If the nozzle becomes clogged with foreign materials, such as dirt, excessive pressure may develop. If the nozzle becomes partially clogged or restricted, the pump pressure will pulsate. Clean the nozzle immediately using the nozzle kit supplied and the following instructions:

1. Shut off the pressure washer and turn off the water supply.
2. Pull trigger on gun handle to relieve any water pressure.
3. Disconnect the spray wand from the gun.
4. Remove the high pressure nozzle from the spray wand. Remove any obstructions with the nozzle cleaning tool provided and backflush with clean water. See Figure 6-2.

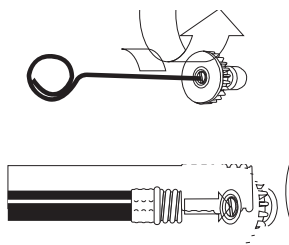

Figure 6-2

5. Direct water supply into nozzle to backflush loosened particles for 30 seconds.
6. Reconnect the nozzle to the wand.
7. Reconnect spray wand to gun and turn on water supply.
8. Start pressure washer and place spray wand into high pressure setting to test.

## Changing the Water Inlet Filter

This screen filter should be checked periodically and cleaned if necessary.

1. Remove filter by grasping end and removing it from the screen filter on the garden hose fitting to the water tank. .
2. Insert a new or cleaned a new filter into pump water inlet.

**NOTE:** Periodically check and clean the blue cap filter on the inlet of the pump.

**NOTE:** Convex side faces out. See Figure 6-3.

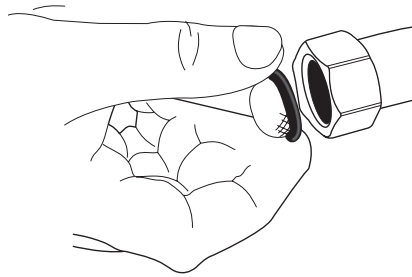

Figure 6-3

**NOTE:** Do not operate the pressure washer without the filter properly installed.

## Engine Care

A list of key engine maintenance jobs required for good performance by the pressure washer is given below. Follow the accompanying engine manual for a detailed list and instructions.

- Maintain oil level as instructed in engine manual
- Maintain oil level as instructed in engine manual.
- Service air cleaner as instructed in engine manual. Clean every few hours under extremely dusty conditions. Poor engine performance and flooding usually indicates that the air cleaner should be serviced. To service the air cleaner, refer to the engine manual.
- Clean spark plug and reset the gap once a season. Spark plug replacement is recommended at the start of each mowing season. Check engine manual for correct plug type and gap specifications.
- Clean engine regularly with a cloth or brush. Keep the top of the engine clean to permit proper air circulation. Remove all grass, dirt, and combustible debris from muffler area.
- Engines stored between 30 and 90 days need to be treated with a gasoline stabilizer to prevent deterioration and gum from forming in fuel system or on essential carburetor parts.

## Service

Do not return this product to your retailer without first contacting Simpson. Our contact information is located on the table of contents page.

## Off-Season Storage

The following steps should be taken to prepare your pressure washer for storage.

- Drain all water from high pressure hose and wrap it onto hose wrap. Drain all the water out of the water reservoir.
- Drain all water from the spray gun and wand by holding spray gun in a vertical position with nozzle end pointing down and squeezing trigger. Store in gun holder.
- Wrap up and secure detergent siphon hose so it is protected from damage.
- Refer to engine manual for correct engine storage instructions.
- Store pressure washer in a dry, clean area. Do not store next to corrosive materials, such as fertilizer.

When storing any type of power equipment in a poorly ventilated or metal storage shed, care should be taken to rust-proof the equipment. Using a light oil or silicone, coat the equipment, especially cables and all moving parts of your trailer before storage.

## Pump

The manufacturer recommends using a pressure washer pump cleaner when storing the unit more than 30 days or when freezing temperatures are expected.

**NOTE:** Using pump cleaner helps provide proper lubrication to the internal seals of the pump regardless of temperature or environment.

**NOTE:** Risk of property damage. Avoid products that are corrosive and/or contain alcohol which may cause pump damage.

1. Turn off pressure washer and disconnect hoses from pump.

**NOTE:** Prior to continuing, the water tank must be completely drained of water.

2. Unscrew bottle valve from bottle and remove seal.
3. Screw bottle valve back onto bottle.  
**NOTE:** In order to pour RV anti-freeze into the system, use a 2-way valve.
4. Attach bottle to water inlet of pump.
5. Squeeze bottle to inject contents into pump.
6. With ignition switch off, simultaneously pull starter rope and squeeze bottle. Repeat until protector fluid exits pump outlet.

**NOTE:** This step may require two people.

## WINTERIZATION:

1. Empty water tank.
2. Mix 1 part anti-freeze with 1 part water. Fill into water tank.
3. Remove nozzle from spray gun and pointed into water tank, turn on Engine and pull trigger until anti-freeze exits the spray gun back into water tank.
4. Shut off Engine.

Problem	Cause	Remedy
Engine will not start, refer to engine manual	<ol style="list-style-type: none"> <li>No fuel.</li> <li>Pressure builds up after two pulls on the recoil starter or after initial use.</li> <li>Choke lever in the "No Choke" position.</li> <li>Spark plug wire not attached.</li> </ol>	<ol style="list-style-type: none"> <li>Add fresh fuel. See engine manual.</li> <li>Squeeze gun trigger to relieve pressure.</li> <li>Move choke to the "Choke" position. See engine manual.</li> <li>Attach spark plug wire. See engine manual.</li> </ol>
No pressure or low pressure (initial use)	<ol style="list-style-type: none"> <li>Spray wand not in high pressure.</li> <li>Low water supply.</li> <li>Leak at high pressure hose fitting.</li> <li>Nozzle obstructed.</li> <li>Water filter screen clogged.</li> <li>Air in hose.</li> <li>Choke control in the "choke" position</li> <li>High Pressure Hose is too long.</li> </ol>	<ol style="list-style-type: none"> <li>See "How to Use Spray Wand" instructions in the Features and Controls Section.</li> <li>Water supply must be at least 5 gpm @ 20 PSI.</li> <li>Repair leak. Apply sealant tape if necessary.</li> <li>See "Nozzle Cleaning" instructions in the Maintenance section.</li> <li>Remove and clean filter. See "Cleaning Water Inlet Filter" paragraph in the Maintenance section for the correct procedure.</li> <li>Turn off the engine, then the water source. Disconnect the water source from the pump inlet and turn the water source on to remove all air from the hose. When there is a steady stream of water present, turn water source off. Reconnect water source to pump inlet and turn on water source. Squeeze trigger to remove remaining air.</li> <li>Move choke to the "No Choke" position. See engine manual.</li> <li>Use high pressure hose under 100 feet (30 m).</li> </ol>
Will not draw chemicals	<ol style="list-style-type: none"> <li>Spray wand not in low pressure.</li> <li>Chemical filter clogged.</li> <li>Chemical screen not in cleaning solution.</li> <li>Chemical too thick.</li> <li>Pressure hose is too long.</li> <li>Chemical build up in chemical injector.</li> </ol>	<ol style="list-style-type: none"> <li>See How to "Use Spray Wand" paragraph in the Features and Controls Section.</li> <li>Clean filter.</li> <li>Make sure end of detergent siphon hose is fully submerged into cleaning solution.</li> <li>Dilute chemical. Chemical should be the same consistency as water.</li> <li>Lengthen water supply hose instead of high pressure hose.</li> <li>See an authorized service dealer.</li> </ol>
No pressure or low pressure (after period of normal use)	<ol style="list-style-type: none"> <li>Worn seal or packing.</li> <li>Worn or obstructed valves.</li> <li>Worn unloader piston.</li> </ol>	<ol style="list-style-type: none"> <li>See an authorized service dealer.</li> <li>See an authorized service dealer.</li> <li>See an authorized service dealer.</li> </ol>
Water leaking at gun/spray wand connection	<ol style="list-style-type: none"> <li>Worn or torn o-ring.</li> <li>Loose hose connection</li> </ol>	<ol style="list-style-type: none"> <li>Check and replace.</li> <li>Tighten.</li> </ol>
Water leaking at pump	<ol style="list-style-type: none"> <li>Loose connections.</li> <li>Piston packings worn.</li> <li>Worn or torn o-ring.</li> <li>Pump head or tubes damaged from freezing.</li> </ol>	<ol style="list-style-type: none"> <li>Tighten.</li> <li>See an authorized service dealer.</li> <li>See an authorized service dealer.</li> <li>See an authorized service dealer.</li> </ol>
Pump pulsates	<ol style="list-style-type: none"> <li>Nozzle obstructed.</li> </ol>	<ol style="list-style-type: none"> <li>See "Nozzle Cleaning" in the Maintenance section for correct procedure.</li> </ol>
Oil leaking at pump	<ol style="list-style-type: none"> <li>Oil seals worn.</li> <li>Loose drain plug.</li> <li>Worn drain plug o-ring .</li> <li>Worn fill plug o-ring.</li> <li>Pump overfilled.</li> <li>Incorrect oil used.</li> <li>Vent plug is clogged.</li> <li>Air filter filled with oil.</li> </ol>	<ol style="list-style-type: none"> <li>See an authorized service dealer.</li> <li>Tighten.</li> <li>Check and replace.</li> <li>Check and replace.</li> <li>Check for correct amount.</li> <li>Drain and fill with correct amount and type of oil.</li> <li>Clean vent plug; blow air through it to remove any blockage. If problem persists, replace plug. See engine manual.</li> <li>Clean and/or replace filter element. See engine manual.</li> </ol>