



THE JESTER

Assembly and Safe Use Manual



This X-Stand™ product(s) has been tested to rigid industry standards. Safe operation and use of this X-Stand™ product(s) is the responsibility of the user(s). Please read and follow all safe use instructions and warnings. Failure to follow these may result in serious injury or death.
Second Edition, March 2018, Published by X-Stand™ Treestands, Lakeville Minnesota.

© 2018 X-Stand™ Treestands. All right reserved.

X-STAND.COM

**ATTENTION!! WHEN YOU SEE A “! WARNING!” BE SURE TO HEED THE MESSAGE!
THE INFORMATION CONTAINED IN THESE MESSAGES CAN SAVE YOUR LIFE!!**

HANG-ON AND CLIMBING SYSTEM SAFE USAGE INSTRUCTIONS & WARNINGS

XSFP436 - THE JESTER

Max. Weight Capacity (User(s) and Equipment) 350 lbs (159 kg)

! WARNING! This product carries strict weight restrictions. Please note that these weight limitations include the user(s) and their equipment. **DO NOT** use these product(s) if you exceed these total weight limitations. Failure to follow these instructions may result in serious injury or death!

A safe treestand hunting video, *Treestand Safety: It's Up To You*, has been included. Please view it in its entirety prior to using this product! Thank you for your purchase of this quality X-Stand™ Treestands product. To ensure your personal safety, please take a moment to carefully read this Instruction Manual in its entirety before attempting to assemble, set-up, install and/or otherwise use this X-Stand™ Treestands product. Failure to follow these instructions may result in serious injury or death!

Should you have any questions about the installation and/or use of this product, or any other X-Stand™ Treestands product(s) do not hesitate to call one of our customer service representatives at 540-877-2769 or visit X-Stand™ Treestands online at *X-Stand.com*. Our customer service representatives will answer any questions you may have about any of the complete line of X-Stand™ Treestands products.

Do not return this product to the retailer if you have any damaged or missing parts. Call X-Stand™ Treestands for replacement of any damaged or missing parts at 540-877-2769.

! WARNING! Failure to read and strictly comply with the instructions contained in this Instruction Manual may result in serious injury or death!

! WARNING! FALLS FROM A TREESTAND CAN OCCUR ANYTIME AFTER LEAVING THE GROUND. THESE FALLS COULD RESULT IN EITHER SERIOUS INJURY OR DEATH! FOR YOUR PERSONAL SAFETY, PLEASE TAKE A MOMENT TO CAREFULLY READ THIS PRODUCT INSTRUCTION MANUAL IN ITS ENTIRETY BEFORE ATTEMPTING TO ASSEMBLE, SET-UP, INSTALL AND/OR OTHERWISE USE THIS X-STAND™ PRODUCT. AT LEAST ANNUALLY, REVIEW THE CONTENTS OF THIS INSTRUCTION MANUAL AND WATCH THE SAFE TREESTAND HUNTING DVD. ADDITIONALLY, KEEP THESE INSTRUCTIONS FOR THE ENTIRE DURATION THAT YOU OWN THIS PRODUCT(S). FAILURE TO FOLLOW THESE INSTRUCTIONS MAY RESULT IN SERIOUS INJURY OR DEATH!

! WARNING! A *Treestand Safety: It's Up To You* DVD has been included with this treestand. Please view it in its entirety prior to using this or any other X-Stand™ product(s). Failure to follow these instructions may result in serious injury or death!

! WARNING! THE SAFE USE AND OPERATION OF THIS PRODUCT IS THE SOLE RESPONSIBILITY OF THE USER. IT IS ALSO THE SOLE RESPONSIBILITY OF THE OWNER TO PROVIDE ANY PERSON(S) WHO BORROW OR PURCHASE THIS PRODUCT WITH THESE INSTRUCTIONS AND THE AFORE MENTIONED *TREESTAND SAFETY: IT'S UP TO YOU* DVD. FAILURE TO FOLLOW THESE INSTRUCTIONS MAY RESULT IN SERIOUS INJURY OR DEATH! ADDITIONALLY, FAILURE TO FOLLOW THIS INSTRUCTION MAY SUBJECT YOU TO PERSONAL LIABILITY PENALTIES AS DETERMINED BY THE U.S. JUDICIAL SYSTEM.

! WARNING! Prior to each hunt, you must inform someone of your hunting location, including the specific location of your treestand and the expected duration of your hunt. Failure to follow these instructions may result in serious injury or death!

! WARNING! Prior to each hunt, make sure that you have a signaling device (e.g., mobile phone, radio, whistle, signal flare or Personal Locator Device (PLD)) in your possession and in an operable condition. This device must be within easy access should you experience the need to contact emergency assistance. Failure to follow these instructions may result in serious injury or death!

! WARNING! **DO NOT** remove, modify, and/or omit any portion or otherwise mechanically modify this X-Stand™ product(s) or its assemblies in any manner. Modification, misuse, and/or part substitution shall immediately void your factory warranty and may result in serious injury or death! If you suspect that a part(s) is missing and/or defective, immediately contact X-Stand™ at 540-877-2769 for replacement of missing or defective parts. Never modify your stand in any way by making repairs, or altering, adding or attaching anything to it except if explicitly authorized in writing by X-Stand™. **ALWAYS USE GENUINE FACTORY AUTHORIZED X-STAND™ REPLACEMENT PARTS. USE OF ANY REPLACEMENT PARTS OTHER THAN GENUINE X-STAND™ PARTS VOIDS YOUR WARRANTY AND MAY RESULT IN SERIOUS INJURY OR DEATH!**

! WARNING! **ALWAYS** inspect/check **ALL** expiration dates/tags on all straps and the full-body fall arrest harness and its components prior to each use. You must replace **ALL** straps and suspension seats **EVERY** year. Never use any strap(s) or full-body fall arrest harness or its components that has expired and/or is showing any signs of damage and/or wear. Failure to follow these instructions may result in serious injury or death!

! WARNING! Make certain all chains, cables, straps, etc. are tightened per this Instruction Manual prior to use. All treestand contact points must be in contact with the tree before you step onto the stand. The correct adjustment and tightening of attachment hardware is critical to the stable installation of this treestand. Additionally, you **MUST** be wearing your Fall Arrest System (FAS) which includes a full-body fall arrest harness, tree belt, lanyard/tether, suspension relief device and climbing belt/lineman's belt (as applicable) in accordance with the Instructions contained in this Instruction Manual. Failure to follow these instructions may result in serious injury or death!

! WARNING! This product(s) is designed for adult use only. No one under the age of 16 should attempt to use this or any other X-Stand™ product(s) without direct adult supervision. Failure to follow these instructions may result in serious injury or death!

! WARNING! Prior to attempting to use this or any other X-Stand™ product(s) you must take a moment and become familiar with its assembly, setup and installation. You must practice installing, setting-up and using your full-body fall arrest harness and its components (i.e., lanyard/tether, tree belt, suspension relief device, climbing belt/lineman's belt [as applicable]) at ground-level prior to attempting to use it at heights above ground-level. Once you have become thoroughly knowledgeable and comfortable with this X-Stand™ product(s) setup, installation and use at ground-level, you are now ready to use it at heights above ground-level. Failure to follow these instructions may result in serious injury or death!

! WARNING! Several X-Stand™ Treestands are equipped with a footrest, armrests and/or shooting rail. Neither the footrest, armrests nor the shooting rail have been designed to support the users weight. Under no circumstances should you place any more than fifteen (15) lbs (6 kg) of weight on these structures. Doing so will put the user in serious risk of injury or death. Failure to follow these instructions may result in serious injury or death!

! WARNING! You must wear a **Fall Arrest System (FAS)** comprising of a full-body fall arrest harness, tree belt, lanyard, suspension relief device and climbing belt/ lineman's belt (as applicable) at all times after leaving the ground. You must stay connected at all times after leaving the ground while using fixed position treestands. Single safety belts and chest harnesses are no longer allowed and should never be used. If you are not wearing a full-body fall arrest harness that is properly attached to the tree to protect you from a fall, do not leave the ground nor attempt to enter your treestand. Failure to follow these instructions may result in serious injury or death!

! WARNING! Never attempt to climb up or down with a weapon and/or gear in your possession. **ALWAYS** unload your weapon and pull it up to hunting height using a tether or pull up rope. **ALWAYS** lower your unloaded weapon down to the ground prior (when raising or lowering firearms, the chamber must be open and the barrel pointing toward the ground) to attempting to climb up or climb down. Use this same method when raising or lowering all other gear. Failure to follow these instructions may result in serious injury or death!

**ATTENTION!! WHEN YOU SEE A “! WARNING!” BE SURE TO HEED THE MESSAGE!
THE INFORMATION CONTAINED IN THESE MESSAGES CAN SAVE YOUR LIFE!!**

! WARNING! Prior to each use thoroughly inspect the treestand and all of its related components and all safety devices before use for signs of wear, rot, corrosion, cracks, deterioration and/or any other type of defect. Make certain that your treestand is tight and secure prior to use. Protect this product from extended exposure to direct sunlight, excessive heat or freezing temperatures by storing inside when not in use. **DO NOT** use this or any other product(s) if it shows evidence of wear, rot, corrosion, cracks, deterioration and/or any other type of defect. Failure to follow these instructions may result in serious injury or death!

! WARNING! DO NOT use this or any other X-Stand™ product(s) if you have a history of heart problems, back problems, impaired vision, joints that lock-up, spinal fusions, equilibrium problems, high blood pressure, are not well-rested and/or any other physical impairment that may limit your ability to use and/or operate this product(s) in the safe manner outlined in this Instruction Manual. Additionally, do not use this or any other X-Stand™ product(s) if you are currently taking medication (including prescription) and/or using and/or consuming any substance, including alcohol, that may limit your ability to use this X-Stand™ product(s) as outlined and described in the Instruction Manual. Never use a treestand when feeling ill, nauseous or dizzy. Failure to follow these instructions may result in serious injury or death!

! WARNING! DO NOT attempt to make adjustments to this product while in the treestand. All adjustments must be made with the entire treestand on the ground. Failure to follow these instructions may result in serious injury or death!

! WARNING! DO NOT leave your X-Stand™ product(s) installed for more than two weeks (14 days). Any number of factors can jeopardize its installation and integrity. These include, but are not limited to, weather or other environmental factors that can negatively affect its performance. Animals can also cause damage to your X-Stand™ product(s) that can negatively affect its performance and your safety. Additionally, factors such as tree growth can stress and damage supporting straps, cables, chains and/or buckles. Failure to follow these instructions may result in serious injury or death!

! WARNING! ALWAYS inspect the treestand and all safety devices prior to each use. **DO NOT** use this product(s) if it shows signs of wear, damage, deterioration, or vandalism. Factors such as tree growth, vandals, weather and animals may affect the performance of an unattended treestand. Failure to follow these instructions may result in serious injury or death!

! WARNING! DO NOT modify, fix/repair, alter, bend, cut, weld, drill or heat the treestand in any way. Also, do not attach anything to your treestand without explicit authorized and written instructions from the manufacturer. Failure to follow these instructions shall void warranty and may result in serious injury or death!

! WARNING! Strict weight limitations have been set for each product to ensure your personal safety. Note the weight limitations of your stand and that this weight limit includes the user (one person) and their equipment. **NEVER EXCEED THESE WEIGHT LIMITATIONS!** Failure to follow these instructions may result in serious injury or death!

! WARNING! DO NOT attempt to use this or any other X-Stand™ product(s) when ice, snow, and/or freezing rain has deposited or formed on any portion of the tree or stand you intend to climb. Do not attempt to use this or any other X-Stand™ product(s) when thunderstorms are threatening and/or present within five (5) miles. Do not attempt to use this or any other X-Stand™ product(s) when any other adverse weather condition presents itself. These include, but are not limited to, weather conditions which have the potential for producing winds, lightning, rain, snow, sleet and/or any other atmospheric condition which may limit the user's ability to operate this X-Stand™ product(s) in a safe manner as described in this Instruction Manual. Should inclement weather conditions arise during your use of this X-Stand™ product(s), return to the ground immediately. Failure to follow these instructions may result in serious injury or death!

! WARNING! DO NOT jump or bounce on the treestand platform and/or the seat to engage the stand to the tree. Failure to follow these instructions may result in serious injury or death!

! WARNING! BEFORE each use, make sure all nuts and bolts are secure. **CHECK** all hardware and webbing prior to every use to make sure that no damage has occurred to hardware and that webbing (as applicable) is not cut or frayed. Keep webbing from coming into contact with any sharp edges. **DO NOT USE THIS PRODUCT IF ANY DAMAGE IS SUSPECTED.** Failure to follow these instructions may result in serious injury or death!

! WARNING! REPLACE any damaged or worn part with original parts. Replace attachment straps every one year and when not in use store in a dry, cool, safe place away from sunlight. Never store a treestand or any of its components outdoors when not in use. To purchase parts contact X-Stand™ Treestands at 540-877-2769. Failure to follow these instructions may result in serious injury or death!

! WARNING! Always wear the appropriate foot wear when using a treestand. A good non-slip safety boot is important for your safety. Be especially careful that boot laces do not get hooked on the tree stand or its components (tuck shoelaces into boot before climbing). Failure to follow these instructions may result in serious injury or death!

! WARNING! DO NOT use this product, or attempt to use a treestand, on a dead, leaning, diseased, loose barked tree (bark that flakes or falls off), irregular shaped trees, or utility poles. **DO NOT** use this product on any tree that does not allow for a level standing platform. Failure to follow these instructions may result in serious injury or death!

! WARNING! NEVER hunt out of a treestand at heights at which you are not completely comfortable. Depending upon the tree and hunting conditions, choose the minimum hunting height that allows for safe, effective hunting. Failure to follow these instructions may result in serious injury or death!

! WARNING! DO NOT use this, or any other X-Stand™ product(s) to climb utility poles, telephone poles, structural columns or any other man-made structures. Never use this or any other X-Stand™ product(s) around power generation (e.g., transformers, generators, substations, etc.) and/or power transmission equipment. Never use a treestand on a dead, leaning, diseased or loose barked tree. **NEVER USE A TREE BRANCH, OR ANY PORTION OF A TREE, TO SUPPORT ANY PORTION OF YOUR WEIGHT OR AS A HAND HOLD.** Failure to follow these instructions may result in serious injury or death!

! WARNING! DO NOT stand on the treestand seat. Failure to follow these instructions may result in serious injury or death!

! WARNING! This X-Stand™ Treestand product(s) was designed for installation on trees with a minimum diameter of nine (9) inches (23 cm) to maximum diameter of twenty (20) inches (51 cm) at treestand installation height (i.e., seat height). **DO NOT** use your X-Stand product(s) on trees with trunk diameters that do not meet these diameter requirements. Failure to follow these instructions may result in serious injury or death!

! WARNING! Always maintain three-point contact when climbing up or down a tree. Proper three-point contact means having either two feet with one hand or one foot with two hands on the step portion of the ladder at all times when climbing up or down. Failure to follow these instructions may result in serious injury or death!

! WARNING! Never attempt to hunt from an unlevel standing and/or seating platform. Additionally, NEVER attempt to level your standing and/or seating platform at heights above the ground. Failure to follow these instructions may result in serious injury or death!

! WARNING! DO NOT jump or bounce on the treestand platform (or any of the treestands components) and/or the seat to engage the stand to the tree. Failure to follow these instructions may result in serious injury or death!

! WARNING! Climbing aids (e.g., stick ladders, sectional ladders, etc.) must be installed and extend a minimum of 24-inches (2 feet) above the seating platform. This practice allows the user to have a firm hand hold when stepping down onto the foot platform. NEVER attempt to step up onto your foot platform. Failure to follow these instructions may result in serious injury or death!

! WARNING! NEVER ATTEMPT to step onto a treestand until all treestand contact points are secured tightly and firmly to the tree. NEVER ATTEMPT to step onto a treestand unless your full-body fall arrest harness is properly attached. Failure to follow these instructions may result in serious injury or death!

! WARNING! NEVER ATTEMPT to step onto a treestand until all treestand contact points are secured tightly and firmly to the tree. NEVER ATTEMPT to step onto a treestand unless your full-body fall arrest harness is properly attached. Failure to follow these instructions may result in serious injury or death!

! WARNING! When installing your hang on treestand, you must wear your full-body fall

READ THIS MANUAL IN ITS ENTIRETY PRIOR TO USING THIS PRODUCT.

This instruction manual complies with ASTM F2123 Standard Practice for Treestand Instruction.

**ATTENTION!! WHEN YOU SEE A “! WARNING!” BE SURE TO HEED THE MESSAGE!
THE INFORMATION CONTAINED IN THESE MESSAGES CAN SAVE YOUR LIFE!!**

arrest harness and use the climbing belt at all times while installing or removing your fixed position treestand. The use of the climbing belt ensures your stable attachment to the tree until installation is complete. Failure to follow these instructions may result in serious injury or death!

! WARNING! When installing your treestand, never attempt to climb with your treestand in your possession. Always use a pull up rope to raise and lower the treestand during installation and removal. NEVER ATTEMPT TO CLIMB WITH ANY HUNTING COMPONENT OR ACCESSORY IN HAND OR ON YOUR BACK. Failure to follow these instructions may result in serious injury or death!

! WARNING! If you find that your treestand is unlevel, canted, angled awkwardly upward or downward, or in any configuration other than level, immediately climb down to ground-level and readjust your treestand as necessary to alleviate this awkward angle. Never attempt to hunt from an unlevel treestand. Additionally, never attempt to level your treestand at heights above the ground. Failure to follow these instructions may result in serious injury or death!

! WARNING! Never install, set-up, or climb to your treestand with a weapon. Use a pull-up rope to carefully raise your unloaded weapon after full-body fall arrest harness is secure and you are set in the stand!

! WARNING! AN ASTM compliant full-body fall arrest harness with a lineman's/climbing belt must be worn at all times while installing or removing any hang-on style treestands or climbing aids (i.e., ladders, sticks, steps, etc.). Failure to follow these instructions may result in serious injury or death!

! WARNING! DO not over tighten the hardware. Over tightening can lead to structural damage and may negatively affect the performance of your stand. Failure to follow these instructions may result in serious injury or death!

FULL-BODY FALL ARREST HARNESS USAGE INSTRUCTIONS & WARNINGS

! WARNING! Failure to read and strictly comply with the instructions contained here may result in serious injury or death!

! WARNING! READ ALL THE INFORMATION INCLUDED HERE PRIOR TO ATTEMPTING TO USE THIS FULL-BODY FALL ARREST HARNESS AND ITS COMPONENTS. YOUR FULL-BODY FALL ARREST HARNESS AND ITS COMPONENTS ARE DESIGNED FOR A MAXIMUM WEIGHT CAPACITY (USER AND EQUIPMENT) OF 350 POUNDS (159KG). ADDITIONALLY, YOUR FULL BODY FALL ARREST HARNESS AND ITS COMPONENTS MUST BE REPLACED AFTER THREE (3) YEARS OF SERVICE!

! WARNING! Prior to attempting to use this or any other X-Stand™ product(s) you must take a moment and become familiar with its assembly, setup and installation. You must practice installing, setting-up and using your full-body fall arrest harness at ground-level prior to attempting to use it at heights above ground-level. Once you have become thoroughly knowledgeable and comfortable with this product(s) setup, installation and use at ground-level, you are now ready to use it at heights above ground-level. Failure to follow these instructions may result in serious injury or death!

! WARNING! You must wear a **Fall Arrest System (FAS)** comprising of a full-body fall arrest harness, tree belt, lanyard, suspension relief device and climbing belt/lineman's belt (as applicable) at all times after leaving the ground. You must stay connected at all times after leaving the ground while using fixed position treestands. Single safety belts and chest harnesses are no longer preferred and should never be used. If you are not wearing a full-body fall arrest harness, do not leave the ground. Failure to follow these instructions may result in serious injury or death!

! WARNING! ALWAYS practice using your full-body fall arrest harness (FAS) in the presence of a responsible adult prior to using it in an elevated hunting environment, and learn what it feels like to hang suspended in the harness at ground level. Practice installing and using your treestand at ground level and with a responsible adult present before you go hunting.

! WARNING! The length of the full-body fall arrest harness tether must be kept to a minimum at all times during use. It should be adjusted so that it is above the head with no slack (snug) in the sitting position. Never allow the full-body fall arrest tether to get under your chin, around your neck, or under your arm(s). Failure to follow these instructions may result in serious injury or death!

! WARNING! Should you experience a fall there is time to make a correct decision on what action needs to take place. It is important to remember: **DO NOT PANIC!** Failure to follow this warning may result in serious injury or death!

! WARNING! If you have a limiting physical and/or health condition that precludes and/or renders you incapable of self-recovery and/or a suitable escape plan is not available, **DO NOT** hunt from heights above ground-level. Failure to follow these instructions may result in serious injury or death!

! WARNING! FALLS FROM A TREESTAND CAN OCCUR ANYTIME AFTER LEAVING THE GROUND. THESE FALLS COULD RESULT IN EITHER SERIOUS INJURY OR DEATH! FOR YOUR PERSONAL SAFETY, PLEASE TAKE A MOMENT TO CAREFULLY READ THIS PRODUCT INSTRUCTION MANUAL IN ITS ENTIRETY BEFORE ATTEMPTING TO ASSEMBLE, SET-UP, INSTALL AND/OR OTHERWISE USE THIS X-STAND™ PRODUCT. AT LEAST ANNUALLY, REVIEW THE CONTENTS OF THIS INSTRUCTION MANUAL AND WATCH THE SAFE TREESTAND HUNTING DVD. ADDITIONALLY, KEEP THESE INSTRUCTIONS FOR THE ENTIRE DURATION THAT YOU OWN THIS PRODUCT(S). FAILURE TO FOLLOW THESE INSTRUCTIONS MAY RESULT IN SERIOUS INJURY OR DEATH!

! WARNING! THE SAFE USE AND OPERATION OF THIS PRODUCT IS THE SOLE RESPONSIBILITY OF THE USER. IT IS ALSO THE SOLE RESPONSIBILITY OF THE OWNER TO PROVIDE ANY PERSON(S) WHO BORROW OR PURCHASE THIS PRODUCT FROM THEM WITH THESE COMPLETE INSTRUCTIONS. FAILURE TO FOLLOW THESE INSTRUCTIONS MAY RESULT IN SERIOUS INJURY OR DEATH! ADDITIONALLY, FAILURE TO FOLLOW THESE INSTRUCTIONS MAY SUBJECT YOU TO PERSONAL LIABILITY PENALTIES AS DETERMINED BY THE U.S. JUDICIAL SYSTEM.

**ATTENTION!! WHEN YOU SEE A “! WARNING!” BE SURE TO HEED THE MESSAGE!
THE INFORMATION CONTAINED IN THESE MESSAGES CAN SAVE YOUR LIFE!!**

! WARNING! Practice the use of your X-Stand™ Treestand full-body fall arrest harness and suspension relief device (SRD) at ground-level in the presence of a responsible adult to experience the feeling of hanging suspended before using in a hunting environment. Failure to follow these instructions may result in serious injury or death!

! WARNING! NEVER allow the full-body fall arrest harness lanyard/tether to get under your chin or around your neck. This poses a choking hazard that can lead to serious injury or death. Failure to follow these instructions may result in serious injury or death!

! WARNING! If your hunting location is unknown by anyone and communication efforts are unsuccessful, you must have a personal plan for self-recovery/escape should you experience a fall. Prolonged suspension in a full-body fall arrest harness can be fatal. It is important to exercise the legs by pushing against the tree or doing other forms of continuous leg exercises to avoid blood pooling while being suspended. Varying degrees of physical fitness may require different plans for self-recovery/escape the effects of prolonged suspension. Have a personal plan and practice it in the presence of a responsible adult before leaving the ground. No one escape/ rescue plan will work for every hunter, on every tree, in every circumstance. Only you can determine the best self-recovery/ escape plan for your hunting situation before leaving the ground. There is time to make a correct decision on what action to take if a fall occurs while wearing a full-body fall arrest harness. It is important to remember, **DO NOT PANIC**. Remain calm and implement your practiced rescue, relief and recovery plan. Hunt from the ground when a self-recovery/escape ability is absent. Failure to follow these instructions may result in serious injury or death!

! WARNING! TO REDUCE YOUR RISK OF INJURY OR DEATH FROM FALLS YOU MUST WEAR A LINEMAN STYLE (CLIMBING BELT) FULL-BODY FALL ARREST HARNESS THAT MEETS ASTM STANDARDS. ALWAYS REMAIN HARNESS TO THE TREE FROM THE MOMENT YOU LEAVE THE GROUND UNTIL YOU RETURN TO THE GROUND. The lineman's (climbing belt) style full-body fall arrest harness must be worn in compliance with the manufacturer's instructions. If you do not or cannot use a lineman's style (climbing belt) full-body fall arrest harness that properly fits you must, under no condition, attempt to use this or any X-Stand Treestand product(s).

! WARNING! When using a lineman's belt/climbing belt to ascend the tree, the full-body fall arrest harness tree belt and lanyard must be attached to the tree trunk before stepping down on the treestand. Failure to follow these instructions may result in serious injury or death!

FULL-BODY FALL ARREST HARNESS INSTRUCTIONS

! WARNING! READ THESE X-STAND™ TREESTANDS FULL-BODY FALL ARREST HARNESS INSTRUCTIONS CAREFULLY AND FOLLOW ALL THE INSTRUCTIONS! YOUR NEW FULL-BODY FALL ARREST HARNESS IS DESIGNED FOR A MAXIMUM CAPACITY (USER & EQUIPMENT) OF 300 POUNDS (136 KG). ADDITIONALLY, YOUR NEW FULL-BODY FALL ARREST HARNESS MUST BE REPLACED AFTER THREE (3) YEARS OF SERVICE! REPLACE YOUR HARNESS IMMEDIATELY SHOULD YOU EXPERIENCE A FALL WHILE WEARING IT.

! WARNING! You must use the X-Stand™ Treestand full-body fall arrest harness provided with this product or a harness that complies with ASTM standards. NOTE: You must store your full-body fall arrest harness out of direct sunlight and out of any other harsh environmental condition(s) that may adversely affect its performance. Failure to follow these instructions may result in serious injury or death!

STEP 1. Identify the main parts of the full-body fall arrest harness (see Fig. 1). Hold the full-body fall arrest harness by the tether loop ensuring the harness is upright and leg straps are hanging down. Straighten any parts that have become twisted. Insert arms through each shoulder strap. (see Fig. 2)

STEP 2. Feed the left leg strap between legs and thread through the bottom left waist loop. Repeat with the right leg strap, feeding between legs and through right waist loop. (see Fig. 3)

STEP 3. Secure the two leg straps by threading the 3 bar buckle as shown in Figure 4. Tighten the leg straps snugly. **DO NOT** over tighten as this will cut off the circulation to your legs. The X-Stand™ Treestands full-body fall arrest harness should look like the one depicted in Figure 6 when done correctly. Note : If leg straps are too long, feed right leg strap with buckle through bottom of the right waist loop, down the top of the right waist loop and secure to right leg strap with 3 Bar Buckle as instructed.

! WARNING! It is very important to complete this Step of the assembly. Improperly secured buckle may cause full-body fall arrest harness failure resulting in serious injury or death! If there is not enough strap available to complete this step, **DO NOT USE THIS FULL-BODY FALL ARREST HARNESS!** You may need to purchase and use a larger specialty sized full-body fall arrest harness that complies with ASTM standards.

STEP 4. If necessary to use a climbing belt for the field installation of your treestand (as per the specific Instructions for your specific treestand model), feed the climbing belt through one of the waist loops and wrap the free end around the tree. Then feed opposite end through the opposite waist loop and use 3 bar buckle method described (see Fig. 4) to secure. (see Fig. 5)

STEP 5. Once you have reached your desired height, insert the tree belt through the loop of the tether. (see Fig. 6) Then, carefully wrap the tree belt around the tree at a height that allows just enough slack for you to sit comfortably in your stand. Keeping the tether as short as possible limits the distance you will travel in the unlikely event you should experience a fall. To secure the tree belt insert free end up through the slot in the buckle closest to opposite end of the tree belt, then cross over the sliding mechanism and back down through opposite slot. Pull on strap to secure and test to make sure sliding mechanism engages creating secure strap placement. (see Fig. 7, 8, 9)

ATTENTION!! WHEN YOU SEE A “! WARNING!” BE SURE TO HEED THE MESSAGE! THE INFORMATION CONTAINED IN THESE MESSAGES CAN SAVE YOUR LIFE!!

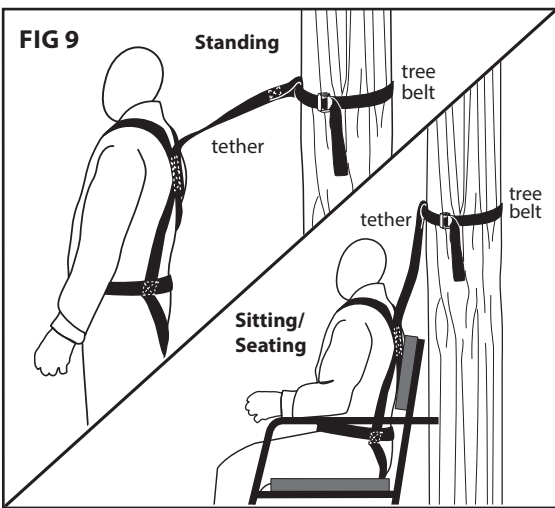
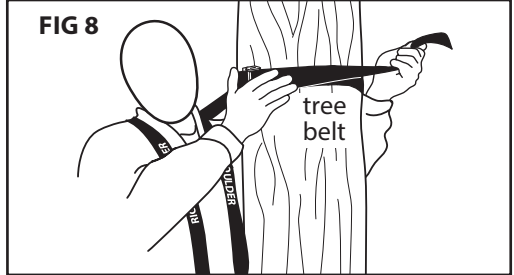
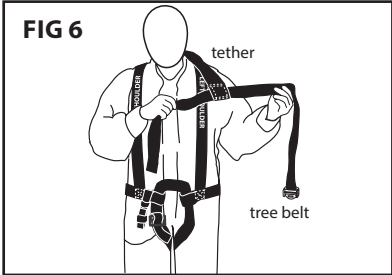
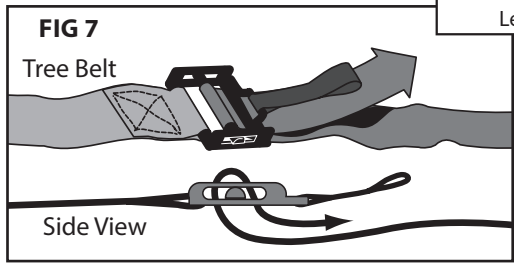
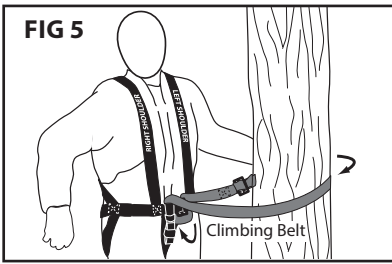
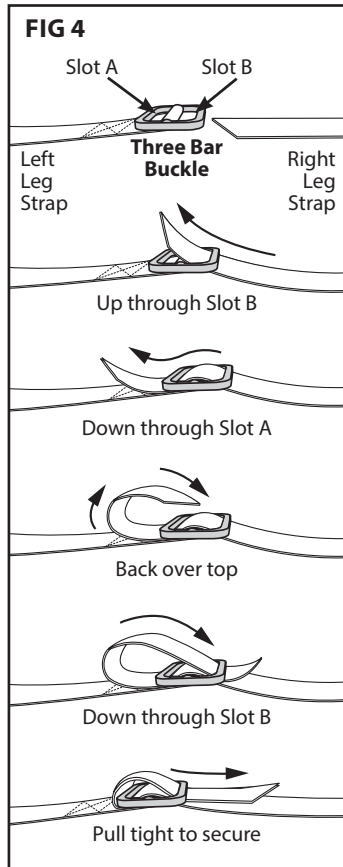
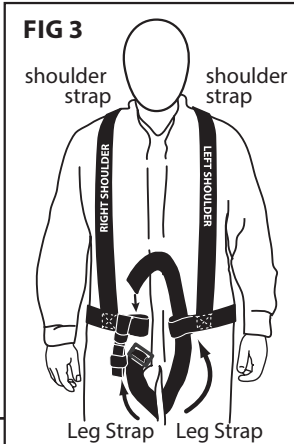
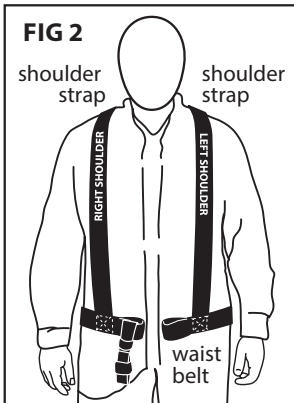
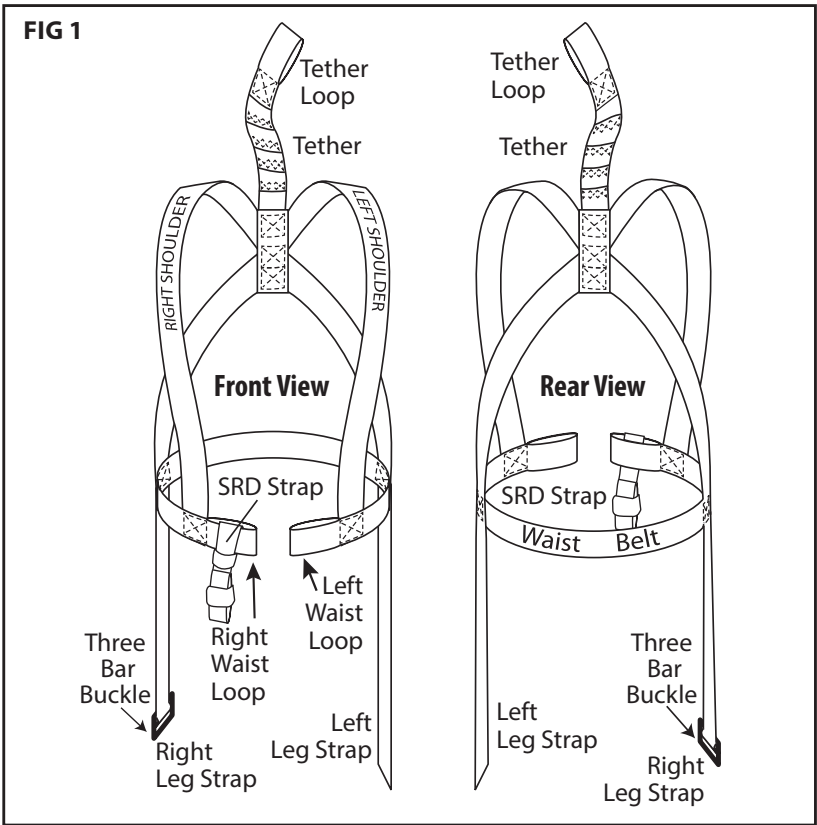

**ATTENTION!! WHEN YOU SEE A “! WARNING!” BE SURE TO HEED THE MESSAGE!
THE INFORMATION CONTAINED IN THESE MESSAGES CAN SAVE YOUR LIFE!!**

STEPS TO FOLLOW IF A FALL WERE TO OCCUR:

Although no one plans to fall from their treestand, falls can and do occur without warning. It is important to become familiar with the guidelines below and practice your recovery plan at ground-level. Failure to read, understand, and follow these Steps may result in serious injury or death!

! WARNING! There is time to make a correct decision on what action to take if a fall occurs while wearing a full-body fall arrest harness. It is important **NOT TO PANIC!** Remain calm and implement your practiced rescue, relief and recovery plan. Failure to follow these instructions may result in serious injury or death!

! WARNING! A suspension relief device must be on your person and readily accessible while using a full-body fall arrest harness. This device will allow you to relieve the load on the lower extremities if suspended in a full-body fall arrest harness and help maintain circulation in the legs and mitigate suspension trauma (blood pooling). Follow all instructions below regarding the provided **SRD** (Suspension Relief Device) and **NEVER** remove it from your full-body fall arrest harness. Failure to follow this warning may result in serious injury or death!

STEP 1. After a fall, take a moment to catch your breath and stay calm; **DO NOT PANIC.**

STEP 2. Pull on the **SRD strap** located on the front right side of your full-body fall arrest harness. (see Fig. 10)

STEP 3. Adjust the SRD strap so that you are able to step into the loop and then stand up relieving the pressure on your lower extremities. The loop size can be adjusted by moving the buckle up or down. (see Fig. 11 & 12)

STEP 4. If you are able to reach your ladder or climbing system, use it to get back into your secured treestand and then carefully climb down to ground-level. If you are not able to reach your stand, remain calm and continue to stand in the SRD loop until help arrives. (see Fig. 13)

STEP 5. Use your personal locating device or cell phone to call for help.

NOTE: Several optional commercial products/systems are available that offer self-recovery or self extraction from a fall when suspended in a full-body fall arrest harness. Some systems automatically descend the user while others allow user control. One of these products/systems can be considered for use as an additional safety precaution against prolonged suspension and suspension trauma. Be sure to follow the manufacturers' directions on the safe use of these products/systems.

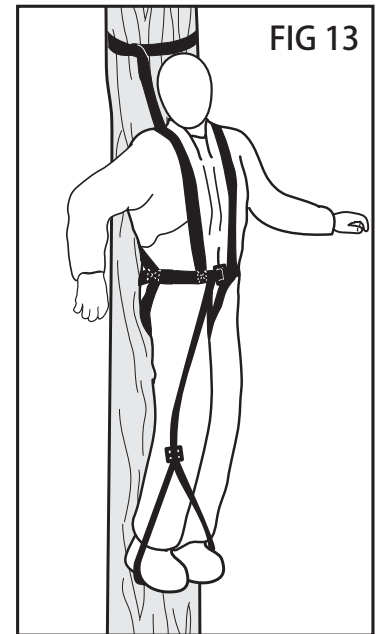
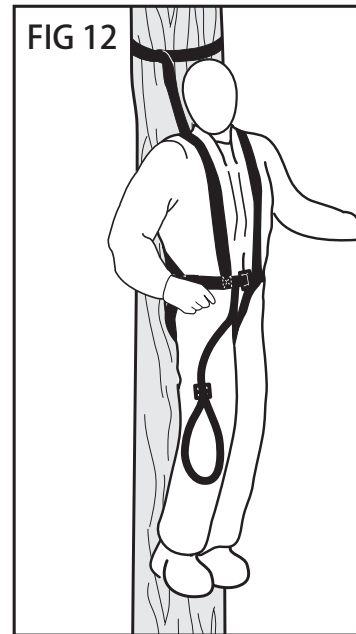
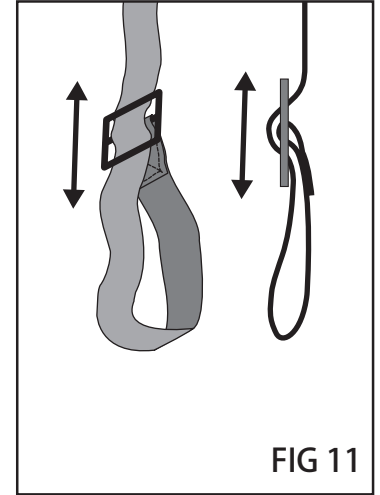
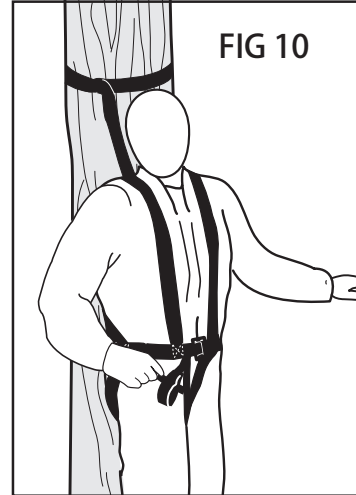

To activate your product's warranty, a registration card (found in the back of this manual) must be completed and returned to the manufacturer within 30 days of purchase.

Be sure to keep a copy of this card for your records.

Should you have any questions about the assembly, installation or use of this X-Stand product, or any other X-Stand products, please do not hesitate to call one of our customer service representatives at 540-877-2769 and they will answer all questions you may have about any of the complete line of X-Stand products.

READ THIS MANUAL IN ITS ENTIRETY PRIOR TO USING THIS PRODUCT.

This instruction manual complies with ASTM F2337 Standard Test Method for Treestand Fall Arrest Systems.

THE JESTER - PARTS LIST

Part #	Description	Qty	Part #	Description	Qty
XP17-0220	Foot Platform	1	XP15-0009	Full-Body Fall Arrest Harness	1
XP17-0223	Rear Frame Support	1	XP17-0250	Snap Pin	1
XP17-0238	Armrest	2	XP87-0072	5/16" x 1 1/2" Hex Bolt {A}	2
XP17-0241	Quick Hitch	1	XP87-0069	5/16" x 2" Hex Bolt {B}	4
XP17-0244	Tension Bar	2	XP87-0057	5/16" x 2 1/4" Hex Bolt {C}	2
XP17-0253	Plastic Coated Cable	2	XP87-0071	5/16" x 2 1/2" Hex Bolt {D}	2
XP17-0256	Seat Assembly	1	XP87-0067	5/16" x 2 3/4" Hex Bolt {E}	2
XP17-0226	Seat Support - Left	1	XP87-0063	1/4" x 1 1/2" Allen Bolt {F}	2
XP17-0229	Seat Support - Right	1	XP87-0049	Tension Bolt	2
XP17-0259	Backrest Assembly	1	XP87-0047	5/16" Nylock Nut	12
XP17-0232	Backrest Frame - Left	1	XP87-0029	1/4" Nylock Nut	2
XP17-0235	Backrest Frame - Right	1	XP87-0025	3/8" Nylon Spacer	2
XP17-0262	Armrest Cover	2	XP87-0027	Nylon Washer	46
XP17-0274	Ratchet Strap	2	XP87-0083	Allen Wrench	1
XP15-0020	Safety DVD	1	XP17-0290	Instruction Manual	1

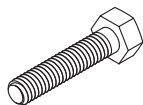

[A] 5/16" x 1 1/2" Hex Bolt
{2 Pieces}

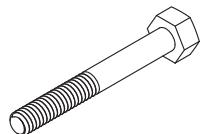

[B] 5/16" x 2" Hex Bolt
{4 Pieces}

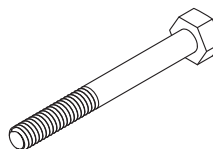

[C] 5/16" x 2 1/4" Hex Bolt
{2 Pieces}

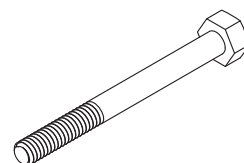

[D] 5/16" x 2 1/2" Hex Bolt
{2 Pieces}

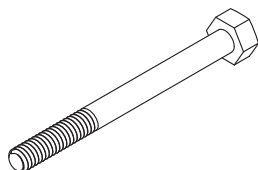

[E] 5/16" x 2 3/4" Hex Bolt
{2 Pieces}

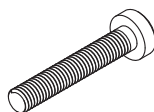

[F] 1/4" x 1 1/2" Allen Bolt
{2 Pieces}

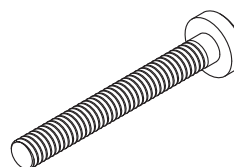

Tension Bolt
{2 Pieces}



5/16" Nylock Nut
{12 Pieces}



1/4" Nylock Nut
{2 Pieces}

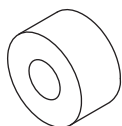

3/8" Nylon Spacer
{2 Pieces}



Nylon Washer
{46 Pieces}

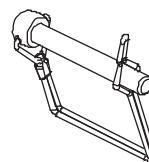

Snap Pin {1 Piece}



Allen Wrench {1 Piece}

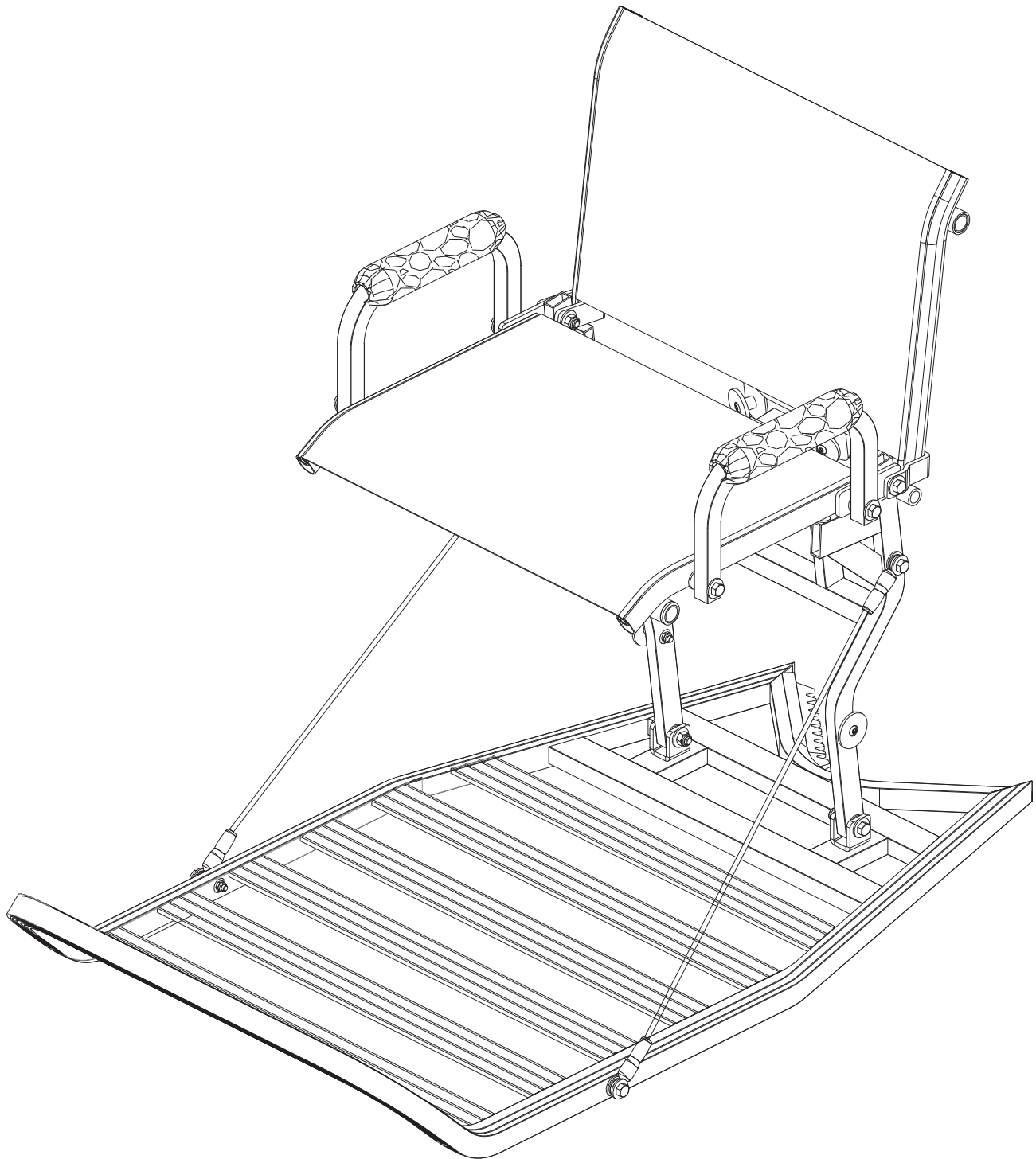

READ THIS MANUAL IN ITS ENTIRETY PRIOR TO USING THIS PRODUCT.

This instruction manual complies with ASTM F2123 Standard Practice for Treestand Instruction.

ASSEMBLY INSTRUCTIONS

XSFP436 - THE JESTER

STOP NOW! It will be necessary to use the climbing belt with your full-body fall arrest harness while ascending the tree and attaching your treestand. As you climb it will be necessary to slide the climbing belt up the tree. Once you've reached the desired height and your treestand is properly secured to the tree, you will need to attach the permanent tree belt and secure tether strap as illustrated on page 5 of this manual. FAILURE TO WEAR YOUR FULL-BODY FALL ARREST HARNESS AT ALL TIMES WHILE USING THIS PRODUCT MAY RESULT IN SERIOUS INJURY OR DEATH!

▲ WARNING! Prior to installing your X-Stand hang-on treestand, you must install a climbing system (i.e., stacking sticks, ladders, sectionals, etc.) which meets or exceeds ASTM standards. Failure to follow these instructions may result in serious injury or death!

▲ WARNING! DO NOT attempt to install this product on a tree that is not straight, healthy, and devoid of dead branches, limbs, vines, or anything that might interfere with the installation. DO NOT attempt to install this treestand on a tree that is leaning, diseased, crooked, has loose bark, or does not meet the minimum installation diameter of nine (9) inches (23 cm) at treestand height (i.e. seating platform height) or exceeds the maximum installation diameter of twenty (20) inches (51 cm) at treestand height (i.e. seating platform height).

Failure to follow these instructions may result in injury or death!

STEP 1. Attach the rear frame support to the platform using two (2) 5/16" x 2" hex bolts {B}, eight (8) nylon washers and two (2) 5/16" nylock nuts. Tighten securely.

STEP 2. Securely fasten each of the two plastic coated cables to the foot platform using two (2) 5/16" x 2" hex bolts {B}, six (6) nylon washers and two (2) 5/16" nylock nuts.

STEP 3. Securely fasten the other two ends of the plastic coated cables on each side of the rear frame support using two (2) 5/16" x 1 1/2" hex bolts {A}, six (6) nylon washers and two (2) 5/16" nylock nuts.

STEP 4. Attach the seat assembly to the top of rear frame support aligning holes. Then attach the backrest assembly to the seat assembly and rear frame support using two (2) 5/16 x 2 1/4" hex bolts {C}, twelve (12) nylon washers and two (2) 5/16" nylock nuts. Tighten securely.

STEP 5. Securely fasten the armrests to each side of the seat assembly using two (2) 5/16"x 2 1/2" hex bolts {D}, two (2) 5/16"x 2 3/4" hex bolts {E}, ten (10) nylon washers, two (2) nylon spacers and four (4) 5/16" nylock nuts. Attach the armrest covers.

STEP 6. Slip the quick hitch into the rear frame support, wrap the snap pin closure and secure over end of the pin. **NOTE:** The snap pin will be used to set the desired length of the quick hitch.

STEP 7. Securely attach one tension bar by inserting it through the front of seat assembly using one (1) 1/4" x 1 1/2" allen bolt {F}, two (2) nylon washers and one (1) 1/4" nylock nut. Repeat the backrest tension bar on the backrest assembly. **NOTE:** The tension bolts must be threaded completely into the tension bars for proper assembly.

Recheck every nut and bolt at this time for tightness.

FIGURE 1

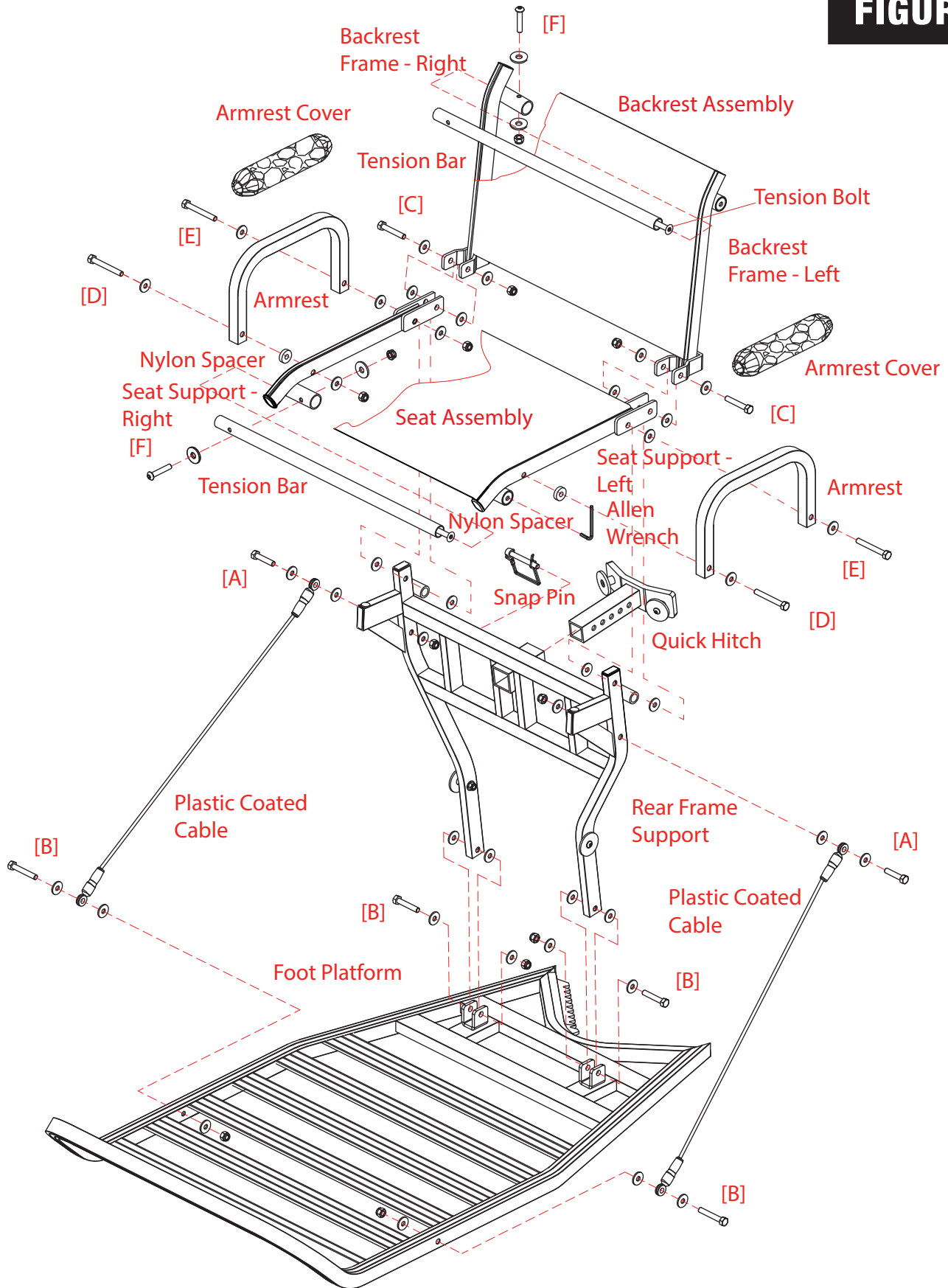

READ THIS MANUAL IN ITS ENTIRETY PRIOR TO USING THIS PRODUCT.

This instruction manual complies with ASTM F2123 Standard Practice for Treestand Instruction.

FIELD INSTALLATION

- THE JESTER -

STEP 1. Select a straight healthy tree, one devoid of dead branches with a minimum diameter of 9" (23 cm) and one that does not exceed 22" (56 cm) in diameter.

STEP 2. With your climbing system which meets or exceeds ASTM standards installed as outlined in the Manufacturer's Instruction Manual, you are now ready to install your treestand. Always maintain three points of contact when climbing up/down climbing systems. Always use a pull-up (hoist) rope to raise and lower your treestand. Never climb with anything on your back.

STEP 3. Place the included installation ratchet straps on your person (do not hold in hand).

STEP 4. Tie your pull-up (hoist) rope to your hang-on treestand in a way that you secure the seat portion to the foot platform to keep the treestand from opening when being hoisted. Should the treestand open while being pulled-up (hoisted) it will become awkward and dangerously clumsy.

STEP 5. With your treestand attached to the pull-up (hoist) rope, and the tag-end in your possession (do not hold in hand), check to ensure your linesman belt is properly secured to you and the linesman/climbing belt is attached to the tree and carefully climb to the desired height.

STEP 6. Once you reach the desired treestand installation height, re-check to ensure your climbing belt is properly secured to you and the tree. Make certain you are

balanced and secure on your climbing system. Next pull-up (hoist) your hang-on treestand.

STEP 7. With your treestand folded with the foot platform in the upright position and firmly in hand, place your treestand against the tree. (Fig. 1) Wrap the ratchet strap around the tree and secure it to the strap posts on either side of your treestand. (Fig. 1 and Fig. 2) **NOTE:** Make certain the ratchet strap is not twisted. If the ratchet strap is twisted, remove and reattach so it is not twisted. Remove the slack from the ratchet strap by pulling on the tag-end of the strap. Engage the ratchet strap and ratchet until the strap is tight. Repeat this process for the second ratchet strap.

STEP 8. Lower foot platform to standing position; the treestand will then snug up to the tree to prevent any shifting. Repeat as necessary to accomplish a snug fit to the tree. (Fig. 3)

STEP 9. Before stepping onto the foot platform, be sure it is secured properly and is tight against the tree with all contact points touching the tree. With your climbing belt, tree belt and tether connected to the tree trunk tightly and firmly. Carefully step onto the foot platform to be sure you have a solid feel against the tree. The seat with armrests folds down for sitting or up for standing. (Fig. 4)

STEP 10. Carefully pull up your unloaded weapon.

HANG ON INSTALL - FIGURE 1

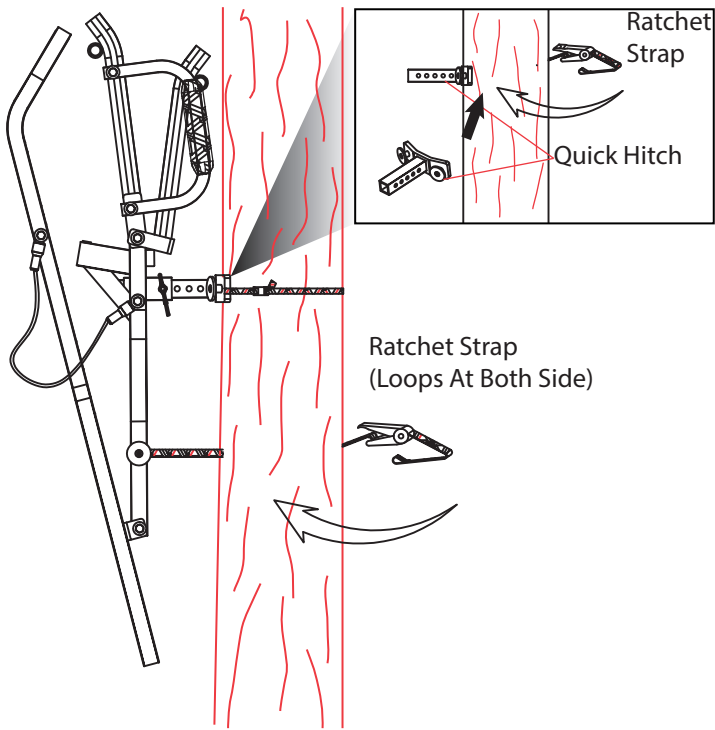

HANG ON INSTALL - FIGURE 2

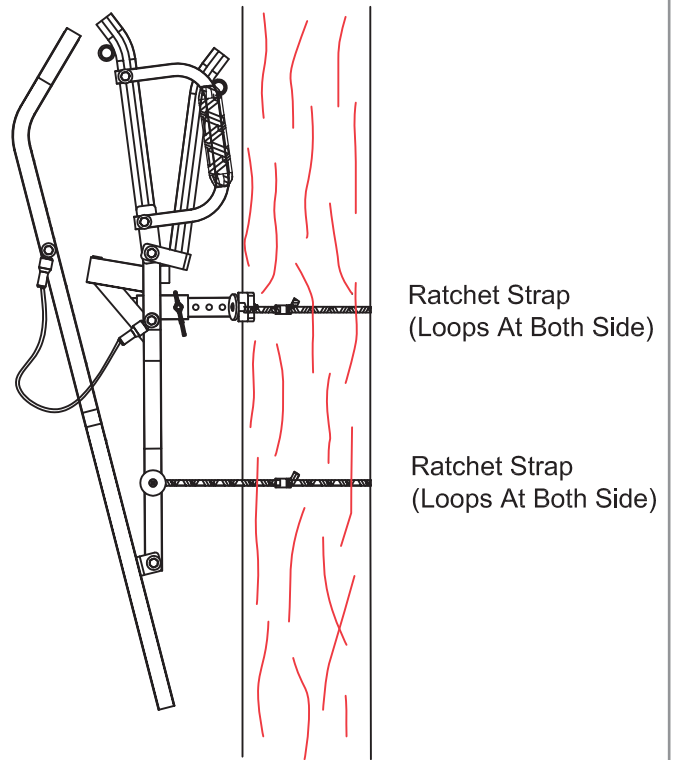

HANG ON INSTALL - FIGURE 3

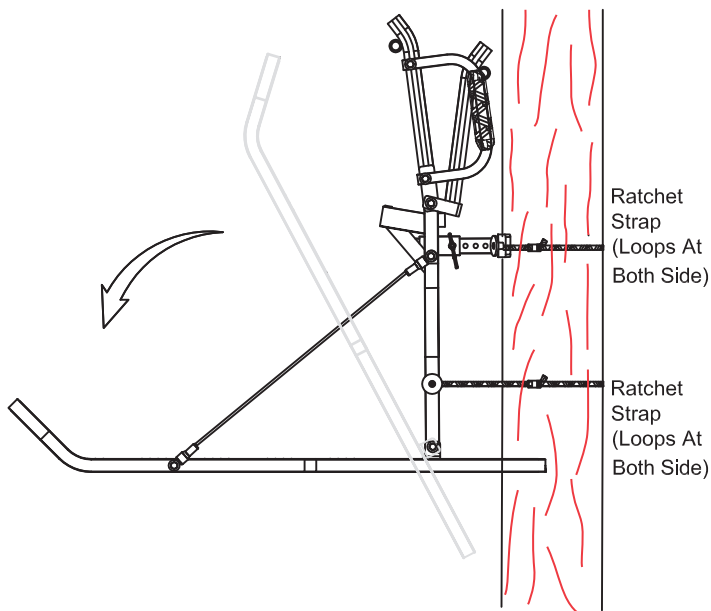

HANG ON INSTALL - FIGURE 4

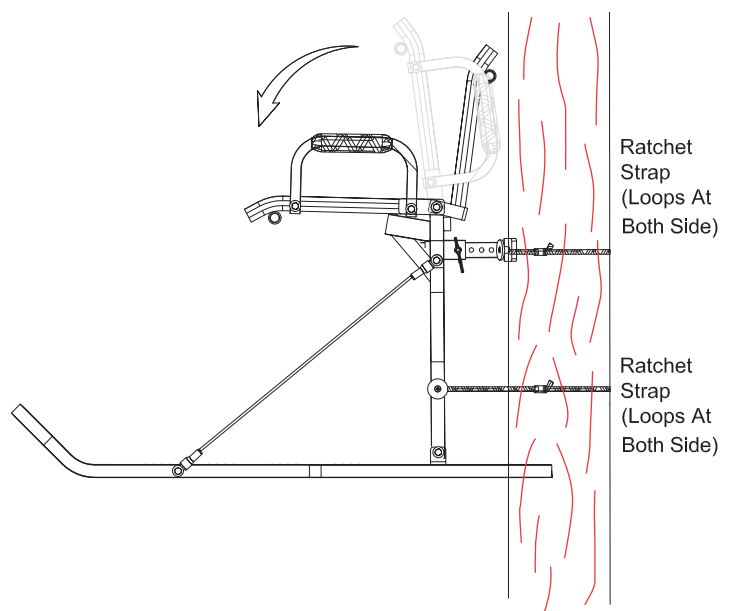

READ THIS MANUAL IN ITS ENTIRETY PRIOR TO USING THIS PRODUCT.

This instruction manual complies with ASTM F2123 Standard Practice for Treestand Instruction.



ATTENTION!! WHEN YOU SEE A “WARNING!” BE SURE TO HEED THE MESSAGE! THE INFORMATION CONTAINED IN THESE MESSAGES CAN SAVE YOUR LIFE!!

HANG-ON AND CLIMBING SYSTEM WARNINGS & PRODUCT REGISTRATION

⚠ WARNING! DO NOT jump or bounce on the treestand platform (or any of the treestands components) and/or the seat to engage the stand to the tree. Failure to follow these instructions may result in serious injury or death!

⚠ WARNING! Climbing aids (e.g., stick ladders, sectional ladders, etc.) must be installed and extend a minimum of 24-inches (2 feet) above the seating platform. This practice allows the user to have a firm hand hold when stepping down onto the foot platform. NEVER attempt to step up onto your foot platform. Failure to follow these instructions may result in serious injury or death!

⚠ WARNING! NEVER ATTEMPT to step onto a treestand until all treestand contact points are secured tightly and firmly to the tree. NEVER ATTEMPT to step onto a treestand unless your full-body fall arrest harness is properly attached. Failure to follow these instructions may result in serious injury or death!

⚠ WARNING! NEVER ATTEMPT to step onto a treestand until all treestand contact points are secured tightly and firmly to the tree. NEVER ATTEMPT to step onto a treestand unless your full-body fall arrest harness is properly attached. Failure to follow these instructions may result in serious injury or death!

⚠ WARNING! When installing your hang on treestand, you must wear your full-body fall arrest harness and use the climbing belt at all times while installing or removing your fixed position treestand. The use of the climbing belt ensures your stable attachment to the tree until installation is complete. Failure to follow these instructions may result in serious injury or death!

⚠ WARNING! When installing your treestand, never attempt to climb with your treestand in your possession. Always use a pull up rope to raise and lower the treestand during installation and removal. NEVER ATTEMPT TO CLIMB WITH ANY HUNTING COMPONENT OR ACCESSORY IN HAND OR ON YOUR BACK. Failure to follow these instructions may result in serious injury or death!

⚠ WARNING! If you find that your treestand is unlevel, canted, angled awkwardly upward or downward, or in any configuration other than level, immediately climb down to ground-level and readjust your treestand as necessary to alleviate this awkward angle. Never attempt to hunt from an unlevel treestand. Additionally, never attempt to level your treestand at heights above the ground. Failure to follow these instructions may result in serious injury or death!

⚠ WARNING! Never install, set-up, or climb to your treestand with a weapon. Use a pull-up rope to carefully raise your unloaded weapon after full-body fall arrest harness is secure and you are set in the stand!

⚠ WARNING! A ASTM compliant full-body fall arrest harness with a lineman's/climbing belt must be worn at all times while installing or removing any hang-on style treestands or climbing aids (i.e., ladders, sticks, steps, etc.). Failure to follow these instructions may result in serious injury or death!

To activate your product's warranty, please mail in your registration card or submit it online at www.X-Stand.com

Product Purchased _____ Model Number _____

Serial Number _____

Owner's Name _____

Street Address _____

City _____ State _____ Zip Code _____

E-mail Address _____ Phone _____

Date Purchased _____

Purchased From (Dealer Name) _____

How did you hear about us: Catalog Webpage Friend Magazine

Other, Please Explain _____

Are you a: Bow Hunter Gun Hunter Both

Treestand Preference: Fixed Position Climbing Ladderstand

X-Stand Treestands | 21673 Cedar Avenue South | Lakeville, MN 55044

STANDARD LIMITED WARRANTY

Warranty: X-Stand™ Treestands warrant all X-Stand™ treestands, climbing system products and hunting accessories to be free from defects in material and workmanship for a period of twelve months from the original date of retail purchase. X-Stand™ Treestands warrants the enclosed hardware (where applicable) is delivered to be free from physical defects for a period of twelve months from the original date of retail purchase.

Repair Procedures, Exclusive Remedy: X-Stand™ Treestands will at its option, repair, or replace products not conforming to this limited warranty at no charge. THIS IS THE SOLE AND EXCLUSIVE REMEDY AVAILABLE FOR BREACH OF WARRANTY OR UNDER ANY OTHER LEGAL THEORY WITH RESPECT TO X-STAND™ Treestands. If you find a product to be defective, contact the customer service department at 540-877-2769. When you receive authorization, return the product as directed at your expense. Product repairs not covered by warranty, and product updates, will be provided at a set rate.

Limitations: This warranty is void if the product is damaged by improper or abnormal use or by accident; if the product is altered or modified in any way other than those directed by official X-Stand™ Treestands instructions; or if any attempt is made to repair the product without authorization from X-Stand™ Treestands. It is solely the purchaser's responsibility to determine the suitability of these products for each particular application. X-Stand™ Treestands products are intended for hunting and hunting only. X-Stand™ Treestands are in all events not suitable, and are not authorized, for use in any situations that might pose potentially injurious to life and health, other than those situations that the products are intended for. This warranty is not assignable or transferable.

No Other Warranties: EXCEPT AS PROVIDED IN THIS LIMITED WARRANTY SET FORTH IN THE WARRANTY CARD SUPPLIED WITH X-STAND™ TREESTANDS AND INSTRUCTION SHEETS ARE PROVIDED "AS IS". ALL OTHER WARRANTIES AND REPRESENTATIONS, ORAL OR WRITTEN, EXPRESSED OR IMPLIED, INCLUDING BUT NOT LIMITED TO ANY IMPLIED WARRANTIES OF MERCHANTABILITY OR FITNESS FOR A PARTICULAR PURPOSE, ARE EXCLUDED AND DO NOT APPLY. THERE ARE NO WARRANTIES WHICH EXTEND BEYOND THE DESCRIPTION ON THE FACE HERE OF. Except as required by law, no representative, agent or employee of X-Stand™ Treestands is authorized to make warranties, representations, or obligations inconsistent with or in addition to those set forth in this limited warranty.

No Damages: IN NO EVENT WILL X-STAND™ Treestands BE LIABLE FOR DIRECT, INDIRECT, SPECIAL, INCIDENTAL, OR CONSEQUENTIAL DAMAGES RESULTING FROM BREACH OF WARRANTY OR UNDER ANY OTHER LEGAL THEORY, even if advised of the possibility of such damages. In no event will X-Stand™ Treestands be liable for sums in excess of the purchase price of the product. X-Stand™ Treestands is thus not liable for lost profits or goodwill; downtime; damage or destruction of items or equipment used with, or in conjunction with, X-Stand™ Treestands; personal injury or loss; or any other damages.

General: (a) This agreement is the entire agreement between you and X-Stand™ Treestands.; supersedes any prior or different agreements, representations, or proposals; and may be changed only by written agreement with X-Stand™ Treestands. (b) Waiver by any party of any default or breach of this agreement will not constitute a waiver of any subsequent default or breach of the same or different kind. (c) The invalidity of any provision of this agreement shall not affect the validity of the other provisions hereof. (d) This agreement shall be governed by the laws of the State of Minnesota, U.S.A. X-Stand™ Treestands; Lakeville, MN 55044

READ THIS MANUAL IN ITS ENTIRETY PRIOR TO USING THIS PRODUCT.

This instruction manual complies with ASTM F2123 Standard Practice for Treestand Instruction.

X-STAND.COM



21673 Cedar Avenue South | Lakeville, MN 55044 | 540-877-2769 | Fax: 952-236-6458

This X-Stand™ product(s) has been tested to rigid industry standards. Safe operation and use of this X-Stand™ product(s) is the responsibility of the user(s). Please read and follow all safe use instructions and warnings. Failure to follow these may result in serious injury or death!

Second Edition, March 2018, Published by X-Stand™ Treestands, Lakeville Minnesota.

© 2018 X-Stand™ Treestands. All rights reserved.