

### 2014-2018 Chevrolet & GMC Silverado/Sierra Light Duty Crew Cab and 2015-2019 Silverado/Sierra Heavy Duty Crew Cab *Underseat Storage*

*Fits DU-HA Part Numbers*

10300 10302  
10301 10303  
10307

#### Installation Instructions:

- 1 Lift up the bottoms of both sides of the back seat.
- 2 Place the large hole of Metal Straps (F) onto the threaded stud under the rear seat on top of the ledge behind the jack and jack tools, secure with 1/2" Nut – 10300 (E), as pictured, on drivers side and passenger side.
- 3 Position the DU-HA (A) under the back seat, with the cut out slots facing towards the truck bed.
- 4 Insert the Metal Strap (F) through the slot in the back of the DU-HA (A) and slide the Rectangular Washer (G) over the Metal Strap (F).
- 5 Secure each Metal Strap (F) to the DU-HA (A) using the Carabiner (D), open the Carabiner and insert through the small hole on the Metal Strap (F).
- 6 Install the Foam Organizer / Gun Rack (B) and Plastic Stiffeners (C) by sliding them into the channel slots inside the DU-HA (A), making sure the high side of each piece faces towards the front.
- 7 Lower the bottoms of both sides of the back seat to their original position.

#### Safety Instructions:

**Warning:** Seat bottom must be down at all times while vehicle is moving. Make sure the DU-HA is secured in the vehicle according to installation instructions. Do not store explosives or hazardous materials in the DU-HA. Do not place loaded guns in the DU-HA. For further instructions refer to truck owners manual or contact DU-HA, Inc.



2 shotguns or rifles, 1 with scopes, will fit in the gun rack, as pictured.

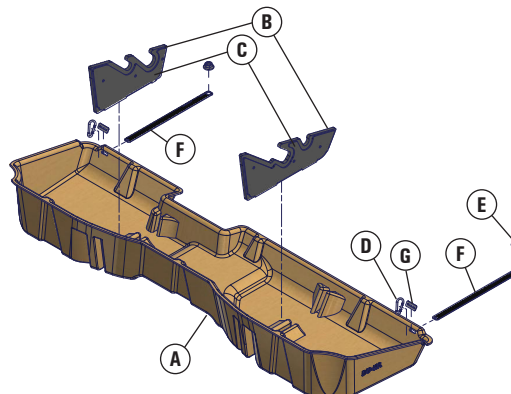

Part	Part Number	Description	Qty
A	--	DU-HA Storage Unit	1
B	Divider-10300R	Foam Organizer / Gun Rack	2
C	Divider-10300R	Plastic Stiffener	2
D	1001213	Carabiner	2
E	Nut-10300	1/2" Nut – 10300	2
F	1001162	Metal Strap	2
G	1001212	Rectangular Washer	2

