



Powersports

Model CK100-S Assembly Instructions



PLEASE NOTE THAT THIS IS NOT THE OWNER'S MANUAL BUT THE ASSEMBLY INSTRUCTIONS ONLY.

BEFORE OPERATING THIS GO-KART, MAKE SURE THE OPERATOR READS AND UNDERSTANDS THE OWNER'S MANUAL, WARNING LABELS AND IS FAMILIAR WITH ALL GO-KART CONTROLS.

FOR QUESTIONS REGARDING ASSEMBLY OF THIS GO-KART, PLEASE CALL COLEMAN POWERSPORTS, TOLL FREE 888-405-8725

colemanpowered.com

REMOVAL FROM CRATE

1. Remove metal crate from around Go-Kart.

2. Locate and Remove Owner's/Operator's manual, Set up instructions and all documentation.

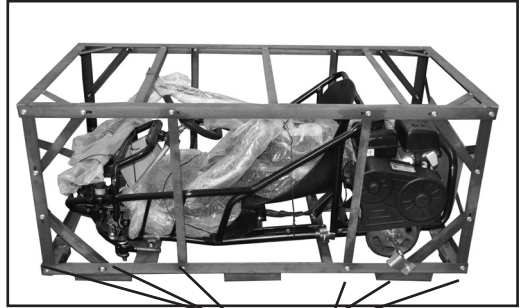

Remove bolts

Note:

Read Owner's / Operator's manual thoroughly before starting Go-Kart for the first time.

3. Locate and remove all parts and hardware from crate and set aside.

Note: Some hardware may already be mounted at part locations on the Go-Kart. This hardware will need to be removed then re-attached during assembly.

Remove bolts holding
chassis to crate

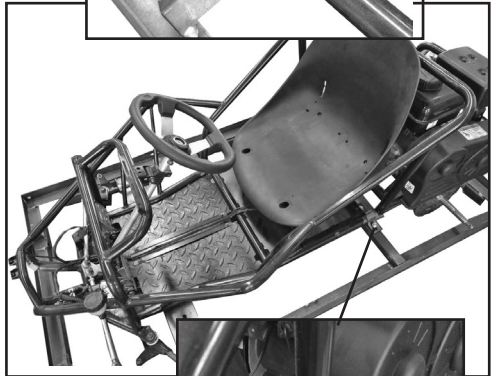
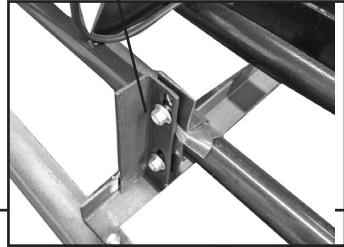

Remove bolts holding
chassis to crate

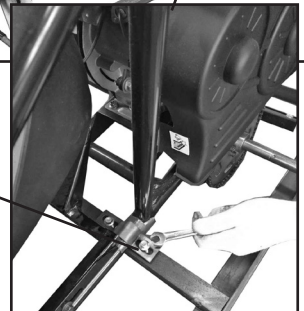

PARTS

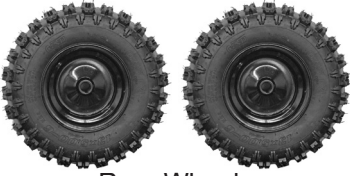

Rear Wheels



Front Wheels



Hardware



Side Panels



Nose Piece



Nose Piece
Bracket



Safety net
support



Safety Net



Pads



Tool Kit

FRONT TIE ROD ASSEMBLY

Hardware:

M8 X 30 Bolts 2ea. (A)

M8 Lock Nuts 2ea (B)



1. Locate the end of the Tie rods (C) on both sides of Go-Kart.

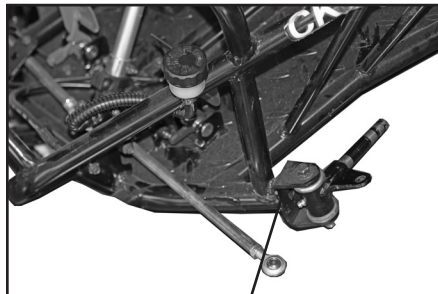

2. Attach Tie rod (C) to spindle (D) using M8 x 30 bolts (A) and M8 lock nuts (B).

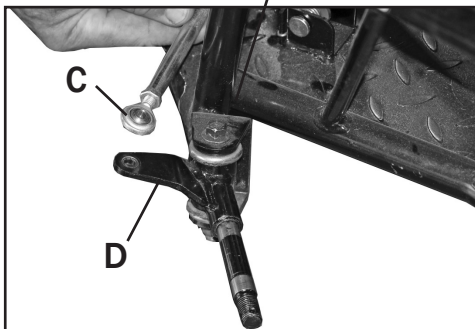

3. Cinch nuts tight.

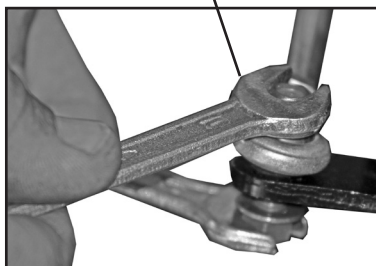
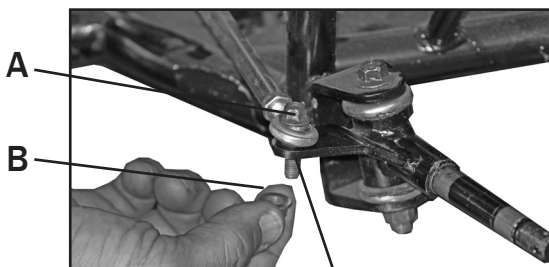

FRONT WHEEL ASSEMBLY

Hardware:

M14 Washer	2ea.	(A)
M14 Lock washer	2ea.	(B)
M14 Cap Washer	2ea.	(C)
M14 Castle nuts	2ea.	(D)
Cotter pins	2ea.	(E)
Hub Caps	2ea.	(F)

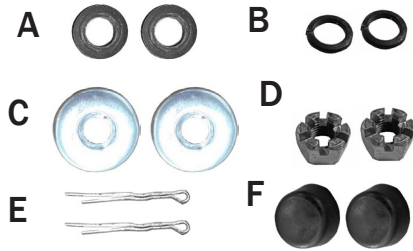

1. Install Tires on front axles making sure air stem on rim faces out.

2. Attach wheel to axle using hardware in the following order:

Washer (A)

Lock washer (B)

Large cap washer (C)

Castle Nut (D)



3. Tighten castle nut (D) snug. Do not over tighten.

4. Install cotter pin (E), make sure to bend ends over once installed.

5. Install Hub Cap (F)

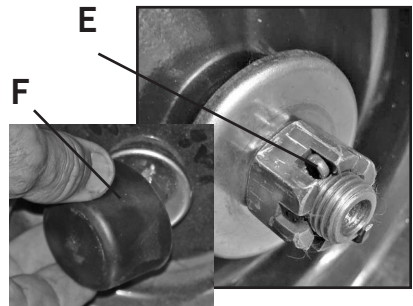
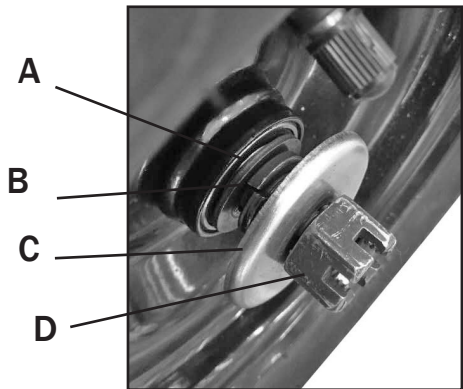

⚠ WARNING

Failing to install cotter pins could be hazardous.
Failing to install cotter pins could cause the wheel to fall off resulting in an accident.
Never operate Go Kart without cotter pins installed

REAR WHEEL ASSEMBLY

Hardware:

Wheel Spacers	2ea. (A)
Key	2ea. (B)
M14Washer	2ea. (C)
M14 Cap Washer	2ea. (D)
M14 Castle nuts	2ea. (E)
Cotter pins	2ea. (F)
Hub Caps	2ea (G)

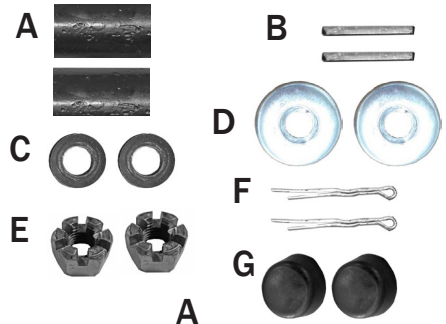

1. Slide wheel spacer (A) over axle

2. Insert Key (B) into Keyway groove on axle.

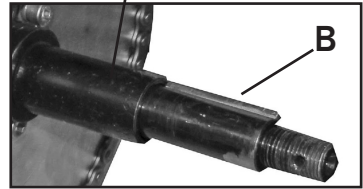

3. Install Tires on rear axle making sure air stem on rim faces out.



4. Attach wheel to axle using hardware in the following order:
Washer (C)
Large cap washer (D)
Castle Nut (E)

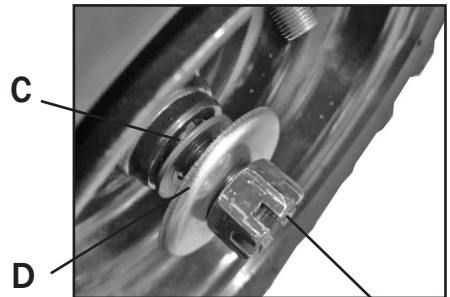

5. Tighten castle nut (E) snug. Do not over tighten.

6. Install cotter pin (F), make sure to bend ends over once installed.

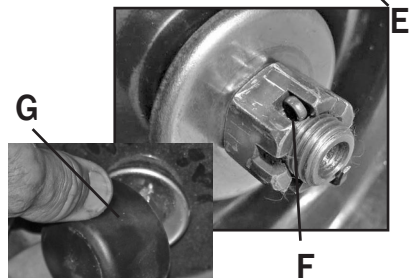

7. Install Hub cap (G)



NOSE COVER ASSEMBLY

Hardware:

M6 x 12 bolts 5ea. (A)



1. Install nose bracket (B) on frame using M6 x 12 bolts (A).

Note: Bracket should face down.

2. Install nose cover (C) and attach to Nose bracket (B) and steering column assembly using M6 x 12 Bolts (A). Tighten bolts.

3. Plug On/Off switch into wire on frame

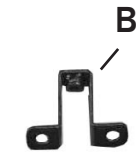
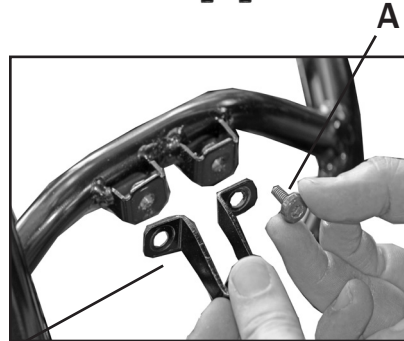

Steering Column

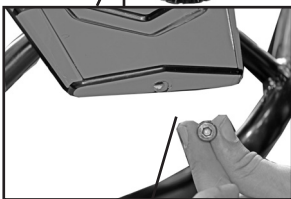
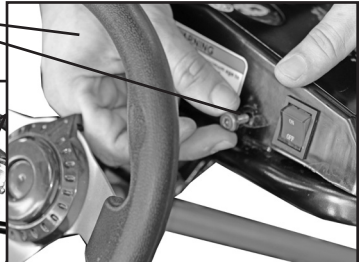
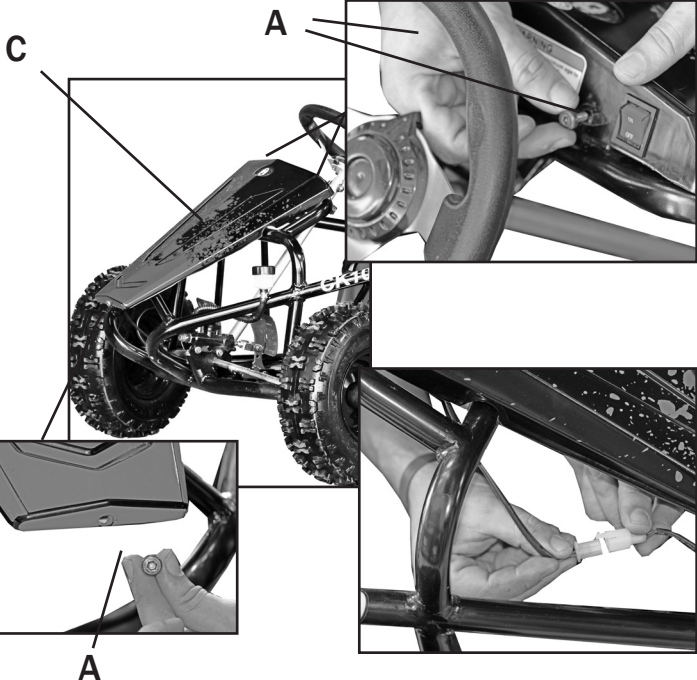
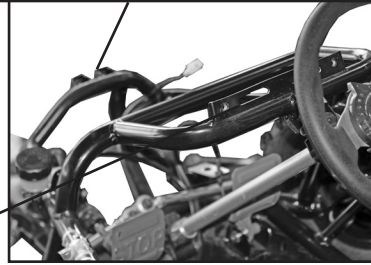

SAFETY NET ASSEMBLY INSTALLATION

M8 X 60 bolts 3 ea. (A)
M8 Concave Spacers 3 ea. (B)
M8 Flat Washers 6ea. (C)

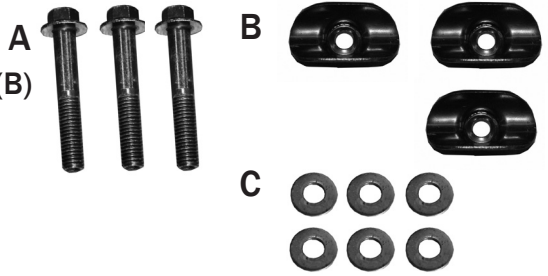

1. Attach Safety net frame to Kart with M8 bolts (A), and Concave spacers (B) M8 Thick washers (C)

2. Attach safety net (D) to frame.

3. Install Pads (E)

4. Install side panels (F) by wrapping panels edges around frame and velcro.

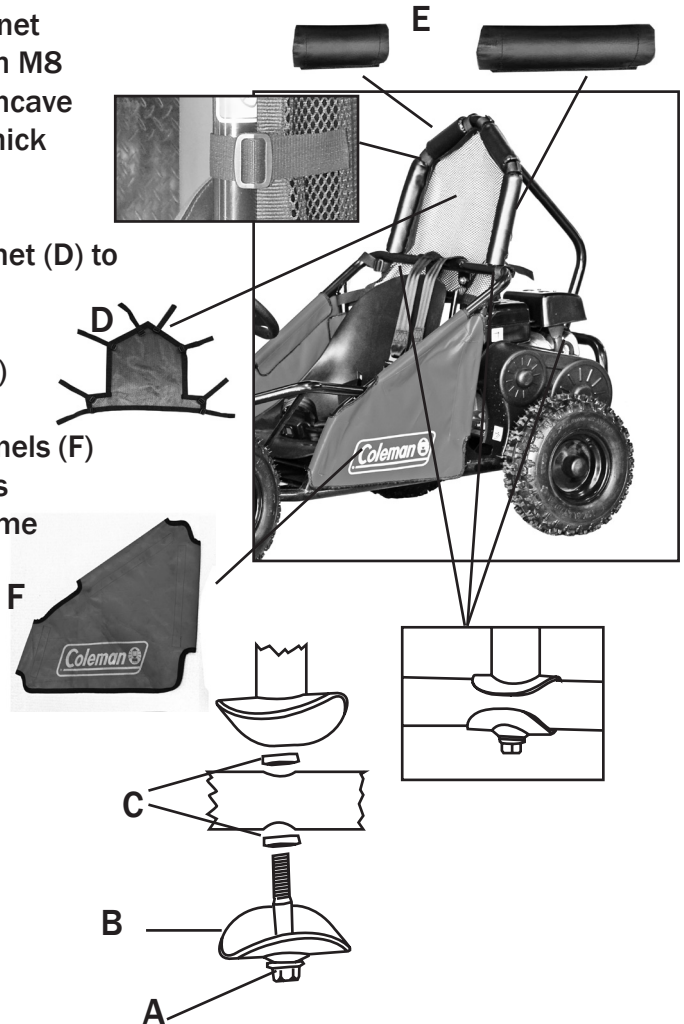

PRE-RIDE INSPECTION

Inspecting and checking the condition of the Go Kart before each ride is important. Following the pre-ride check list will help insure the you do not have mechanical problems which could result in injury or becoming stranded. Make sure the Go Kart is in good operating condition before each ride.

⚠ WARNING

Failing to inspect and maintain your Go Kart could be hazardous.

Not following the pre-ride inspection procedures could result in losing control of the Go Kart resulting in an accident or damage to the Go Kart

Always perform a Pre-ride inspection before each ride.

⚠ WARNING

Performing maintenance and checks while the engine is running could be hazardous.

You could be severely injured by moving parts or hot surfaces.

Never perform maintenance or check procedures while the engine is running with the exception of checking the ignition switch or throttle.

WHAT TO CHECK	CHECK FOR
Steering	<ul style="list-style-type: none"> • Smoothness • No restriction of movement
Brakes	<ul style="list-style-type: none"> • Stops Kart • Inspect hoses • Correct fluid level • Inspect brake pads for wear.
Tires	<ul style="list-style-type: none"> • Proper tire pressure • Proper tread depth • Rubber has no cracks
Fuel Tank	<ul style="list-style-type: none"> • Enough fuel for the ride • Fuel cap secure • Hoses have no signs of cracks or leaks
Throttle Pedal	<ul style="list-style-type: none"> • Pedal snaps back to idle when released • Operates freely
Engine Ignition switch	<ul style="list-style-type: none"> • Switch shuts off engine when activated.
Engine Oil	<ul style="list-style-type: none"> • Correct oil level
Safety Net	<ul style="list-style-type: none"> • Securely attached • Good condition
Drive Chain	<ul style="list-style-type: none"> • Proper tension • Lubricated • No excessive wear or damage
General Condition	<ul style="list-style-type: none"> • All nuts and bolts tight • No rattles from engine or frame while running • All guards attached

⚠ WARNING

Never Attempt to start this Go-Kart without reading and understanding the Owner's/Operator's manual. The Owner's/Operator's manual provides information on safety, parts, functions, pre-ride inspection, starting and maintenance.



Powersports

Phone: 888-405-8725

Colemanpowered.com