



Solar Charge Controller

Installation and Operation Manual
SCC20-40A

AIMS POWER™

Headquarters

9550 Gateway Drive

Reno, NV 89521

Telephone: (775) 359-6703

Email:

Sales@aimscorp.net

Techsupport@aimscorp.net

Contents

1. Important Safety Instructions	3
2. Getting Familiar with Display	5
3. Installation	9
4. Operation	14
5. Troubleshooting	19
6. Warranty Claim Procedure and Datasheet	20

1. Important Safety Instructions

This manual contains important safety, installation and operating instructions for the MPPT solar controller.

The following symbols are used throughout this manual to indicate potentially dangerous conditions or mark important safety instructions.



WARNING:

Indicates a potentially dangerous condition. Use extreme caution when performing this task.



CAUTION:

Indicates a critical procedure for safe and proper operation of the controller.



NOTE:

Indicates a procedure or function that is important for the safe and proper operation of the controller.

Safety Information

- Read all the instructions and cautions in the manual before beginning installation.
- There are no user serviceable parts inside the MPPT charger. Do not disassemble or attempt to repair the controller.
- Disconnect all sources of power to the controller before installing or adjusting the controller setting.
- Mount the controller indoors. Prevent exposure to the elements and do not allow water to enter the controller.
- Install the controller in a location that prevents casual contact. The controller can become very hot during operation.
- Use insulated tools when working with batteries.
- Avoid wearing jewelry during installation.
- The battery bank must be comprised of batteries of same type, make and age.
- Do not smoke near the battery bank.

- Power connections must remain tight to avoid excessive heating from a loose connection.
- Use properly sized conductors and circuit interrupters.



WARNING: A battery can present a risk of electrical shock or burn from large amounts of short-circuit current, fire, or explosion from vented gases. Observe proper precautions.



CAUTION: When replacing batteries, use properly specified sizes, type and rating based on application and system design.

About this Manual

This manual provides detailed installation and usage instructions for the MPPT solar charge controller. Only qualified electricians and technicians who are familiar with solar system design and wiring practices should install the MPPT controller. The usage information in this manual is intended for the system owner/operator.

2. Getting Familiar with Display

Monitoring

Function Keys

Function Key	Description
BACK / LEFT	To exit setting mode
UP	To go to previous selection
DOWN	To go to next selection
ENTER / RIGHT	To confirm the selection in setting mode or enter setting
ON(RIGHT)/OFF(LEFT)	Press for 2 seconds it will turn on/off the DC load

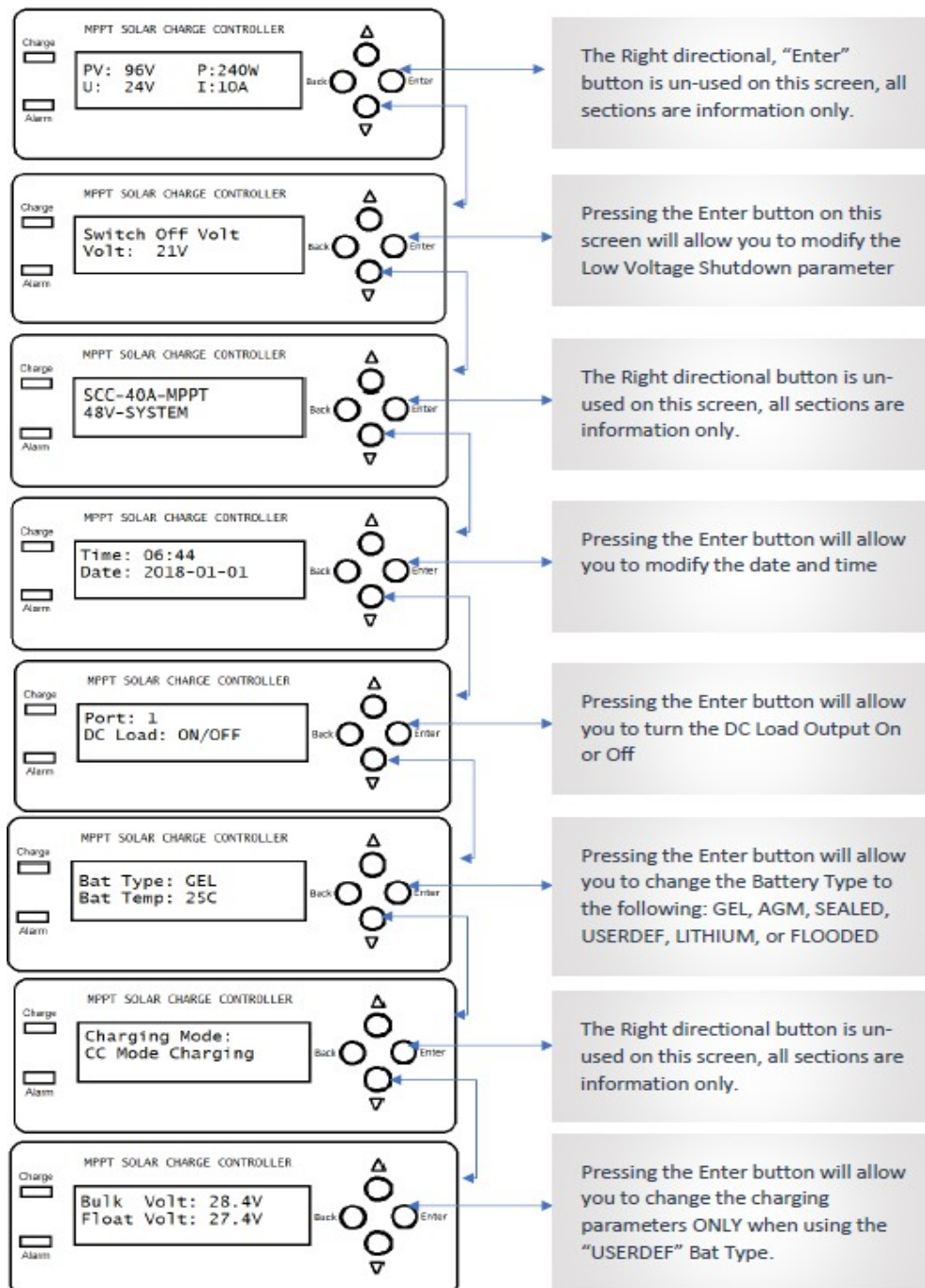

Overview

The MPPT controller is an advanced maximum power point tracking solar battery charger. The controller features a smart tracking algorithm that finds and maintains operation at the solar array's peak power point, maximizing energy harvest.

The MPPT controller charging process has been optimized to prolong battery life and improve system performance. Self-diagnostics and electronic error protections prevent damage when installation errors or system faults occur. The controller also features four adjustable setting switches, RS485 communication port (40A only) and terminal for remote battery temperature monitoring.

Please take the time to read this operator's manual and become familiar with the controller. This will help you utilize the many advantages of the MPPT Controller for your PV system.

Versions and Rating

Model	Rated Current	Solar Input Voc	System voltage	DC Load	Cooling type	Casing
SCC-20A MPPT	20A	18~100Vdc	12V/24V	30A	Heatsink	Metal casing
SCC-30A MPPT	30A	18~100Vdc	12V/24V	30A	Heatsink	Metal casing
SCC-40A MPPT	40A	18~150Vdc	12V/24V/36V/48V	40A	Heatsink	Metal casing
SCC-60A MPPT	60A	18~150Vdc	12V/24V/36V/48V	60A	Heatsink	Metal casing
SCC-80A MPPT	80A	18~150Vdc	12V/24V/36V/48V	60A	Heatsink	Metal casing
SCC-100A MPPT	100A	18~150Vdc	12V/24V/36V/48V	60A	Heatsink	Metal casing

Features

The features of the MPPT controller are shown in figure below. An explanation of each feature is provided.

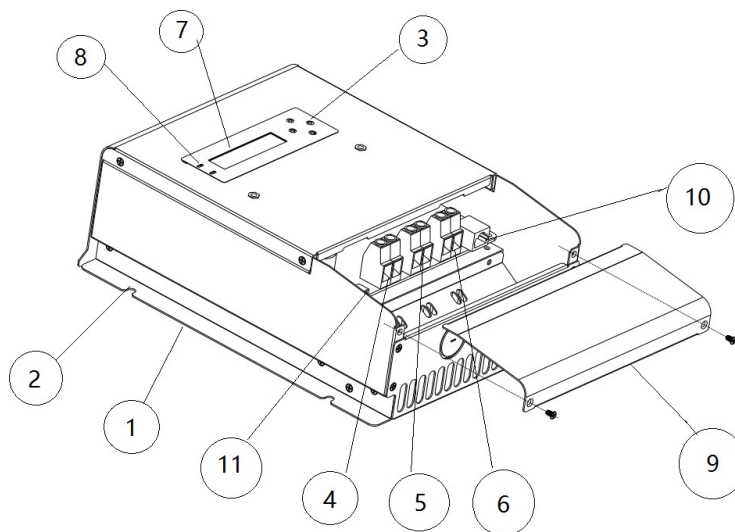

1. Heatsink

Aluminum heatsink to dissipate controller heat

2. Mounting hole

Predrilled slot for mounting

3. Setting switches

Four setting switches to configure operation of the MPPT controller

4. Solar positive terminal

Power connection for solar (+) Solar

negative terminal Power connection for

solar (-)

1. Battery outputs. Positive port to connect to positive battery terminal (+). Negative port to

connect to negative battery (-) terminal.

2. DC load output

3. LCD screen

Indicate the operating status

4. LED indicators

LED indicators show charging status and controller faults

5. Wiring box cover

Box cover to protect power connections

6. Battery temperature sensor

Terminal for battery temperature sensor. Controls charge current if battery is too hot.

7. RS-485 Port (40 amp only)

Terminal for RS-485 communication

40 AMP

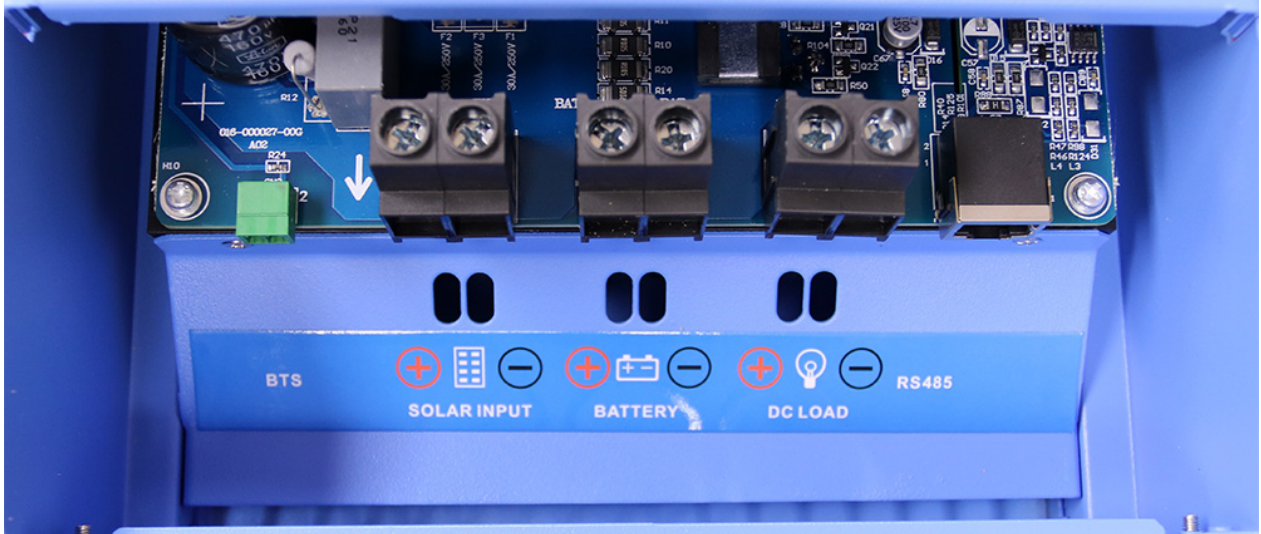

30 AMP

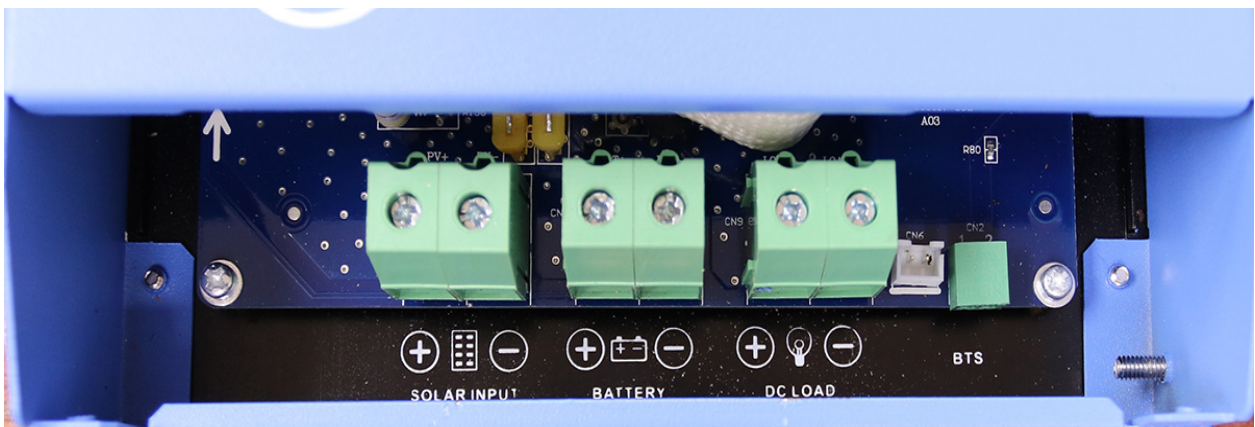

3. Installation

General Information

The mounting location is important to the performance and operating life of the controller. The environment must be dry and protected from water sources. If required, the controller may be installed in a ventilated enclosure with sufficient air flow. Never install the controller in a sealed enclosure. The controller may be mounted in an enclosure with sealed batteries, but **never with vented/flooded** batteries. Battery fumes from vented batteries will corrode and destroy the controller's circuits.

Multiple controllers can be installed in parallel to the same battery bank to achieve higher charging current. Additional controllers, connected in parallel, may be added in the future. Each controller must have its own solar array and size the same.



CAUTION: Equipment Damage or Risk of Explosion

Never install the controller in an enclosure with vented/flooded batteries. Battery fumes are flammable and will corrode and destroy the controller circuits.



CAUTION: Equipment Damage

When installing the controller in an enclosure, ensure proper ventilation. Installation in a sealed enclosure will lead to over-heating and lessen controller's overall life.

The installation is straight-forward, but it is important each step is done correctly and safely. A mistake can lead to dangerous voltage and current levels. Be sure to carefully follow each instruction. Read all instructions first before beginning installation.

Recommended Tools:

- Wire strippers
- Wire cutters
- Phillips screwdriver
- Slotted screwdrivers
- Pliers
- Drill
- Drill bit
- Level
- Hacksaw (cutting conduit)

Controller Installation

Step 1-Remove the wiring box cover to access inside of charge controller.

Step 2 – Punch out perforated hole slots to feed cables through bottom of charge controller.



CAUTION: Shock Hazard

Disconnect all power sources to the controller before removing the wiring box cover. Never remove the cover when voltage exists on any of the power connections.

Use a #4 Phillips screw driver to remove the screws that secure the wiring box cover as show in figure below.

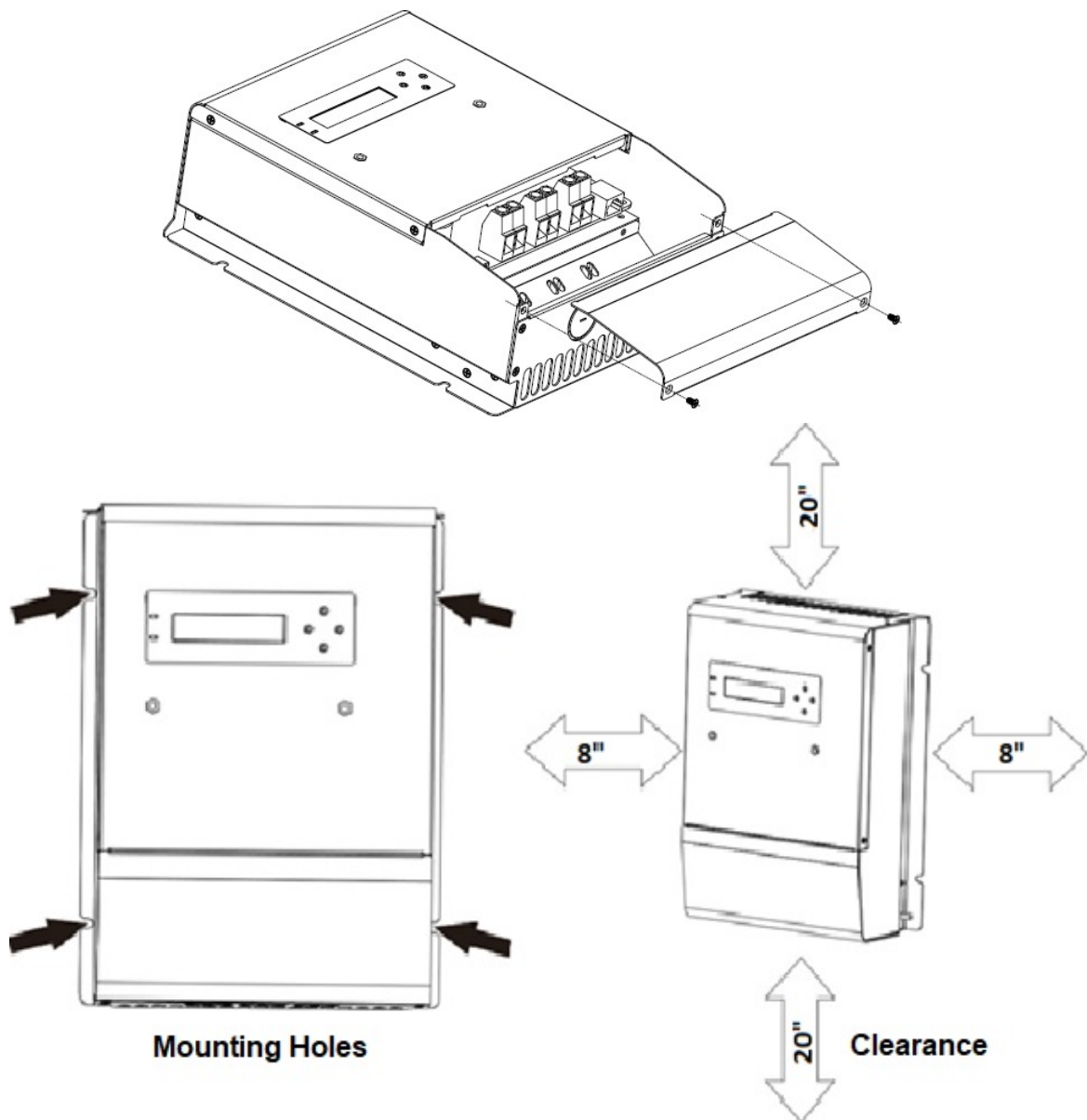

Power Connections

The six large power terminals are sized for up to 6 AWG wire. The terminals are rated for copper and aluminum conductors. Good system design generally requires large conductor wires for the solar and battery connection that limit voltage drop losses to 2% or less.

Minimum Wire Size

The wire recommendation below is based on an ambient temperature of 113° F or 45° C. Adjust cable size for more extreme temperatures.

Model	Copper Wire Type	Recommended Size	Minimum Size
20A	Copper	12AWG	14AWG
30A	Copper	10AWG	12AWG
40A	Copper	6AWG	8AWG
60A	Copper	5AWG	6AWG
80A	Copper	4AWG	5AWG
100A	Copper	4AWG	5AWG



WARNING: Shock Hazard

The solar PV array cannot produce open-circuit voltages exceeding 100V DC when in sunlight. If using breakers or disconnect switches, verify that the solar input breaker or disconnect switch has been opened (disconnected) before installing the system wires.



BTS Sensor

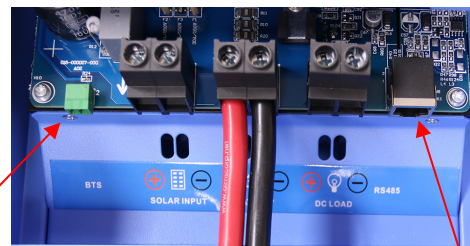

RS485 Port

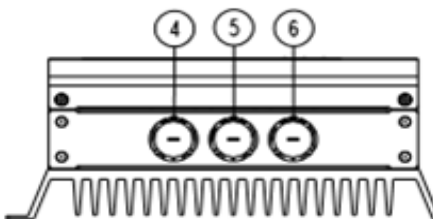

Model: 30A

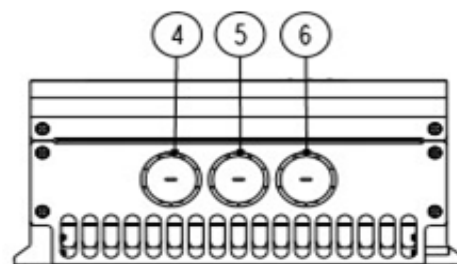

Model: 40A

1. Insert the wires through the bottom of the charge controller via the punch out holes.

④ Solar Input ⑤ Battery Input ⑥ DC Load Output (#6 is not required)

If using input and output disconnect switches or breakers, ensure they are turned off before connecting the power wires to the controller.



WARNING: Risk of Damage

Do not reverse the polarity on the connections. If using a breaker or disconnect switch, turn on the battery breaker or disconnect switch to ensure correct polarity and voltage with a multi meter BEFORE connecting to charge controller. Final connection should be made with breakers in the off position.

2. Connect the **battery+ (Positive)** wire to the **battery+** terminal on the controller, Connect the **battery- (Negative)** wire to the **battery-** terminal on the controller.
3. Connect the **Solar+ (Positive)** wire to the **PV+** terminal on the controller, Connect the **Solar- (Negative)** wire to the **PV-** terminal on the controller.
4. Connect the **DC load+ (Positive)** wire to the **Load+** terminal on the controller, Connect the **DC load- (Negative)** wire to the **Load -** terminal on the controller.
5. If using the battery temperature sensor, connect sensor. Attach the battery temp sensor to the side of the battery (s) closest to the charge controller, near the negative terminal.
6. If using RS485 monitoring, connect a RS485 cable (only available on 40amp).

****NOTE – Do not connect the battery (s) to the DC load port. Only connect battery (s) to the “Battery Port”.***

Powering Up



WARNING: Risk of Damage

Connecting the solar array to the battery terminal will **permanently damage** the controller.



WARNING: Risk of Damage

Connecting the solar array or battery connection with reverse polarity will **permanently damage** the controller.

- Confirm that the Solar and Battery polarities are correct.
- Turn the battery disconnect switch on first (if using one). Ensure the LCD screen powers on.
- Note that a battery bank must be connected to the controller to start and operate the controller. The controller will not operate from solar input only.
- Turn the solar disconnect switch on (if using one). If the solar array is in full sunlight. The controller will begin charging.

Powering Down



WARNING: Risk of Damage

Only disconnect the battery from the controller **AFTER** the solar input has been disconnected. Damage to the controller may result if the battery is removed while the controller is charging.

To prevent damage, power-down must be done in the reverse order as power-up.

4. Operation

The MPPT controller is fully automatic. After installation is completed, there are few operator tasks to perform. However, the operator should be familiar with the operation and care of the controller as described in this section.

The MPPT controller utilizes Solar Maximum Power Point Technology

Tracking (MPPT) technology to extract maximum power from the solar array. The tracking algorithm is fully automatic and does not require user adjustment. MPPT technology tracks the array maximum power point as it varies with weather conditions, ensuring that maximum power is harvested from the array throughout the course of the day.

Current Boost

Under most conditions, MPPT technology will “boost” the solar charge current. For example, a system may have 36 Amps of solar current flowing into the controller and 44 Amps of charge current flowing out to the battery. The controller does not create current! Rest assured that the power into the controller is the same as the power out of the controller. Since power is the product of voltage and current (Volts x Amps), the following is true*:

(1) Power into the MPPT 100V = Power Out of the MPPT 100V

(2) Volts In x Amps In = Volts Out x Amps Out

* Assuming 100% efficiency. Losses in wiring and conversion exist.

If the solar module's *maximum power voltage* (V_{mp}) is greater than the battery voltage, it follows that the battery current must be proportionally greater than the solar input current so that input and output power are balanced. The greater the difference between the V_{mp} and battery voltage, the greater the current boost. Current boost can be substantial in systems where the solar array is of a higher nominal voltage than the battery as described in the next section.

Battery Charging Information

The MPPT controller has 4-stage battery charging algorithm for rapid, efficient, and safe battery charging. Figure 4-1 shows the sequence of the stages.

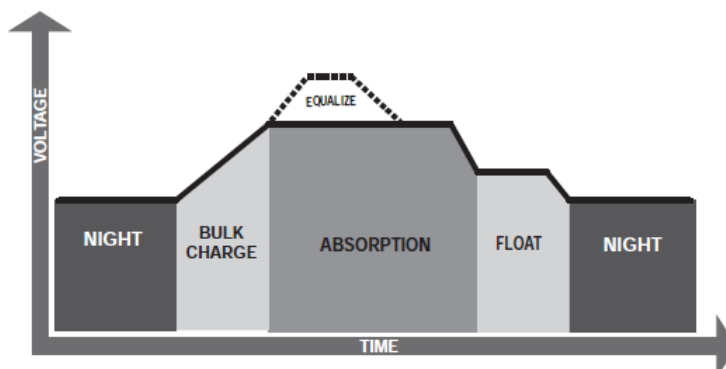

Figure4-1. MPPT Controller Charging Algorithm

Battery Charging Settings

Battery type	Bulk charge stage	Absorption charge stage	Float charge stage
Gel	14.2	14.4	13.7
AGM	14.3	14.5	13.7
Sealed	14.4	14.6	13.7
Flooded	14.6	14.8	13.5
Lithium/Lifepo4	13.7-15	Same as bulk charge voltage-	Same as bulk charge voltage
User define	10.0-15V	10.0-15V	10.0-15

It is important to select the correct battery setting for the battery type used in the solar system. Refer to the specifications provided by the battery manufacturer and choose a setting that best fits the recommended charging profile.

There are 3 charging stages:

Bulk Charging: This is the initial stage of charging. While Bulk Charging, the charger supplies the battery with controlled constant current. The charger will remain in Bulk charge until the Absorption charge voltage (determined by the Battery Type selection) is achieved. The green LED will blink once every 0.5 seconds during bulk charging.

Absorb Charging: This is the second charging stage and begins after the battery has recharged to the set absorption voltage. Absorb Charging provides the batteries with a constant voltage and reduces the DC charging current, maintaining the absorb voltage setting. This prevents heating and excessive battery gassing. The green/blue Led will blink once per every two seconds during absorption charging.

Float Charging: The third charging stage occurs at the end of the Absorb Charging time. While Float Charging, the charge voltage is reduced to the float charge voltage (determined by the Battery Type selection). In this stage, the batteries are kept fully charged. The float stage provides a very low rate of maintenance charging while reducing the heating and gassing of a fully charger battery. This protects the battery from long term over charger. The green/blue LED will keep green during float charging

Network Connections

Network connections allow the MPPT controller to communicate with computers. A network can be as simple as one controller and one PC, or as complex as dozens of controllers monitored via the Internet. RS485 cable needed and not included. Available on AIMS Power charge controllers 40, 60, 80 and 100 amp models.

WARNING: Risk of Explosion

Equalizing vented batteries produce explosive gases. The battery bank must be properly ventilated.



CAUTION: Equipment Damage

Equalization increases the battery voltage to levels that may damage sensitive DC

loads. Verify all system loads are rated for the temperature compensated Equalize voltage before beginning an Equalization charge. Excessive overcharging and gassing too vigorously can damage the battery plates and cause shedding of active material from the plates. An equalization that is too high or for too long can be damaging. Review the requirements for the battery being used in your system.

Temperature Compensation

All charging settings are based on 25°C (77°F). If the battery temperature varies by 5°C, the charging setting will change by 0.15 volts from a 12V battery. This is a substantial change in the charging of the battery, and the use of the battery sensor is recommended to adjust charging to the actual battery temperature.

Protections, Faults and Alarms

The MPPT controller protections and automatic recovery are important features that ensure the safe operation of the system. Additionally, the controller features real-time self-diagnostics that report Fault and Alarm conditions as they occur.

Faults are events or conditions that require the controller to cease operation. A Fault usually occurs when a limit such as voltage, current, or temperature has been surpassed. Fault conditions are indicated with unique LED sequences and are also displayed on the LCD screen.

-Solar overload

The controller will limit battery current to the maximum battery current rating. An oversized solar array will not operate at peak power. The solar array should be less than the controller nominal maximum input power rating for optimal performance.

-Solar short circuit

The controller will disconnect the solar input if a short circuit is detected in the solar wiring. Charging automatically resumes when the short is cleared.

-Very Low battery Voltage

If battery discharge below 9Volts the controller will go into brownout and shut down. When the battery voltage rises above the 10 Volts minimum operating voltage, the controller will restart.

-High temperature current limit

The MPPT controller will limit the solar input current if the heatsink temperature exceeds safe temperature. Solar charge current will be tapered back (to 0 amps if needed) to reduce the heatsink temperature. The controller is designed to operate at full rated current at the maximum ambient temperature. This alarm indicates that there is insufficient airflow and that the heatsink temperature is approaching unsafe limits. If the controller frequently reports this alarm condition, corrective action must be taken to provide better air flow or to relocate the controller to a cooler spot.

-High Input voltage current limit

The MPPT controller will limit the solar input current as the solar array Voc approaches the maximum input voltage rating. **The array Voc should never exceed the maximum input voltage (100VDC).**

Current Limit

The array power exceeds the rating of the controller, this alarm indicates that the controller is limiting battery current to the maximum current rating.

Uncalibrated

The controller was not factory calibrated. Return the controller to an authorized dealer for service.

Inspection and Maintenance

The following inspections are recommended two times per year for best long-term performance.

System Inspection

- Confirm the controller is securely mounted in a clean and dry environment.
- Confirm that the air flow around the controller is not blocked. Clean the heatsink of any dirt or debris.
- Inspect all exposed conductors for insulation damage due to sun damage, rubbing on nearby objects, dry rot, insects, or rodents. Repair or replace conductors as necessary.
- Tighten all power connections per the manufacturers' recommendations.
- Verify the LED and LCD indications are consistent with the equipment operation. Note any fault or error indications. Take corrective action if necessary.
- Inspect the battery bank. Look for cracked or bulging cases and corroded terminals.
- Inspect the system earth grounding for all components. Confirm all grounding conductors are appropriately secured to earth ground.

Inside the MPPT Controller Wiring Box



CAUTION: Shock Hazard

Disconnect all power sources to the controller before removing the wiring box cover. Never remove the cover when voltage exists on the controller power connections.

- Check all wire terminals. Inspect connection for corrosion, damaged insulation, signs of high temperature or burning/discoloration. Tighten the terminal screws to the recommended torque.
- Inspect for dirt, nesting insects, and corrosion. Clean as required.

5.Troubleshooting

Battery Charging and Performance Issues

Problem: No LCD or LED indications, controller does not appear to have power.

Solution:

With a multi-meter, check the voltage at the battery terminals on the controller. Battery voltage must be 9 VDC or greater. If the voltage on the battery terminals of the controller is between 9 and 60 VDC and no LED or LCD indicate, contact your authorized dealer for service. If no voltage is measured, check wiring connections, fuses

Problem:

The controller is not charging the battery.

Solution:

If the LCD indicator is normal, check the fuses, breakers and wiring connections in the solar array wiring. With a multi-meter, check the array voltage directly at the controller solar input terminals. Input voltage must be greater than the minimum start- up voltage before charging will begin.

Network and Communication Issues.

Problem:

Cannot connect to the controller via communication port.(only available on 40 amp)

6.1 Communication port pinout

Make sure that your cable matches the RS485 communication port. The communication port is RS485.

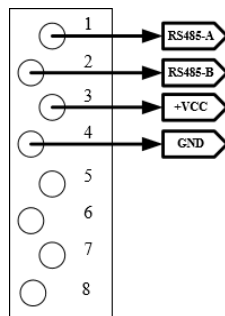

6. Warranty Claim Procedure and Datasheet

All AIMS Power™ products come with warranty coverage against defects as follows, from the date of purchase, unless otherwise indicated:

- 2-Years for ETL (Extract, Transform and Load) Solar Charge Controllers

Within the warranty coverage period, AIMS Power™ will either repair or replace, at its sole discretion, the defective product.

Any shipping charges that occur as a result of a warranty return or exchange are NOT covered by the warranty and are the responsibility of the customer.

The warranty **does not cover** the following:

- Products that AIMS Power™ determine, in its sole discretion, to be free of any material or workmanship defects or flaws
- Products evidencing excessive wear, misuse or alteration
- Products with missing or defaced labels, stickers, or other identifying information
- Improper care or storage (e.g. water damage, exposure to extreme heat or cold temperatures, unsanitary environment)
- Alterations or customizations
- Items that were purchased second hand, or from an unauthorized seller
- Items outside of the covered warranty period

TO RETURN MERCHANDISE: It is our goal at AIMS Power™ to provide a comprehensive and hassle-free return and exchange process. As such, please review the below process before initiating warranty claim.

1. Contact AIMS Power™ via phone or email to submit your warranty return request and obtain a Return Merchandise Authorization (RMA) number.

Note: Be sure to provide the name from the original order as well as the original order number.

2. An automated email will then be sent to the address indicated on the warranty return request containing further instructions regarding packing, shipping and documentation to include when returning the product as well as an RMA authorization number.
3. Once the return is received and inspected an e-mail will be sent informing you that the return has been approved and processed. If there are any issues with the return, an additional e-mail will be sent notifying you of such.

Other Items of note:

- AIMS Power™ DOES NOT cover return shipping. Any Product that is returned and deemed to be of working condition or was returned without all of the required information, and the customer has not paid for return shipping, may be disposed of or destroyed after 90 days.
- Any requested information that is not provided in a timely manner could result in delayed processing of your return.

- When shipping the product for a return:
 - Ensure the product is packed accordingly to avoid being damaged in-transit. Include original packaging. Use proper protective material to ensure package arrives without damage.
 - Ensure some form of shipment tracking is used.
 - It is strongly recommended to insure the shipment.
 - AIMS Power™ is not liable for products that are lost or damaged in-transit.
- The RMA authorization email will indicate what, if any, other product contents need to be sent in with the returned product.
- For any other questions please contact us via phone or email.

Except as provided above, AIMS makes no warranty of any kind, express or implied, including without limitation the implied warranties of merchantability and fitness for a particular purpose. In no event shall AIMS be liable for indirect, special or consequential damages. This warranty only applies to AIMS Power branded products. All other name brand products are warranted by and according to their respective manufacturer. Please do not attempt to return non-AIMS Power branded products to AIMS Power.

For additional products such as:

- Modified Sine Wave Inverters
- Pure Sine Wave Inverters
- Low Frequency Inverters
- Solar Charge Controllers
- Inverter Chargers and Automatic Transfer Switches
- Converters AC-DC and DC-DC
- Custom Cut Cables
- Batteries
- Solar Panels & Racks

Please visit our web site: www.aimscorp.net

To find out where to buy any of our products, you may also e-mail: sales@aimscorp.net or call (775)359-6703

SPECIFICATION	SCC20A	SCC30	SCC40	SCC60	SCC80	SCC100
Solar System Voltage	12V/24V		12V/24V/36V/48V			
Electrical						
PV operating voltage	18~100Vdc@12V 34~100Vdc@24V		15~155Vdc@12V 34~155Vdc@24V 50~155Vdc@36V 60~155Vdc@48V			
Max. PV open circuit voltage	100Vdc		155Vdc			
Rated PV input	12V 400W 24V 800W		12V 500W 24V 1000W 36V 1500W 48V 2000W	12V 800W 24V 1700W 36V 2400W 48V 3400W	12V 1200W 24V 2400W 36V 3600W 48V 4800W	12V 1400W 24V 2800W 36V 4200W 48V 5600W
Max. charging current	20A	30A	40A	60A	80A	100A
Max. DC load current	30A		40A	60A		
Self-Consumption	<2W			<4W		
Conversion Efficiency	97%	97%	97.5%	98%	98.5%	
Protection	Overload, short circuit, high voltage, high temperature protection					
Battery Charging						
Battery Type	Gel, Sealed, AGM, Flooded, Lithium, User define					
Charging Algorithm	3-stage: Bulk, Absorption, Float			4-stage: Bulk, Absorption, Float, Equalize		
Bulk charge voltage	Sealed:14.4V AGM Gel:14.2V Flooded:14.6V User define:10-15V					
Float charge voltage	Sealed/Gel/AMG:13.7V Flooded:13.6V User define :10-15V					
Equalize charge voltage	Sealed:14.6V AGM:14.8V Flooded:14.8V User define :10-15V					
Low voltage reconnect voltage	12.5V					
Low voltage disconnect voltage	10.5V (10.5~12.5 Adjustable)					
Temperature compensation	-5mV/°C /2V with BTS(Optional)					
Communication						
Communication Port	NONE			RS485		
Mechanical						
Net weight	4.7 lb	4.7lb	9 lb	17 lb	20 lb	21 lb
Gross weight	6 lb	6 lb	12 lb	21 lb	24 lb	26 lb
Dimensions	8.25x7.5x3.25"	8.25x7.5x3.2"	11x8.25x3.75"	14.5x10.5x4.5"	17x10.5x5"	18.25x10.5x5"
Packing box	13x13x4.5"	13x13x4.5"	18x12x6"	23x16x9"	23x16x9"	23x16x9"
Cooling	Heatsink cooling					
Enclosure	IP43					
Environment						
Ambient Temperature	-25~60°C (Derating from 45°C) -11°F to 140°F					
Storage Temperature	-40°C~+80°C -140 F to 176 F					
Humidity	100% non-condensing					
Warranty	Two Year					