



Operation Manual



Congratulations on purchasing your high quality AIMS Power pure sine inverter!

It is very important that you read and understand this instruction manual completely prior to use.
Contained are important connection tips, safety issues, and warranty information

❖ Contents

- Pg. 03 Specifications (5000W / 8000W-12V, 24V and 48V DC)
-
- Pg. 04 Specifications (2000W / 3000W-12V, 24V and 48V DC)
-
- Pg. 05 Features and benefits
-
- Pg. 06 Use of DC battery / Use of 120V AC power
-
- Pg. 07 Input and Output connections
-
- Pg. 08 Sketch of DC input connections / Sketch of 120V AC output connections
-
- Pg. 09 Operating procedure
-
- Pg. 10 Each section and name
-
- Pg. 11 Explanation for each section
-
- Pg. 12 Explanation for each section
-
- Pg. 13 Troubleshooting
-
- Pg. 14 General problems
-
- Pg. 15 Warnings and warranty information
-
- Pg. 16 Warranty card
-

❖ Specifications (5000W / 8000W-DC12V, 24V, 48V 120V AC)

NO.	PARAMETER	PWRIG500012120S	PWRIG500024120S	PWRIG500048120S	PWRIG800012120S	PWRIG800024120S	PWRIG800048120S
1	DC input voltage	12V(10.5V~16V)	24V(21V~31V)	48V(41V~60V)	12V(10.5V~16V)	24V(21V~31V)	48V(41V~60V)
2	Output voltage	120V AC					
3	Output power continuous	5000 watts			8000 watts		
4	Surge rating	10K watts			16K watts		
5	Efficiency(output)	90%±3%					
6	No load current	1.40A	0.90A	0.60A	2.48A	1.30A	0.65A
	fan off	2.70A	1.47A	1.08A	3.98A	2.50A	1.25A
7	Low battery shut down	10.2V	20.0V	40.2V	10.2V	20.0V	41.4V
8	Low voltage recovery	11.2V	22.4V	42.5V	11.2V	22.4V	43.7V
9	High battery shut down	17.2V	31.7V	62.9V	17.2V	31.7V	62.7V
10	High voltage recovery	15.2V	29.5V	58.8V	15.2V	30.0V	60.2V
11	Frequency selection	50hz/60hz selectable					
12	Over temperature protection	-4°F~+172°F(±41°F)					
13	Over temperature recovery	136°F(±41°F)					
14	Output wave form	Pure sine wave (Digitalized signal processor)					
15	Thermal Cooling fan	104°F(±41°F)					
16	Isolation transformer tested (withstand voltage)	2KV~2.5KV(±0.5KV)					
17	input sensor	Included					
	input fuse	40A(14EA)	40A(8EA)	30A(6EA)	40A(20EA)	40A(10EA)	40A(6EA)
	output sensor	Included					
	output circuit breaker	60A High Speed			90A High Speed		
	GFCI outlet / terminal	Included(terminal 60A-3p)					
18	Applied standards	FCC part 15 sub part B class A					
19	Dimensions (Inch)	8.9X6.2X21.3			8.9X6.2X25.6		
20	Weight (LBS.)	26lbs			33lbs		
21	Recommended battery cables	4AWT or larger	1AWT or larger	4AWG or larger	2set 4AWT or larger	4AWT or larger	1AWT or larger

► For Use With

Precision test devices, precision medical devices, precision video/audio devices, mercury lamps/halogen/H.Q.I. etc, nonlinear load (motor/coil etc)
 Other electric and electronic devices that might not work using inferior sine wave products

❖ Specifications (2000W / 3000W-DC12V, 24V, 48V 120V AC)

NO.	PARAMETER	PWRIG200012120S	PWRIG200024120S	PWRIG200048120S	PWRIG300012120S	PWRIG300024120S	PWRIG300048120S	
1	DC input voltage	12V(10.5V~16V)	24V(21V~31V)	48V(41V~61V)	12V(10.5V~16V)	24V(21V~31V)	48V(41V~61V)	
2	Output voltage	120V AC						
3	Output power continuous	2000 watts			3000 watts			
4	Surge rating	4000 watts			6000 watts			
5	Efficiency(output)	90%±3%						
6	No load current	fan off	0.7A	0.38A	0.25A	0.9A	0.42A	0.32A
		fan on	1.05A	0.54A	0.36A	1.37A	0.63A	0.83A
7	Low battery shut down	10.0V	20.0V	40.5V	10.0V	20.0V	40.5V	
8	Low voltage recovery	11.2V	22.2V	43.0V	11.2V	22.2V	43.0V	
9	High battery shut down	17.0V	31.5V	62.7V	17.0V	31.5V	62.7V	
10	High voltage recovery	14.5V	29.5V	59.0V	14.5V	29.5V	60.2V	
11	Frequency selection	50hz/60hz selectable						
12	Over temperature protection	-4°F~+172°F(±41°F)						
13	Over temperature recovery	136°F(±41°F)						
14	Output wave form	Pure sine wave (Digitalized signal processor)						
15	Thermal Cooling fan	113°F(±41°F)						
16	Isolation transformer tested (withstand voltage)	2KV~2.5KV(±0.5KV)						
17	Overload protection	input sensor	Included					
		input fuse	40A(6EA)	40A(3EA)	30A(2EA)	40A(8EA)	40A(4EA)	40A(2EA)
		output sensor	Included					
		output circuit breaker	25A High Speed			34A High Speed		
		GFCI outlet / terminal	Included(terminal 30A-3p)					
18	Applied standards	FCC part 15 sub part B class A						
19	Dimensions (Inch)	8.9X3.5X16.5			8.9X3.5X20.5			
20	Weight (LBS.)	12.2lbs			16lbs			
21	Recommended battery cables	2AWG or larger	6AWG or larger	8AWG or larger	2AWG or larger	4AWG or larger	6AWG or larger	

► For Use With

Precision test devices, precision medical devices, precision video/audio devices, mercury lamps/halogen/H.Q.I. etc, nonlinear load (motor/coil etc)
 Other electric and electronic devices that might not work using inferior sine wave products

Features and benefits

- By using a D.S.P. (DIGITAL Signal Processor) driver this inverter can safely generate its pure sine wave at a high quality 120V AC output.
- The product responds to the high and low battery voltage changes and adapts its output perfectly to ensure a stable 120V AC.
- The innovative technology of this pure sine wave inverter will support the usage of sensitive loads.



Noti - This equipment has been tested and found to comply with the limits for a Class A digital device, pursuant to part 15 of the FCC Rules. These limits are designed to provide reasonable protection against harmful interference when the equipment is operated in a commercial environment. This equipment generates, uses, and can radiate radio frequency energy and, if not installed and used in accordance with the instruction manual, may cause harmful interference to radio communications. Operation of this equipment in a residential area is likely to cause harmful interference in which case the user will be required to correct the interference at his own expense.

Features and benefits

- All DC to AC operations are automatically controlled by the D.S.P. program.
- The improved efficiency of this inverter ensures nominal output voltage even at low input DC voltage.
- Since output voltage is within 3% of the variation input voltage (12V, 24V AND 48V) stable power will always be produced for your AC loads.
- This product has excellent driving power with a surge output that's 2 times higher than the output capacity. This allows you to exceed the inverters listed output for a short period of time (500 milliseconds) to power some devices with quick startup surges.
- With various protection circuits built in, this product will automatically shut down at low voltage or in the event of a sudden change of input/output power. The inverter also shows excellent performance and reliability control during rapid environmental changes such as ambient temperature.
- **This inverter is designed with the most advanced circuitry available in order to suppress most RF noise produced by inverting DC voltage to 120V AC.**

❖ Reference

This product is a Digital Signal Processed inverter that utilizes DC 12V, 24V, or 48V to generate the 120V AC power. When the 120V AC pure sine wave inverter is properly used within the capacity listed on various electronic devices. Please follow all connection instructions to avoid damage or injury to the inverter and yourself. Failure to follow the warning messages and to connect the inverter properly will cause malfunction of the inverter and may void the warranty.

❖ Prior to using this product please read this operation manual thoroughly. Inappropriate use may cause damage to the product!
Please check through this manual on your new inverter before operating.

I. Use of battery (DC power)

- 12V Battery : When using 500 watts of output (120V AC) with a 100A battery, you can use this product for 2 hours (8.3A used under 100W) in optimal conditions.
 - 24V Battery : When using 500 watts of output (120V AC) with a 100A battery, you can use this product for 4 hours (4.2A used under 100W) in optimal conditions.
 - 48V Battery : When using 500 watts of output (120V AC) with a 100A battery, you can use this product for 8 hours (2.1A used under 100W) in optimal conditions.
-

II. Use of AC power outlet (120V AC)

The product has an output function of 120V AC.

Although the output AC cord is different based on thickness, 150 Ft. length can be used in general conditions.

III. Alarm display function (red LED)

- Output short circuit
 - Output overload
 - Over temperature protection
 - Battery low voltage (alarm/LED)
 - Battery high voltage (alarm/LED)
-

IV. Fan operation

Based on the 120V AC load of this product the fan automatically operates when the temperature increases.

Thermal fan engages at 104°F~113°F

Input Battery Connection Method

- Input connection diagram

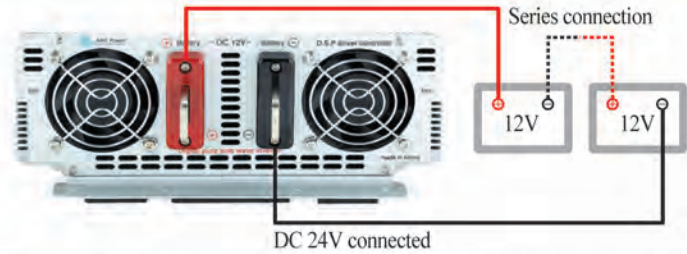
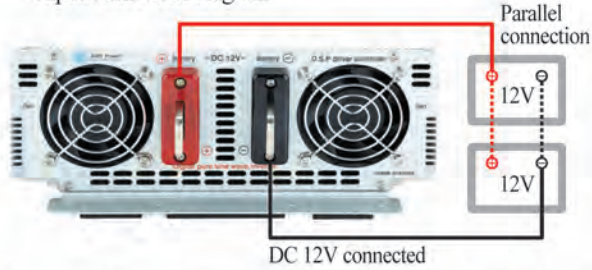

- Output connection diagram



Caution

Avoid installing this inverter in a sealed area, or an area with poor ventilation/excessive heat



Warning

This product contains battery connections and sparks can easily occur. To prevent fire or other accidents, do not install this inverter in a small or partitioned area with flammable materials. Wet or moist environments are fatal to this inverter. Special care shall be taken, keep inverter out of direct sunlight.

• Input connection diagram

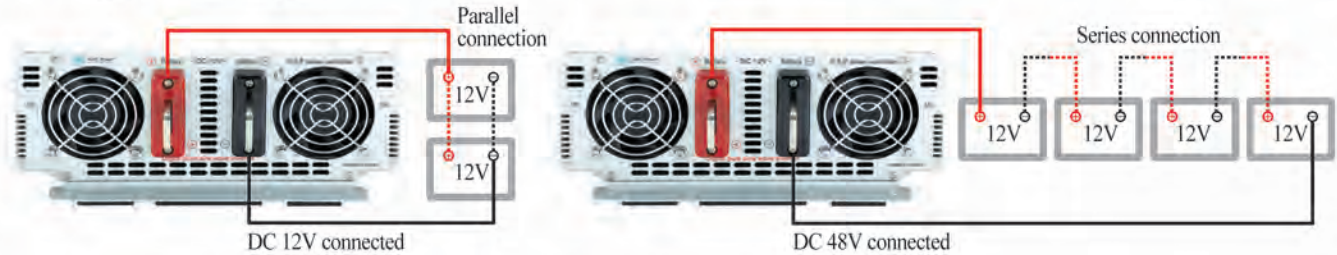

• Output connection diagram

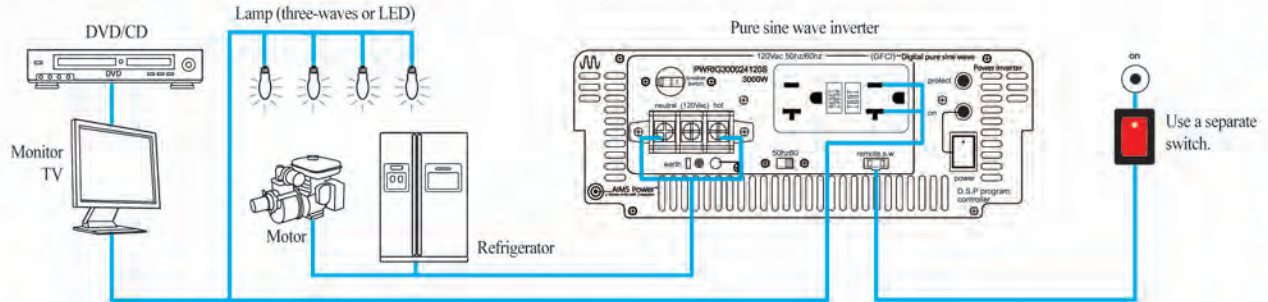

Caution

Avoid installing this inverter in a sealed area, or an area with poor ventilation/excessive heat



Warning

This product contains battery connections and sparks can easily occur. To prevent fire or other accidents, do not install this inverter in a small or partitioned area with flammable materials. Wet or moist environments are fatal to this inverter. Special care shall be taken, keep inverter out of direct sunlight.

❖ Operating Procedure

- A. Verify the battery operating Voltage And protection switch is on (inverter off).
- B. Turn protection switch #1 “off” (circuit breaker) once the battery connection has been verified.
- C. Turn protection switch #3 “off” If the buzzer is sounding, turn the connected AC devices off and toggle the power switch off then on.
The buzzer should stop.
- D. Connect the battery cable to terminal #1 (\oplus is Red, \ominus is Black, refer to figure #1). The length of the cable may vary slightly, but should preferably be less than 10 Ft. The shorter the length of the cable the better the batteries will perform.
If a longer distance is needed, a larger gauge cable is required.
- E. Connect the Red cable lug to the positive \oplus on the battery and Black lug to the negative \ominus of the battery.
Arrange the battery cables to the safest angles.
- F. Now you should connect and turn the AC devices on. Most equipment using motors, have a higher startup requirement.
This may cause the inverter to buzz and go into overload or pop the circuit breakers. This should not damage the inverter; however you should not continue to try and power up the equipment. Repeated overloads will cause damage to the inverter Call AIMS Power Tech support and verify startup requirements.
- G. The frequency of the inverter is fine-tuned at 60Hz from the manufacture.
You may however find it convenient and necessary to adjust it using switch #10 to 50Hz.
- H. The inverter may operate in overload for a short period of time. If you continue the use in overload, the inverter may overheat and shut down. You will then be required to turn the inverter off and on again.

❖ Overview

- PWRIG800012120S
- PWRIG800024120S
- PWRIG800048120S
- PWRIG500012120S
- PWRIG500024120S
- PWRIG500048120S

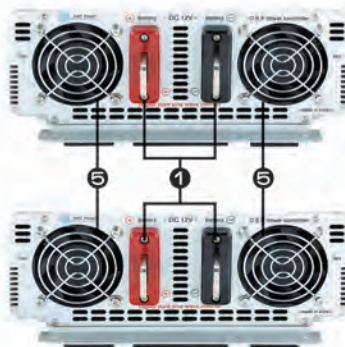
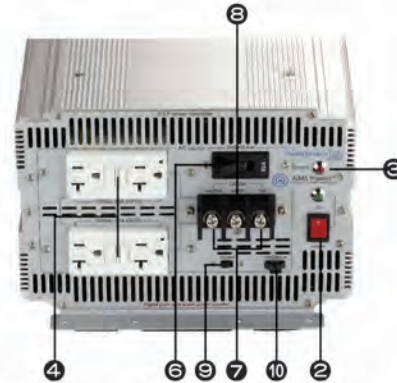

- PWRIG200012120S
- PWRIG200024120S
- PWRIG200048120S
- PWRIG300012120S
- PWRIG300024120S
- PWRIG300048120S



❖ Important:

Locate the number below to the number on Front or Back of the inverter on the Overview page 10.

1) Input Terminal (12V, 24V or 48V)

Prior to any connections make sure you match the battery Voltage to the inverter input Voltage. You will probably notice an arc when connecting a discharged or new power inverter to your batteries. Make sure to connect battery (⊖) to Black and battery (⊕) to Red. Tighten terminals. In case of extreme vibration, go back and verify terminals are tight.

※ Tip : when connecting multiple 12Vdc batteries, connect all the Red (⊕) together and all the Black (-) together.

This will keep the input Voltage at 12Vdc. Never connect batteries with different Voltages unless you are certain of what you are doing.

2) Power Switch

This is the main unit Power Switch. When this is turned OFF, the inverter is off. When turned ON, the inverter is on. You may or may not have 120V AC out, depending on the two Protection Switches.

3) Overload Protection LED' s

When the inverters self-tests process completes, this red LED will illuminate. If this red LED is off, an internal error is indicated. First you will hear a buzzer, followed by this LED being illuminated. You should immediately turn off all of your equipment. The LED will automatically reset once the overload situation has been resolved. The overload may be caused by one or more of the following:

- Short circuit on AC line
- An actual overload occurred exceeding the inverters output power
- Over Temperature
- Low battery Voltage
- High battery Voltage

4) AC Voltage Source (this may be 110 or 120V AC 60Hz for US market)

Please make sure no other power source can ever feed back into these outlets. It will permanently damage the inverter and void the warranty.

5) Automatic Fan Operation

These fans are thermally controlled and will turn on automatically when needed.

6) Protection Switch

The Protection Switch is a circuit breaker. If the output is exceeded, the breaker will POP and you will have to manually reset it.

This circuit breaker will protect the inverter in case of Overload or short circuit. If you have to reset this breaker, you should verify the Startup and Running current (listed on equipment) requirements for you equipment. Startup may be several times higher than the running rate, and may cause this protection breaker to pop.

Example : air conditioners or air compressors have high startup ratings called Locked Rotor Amps (L.R.A.).

7) AC Terminal Block (120V AC) **only available for 2000 watts and above*

This Terminal block is a convenient way of direct connecting equipment to achieve the full output power of the inverter. Be very careful as these may be "hot" and if touched may cause severe injury and electrical shock.

Warning : It is recommended to have a professional electrician wire to these terminals.

If they are touched, they may cause severe shock and if wired incorrectly may cause permanent damage to the inverter and equipment, voiding warranty and in extreme cases may cause fire.

❖ Please see wiring diagram

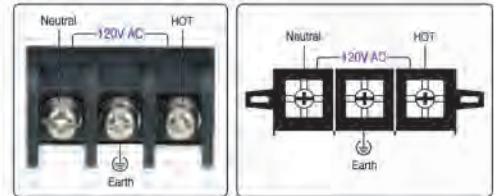

8) Case ground Terminal

We recommend you use this terminal to ground the inverter case. It may be required for certain appliance's or equipment's safety

*Some home installations will require this please check local laws and code regulations. Marine and automotive may not apply.

9) Selectable Frequency Switch

Selection is available between 60Hz and 50Hz. Convert and use according to the set frequency of the devices.

(60Hz is required in the U.S. market)

10) Remote Power Switch Terminal

If you need to mount an ON/Off switch for the inverter in a separate location for your specific application, you can use the supplied adapter to remotely locate any open/close ON/OFF switch that you choose.

❖ Troubleshooting:

For red LED and Protection switch

Symptoms	Possible problem	Possible solution
Warning red LED is illuminated and has low output voltage	Your device requires more power than the inverter is able to produce. The inverter has been overloaded.	Stop the operation of the connected devices Use the inverter under a lower condition than the specified output capacity (refer to instructions)
The output voltage is low or has no output voltage with small AC loads.	Check the charging status of the battery with a meter Check the durability of the battery with a meter Check all connections between battery and inverter	Check to see if the battery is fully charged with a meter. Check to ensure the correct wire gauge is connected between battery and inverter and AC output.
The warning red LED illuminates the overload alarm is beeping	Check for abnormalities on the devices connected to the inverter Check if the consumption powers of the devices are normal with a meter.	Remove devices operating abnormally. Check the inrush surge of all connected devices, MAX surge ability of the inverter is 200% of the output capacity for 500 milliseconds
Fuse breaks Protection switch has been tripped	Check all wiring connections. Check the devices connected to the inverter	Check the (Pos.) and - (Neg.) connections are made properly. Make sure the connected device does not exceed the capacity of the inverter
High output voltage is present output of the inverter has increased drastically	Check if the input voltage of the battery is correct at 12V, 24V or 48V DC	Turn off the devices connected to the 120V AC output of the inverter Check the voltage of the battery with an external multi meter.

Tips for improving inverter service life

Before using the inverter with heavy motors or appliances, it is wise to verify the startup requirements. This is most often much higher than the listed running requirements at 3 to 5 times the continuous current rating.

To keep the life expectancy of the inverter at its maximum, please ensure plenty of ventilation

❖ General problems:

- Audio system noise* : Noise may be generated from the speakers or amplifier when using the inverter to power low-grade stereo systems and large portable radios. This is due to the interference between the electricity and current running through each device. You are hearing the RF generated by the inverter.
- TV interference* : The operation of this inverter may cause interference in receiving specific TV channels; in this case perform the following procedure's to try to resolve the problems.

Audio, TV and wireless devices shall be installed in an area as far as possible away from the inverter. Try installing a line filter on affected device.

❖ Cautions during use

- For normal operation, devices with excessive loads applied momentarily such as refrigerators, air conditioners, electric motors, hand tools Etc. Should be within 60% of the maximum output capacity of this inverter. Check the capacity of this inverter as well as the capacity of the intended devices to be used.
 - When the rated continuous capacity of the motor is equal to or greater than the rated capacity of the inverter, operation of the intended device may not be available due to the inverter's lack of surge ability. (Example. A 2000 watt motor with a 2000 watt inverter, the startup of the motor may be 6000 watts and cause the inverter to fail.)
 - Devices using heaters will increase the temperature of the inverter drastically. When using devices like this make sure to provide proper ventilation for the inverter. Improper ventilation will cause inverter shutdown and malfunction resulting in irreversible damage.
 - Audio and video devices shall be used within the maximum power rating of the inverter. If the rating capacity is exceeded there will be a momentary cut-off. For safe operation use 75%-80% of the listed capacity.
-

❖ Warnings:

- Never allow moisture into or around inverter. This will void your warranty
 - Allow plenty of ventilation around inverter. It needs air to keep cool, or it may get extremely hot and shut down
 - Avoid placing the inverter in direct sun light
 - Always keep inverters away from flammable objects
-

AIMS Power™ Warranty Instructions:

This product is designed using the most modern digital technology and under very strict quality control and testing guide lines. If however you feel this product is not performing as it should, please call

[Techsupport \(775\)359-6703 ex227](tel:7753596703)

Techsupport@aimscorp.net

We will do our best to resolve your concerns. If the product needs repair or replacement, make sure to keep you receipt/invoice, as that will need to be sent back along with the inverter prepaid to AIMS. You have a full 1 year from date of purchase warranty

Warranty

If the inverter still does not function correctly after troubleshooting, Please contact AIMS power tech support at Techsupport@aimscorp.net
(775) 359-6703 ex227

For additional products such as :

- Modified sine wave inverters
- Low frequency pure sine wave inverters
- Pure sine wave inverters
- Solar charge controllers
- Grid-tie inverters
- Inverter chargers
- Automatic transfer switches
- Customer sized cables
- Batteries
- Solar panels



AIMS Operating Corp. Inc. Aims Power warranty instructions.

This product is designed and is under very strict quality control and testing guidelines. If however you feel this product is not performing as it should, please contact us: Techsupport@aimscorp.net or (775) 359-6703 ex227.

We will do our best to resolve any of your concerns. If the product needs repair or replacement make sure to keep your receipt/invoice, as that will need to be sent back along with the package and RMA# to AIMS Power. You have a full 1 year warranty from the date of purchase. This warranty is valid world-wide with the exception that freight and duty charges incurred outside the continuous 48 States. User is responsible for return shipping. Except as provided above, AIMS makes no warranty of any kind, express or implied, including without limitation the implied warranties of merchantability and fitness for a particular purpose. In no event shall AIMS be liable for indirect, special or consequential damages. This warranty only applies to AIMS Power branded products. All other name brand products are warranted by and according to their respective manufacturer. Please do not attempt to return non-AIMS Power branded products to AIMS Power.