

**6 Stage
AIR PURIFIER**



MA-4000

INSTRUCTION MANUAL

CAUTION:
Read manual carefully for proper installation and
operation.

CONTENTS

Specifications.....	3
Features.....	3
Introduction.....	4
Installation.....	4
Back Cover & Filter Removal.....	5
Placing the Unit.....	5
Settings and Adjustments.....	6, 7, 8 & 9
Maintenance.....	9
Fan Cleaning	10
Replacing the Fuse.....	10
Troubleshooting.....	11&12
Applications.....	13
Filter Cleaning & Replacement.....	14
Warranty Information.....	15

MOUNTAINAIRE THREE YEAR LIMITED WARRANTY



SUNHEAT INTERNATIONAL will repair or replace any defective part or component of any unit for a full three year period.

The UV bulb is warranted for (1) one year from date of purchase.

The filters and ozone plates are not covered under this warranty. These elements will be directly impacted by the environment in which the unit is operated and will need to be replaced periodically.

The obligation of SUNHEAT INTERNATIONAL under this warranty is limited to furnishing at SUNHEAT INTERNATIONAL's option, a new or rebuilt component or part which becomes defective during the warranty period from the date of sale. The warranty does not include the furnishing of any labor involved or connected with such as that required to diagnose the necessity for replacement or repair or to remove or to install any such part or parts, nor does it include responsibility for any transportation expenses or any damages or losses incurred in transporting the unit to an authorized servicing dealer.

Warranty service must be performed by a factory authorized servicing dealer. All services will be provided during normal business hours.

Owner's responsibilities include providing normal care and maintenance, providing proof of purchase upon request, expenses for delivery to and from the authorized SUNHEAT INTERNATIONAL servicing dealer. A copy of the original receipt must accompany all warranty claims.

Warranty is void if the serial number plate is defaced or where the defect is due to damage, product alteration, connecting to an improper electrical supply, act of God, or not used in accordance with the use and care instructions.

SUNHEAT INTERNATIONAL SHALL NOT BE RESPONSIBLE FOR ANY INCIDENTAL OR CONSEQUENTIAL DAMAGES.

SUNHEAT Warranty Registration

To activate warranty you must return this card within 30 days of purchase to:

**SUNHEAT International
3724 Arch Ave, Grand Island NE 68803**

NAME: _____ PHONE: _____

ADDRESS: _____

CITY: _____ STATE: _____ ZIP: _____

EMAIL ADDRESS: _____

DEALER PURCHASED FROM: _____

DEALER'S ADDRESS: _____

DEALER'S PHONE: _____

MODEL #: _____ SERIAL #: _____

DATE PURCHASED: _____

CHECK TO RECEIVE INFORMATION ON REPLACEMENT FILTERS

Filter Cleaning and Replacement

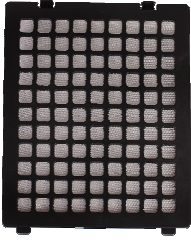

Pre-Filter - clean regularly by removing the filter from the unit and vacuum the filter with the hand held attachment to remove pet dander, dust, and other large particles. The Pre-filter can also be cleaned by running it under cool water and then use a toothbrush to gently remove particulates.



HEPA Filter - clean regularly; once per month is recommended but it may need to be cleaned more often for environments with pets or in a rural setting.

To clean, vacuum the filter with the hand held attachment to remove pet dander, dust and other large particles. The HEPA filter can also be washed by running it under cool water and then use a toothbrush to gently remove particulates. The HEPA filter should be replaced each year.

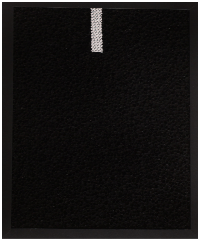

Carbon Filter - cannot be cleaned - **DO NOT WASH.**

Under normal conditions this filter should be replaced each year. If heavy chemicals or gases are in the environment the filter may need to be replaced more often.

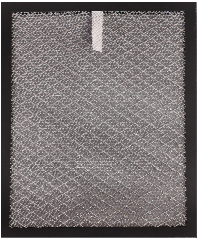

Titanium Oxide Filter (TiO₂) - **DO NOT WASH.**

Under normal conditions this filter should be replaced each year.



UV-C Bulb - Do not touch bulb with your hands, use latex gloves whenever replacing bulb. Lifespan: 8,000 hours.

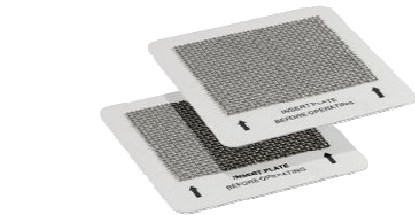

Ozone Plates - For maximum performance, ozone plates need to be washed in warm water. Always allow them to dry completely before re-installing.

SPECIFICATIONS

Model	MA-4000
Rated Voltage	USA-AC 120V/60Hz, Europe 230V/50Hz
Power Consumption	40W
Fan Speed (non-grade)	1500-3000 RPM
Air Volume	Max 106 CFM (3 m ³ /min)
Ion Output	≥ 5 x 10 ⁶ cm ³ (or ≥2.5 x 10 ⁶ /cm ³)
UV Spectrum	≥ 20iw/cm ² (at 10cm-distance)
Ozone Plates	2 Pcs, 4 1/2" x 4 1/2" (115mm x115mm)
HEPA Rate	Up to 99.97%
Remote Control	Distance ≤ 33 ft
Sound Level (DB)	Low 35 Med 45 High 50
Product size in inches	9" W x 11" D x 12" H
Gross Weight	11.75 lbs. (5.33 Kgs)

PRODUCT FEATURES

- Washable Permanent Pre-Filter
- Washable HEPA Filter
- Activated Carbon Deodorization Filter
- UV Bulb & TiO₂ Filter -Photocatalytic Oxidation (PCO) Process
- Negative Ion Generation Technology
- Adjustable Ozone Generation with Two Plate Configuration
- Adjustable Fan Speed Control (5 speed)
- Adjustable Ozone Output (5 levels) up to 3,000 sq. ft.
- Ion Output: 20 KV negative ion generator
- Remote Control
- Away and Sleep Settings

For Replacement Filters & Parts Call Customer Service
(877) 467-8643
 Or see your authorized SUNHEAT Dealer



To reduce the risk of electric shock, this equipment has a grounding type plug that has a third (grounding) pin. This plug will only fit into a grounding type power outlet. If the plug does not fit into the outlet, contact qualified personnel to install the proper outlet. Do not alter the plug in any way.



WARNING! - Do not operate without proper installation. Doing so may void the warranty.



CAUTION! – Cut off the power when performing maintenance.



If the fuse is blown and needs to be replaced, the current of fuse should be no more than 1.0 Amp.

The New Mountaineire Whole Home Purification System provides six stages of air cleaning. The MA-4000 removes odors caused by pets, tobacco and cooking. It's UV germicidal bulb and Negative Ion technology suppresses the growth of microorganisms like mold, mildew, bacteria, viruses and germs. The ozone generator system sanitizes up to 3,000 sq. ft. The Mountaineire fits neatly on a counter or desk; perfect for the home or office.

- Compact
- Portable
- No Duct Work Required
- No Chemicals
- Low Maintenance
- Economical to Operate
- User Friendly
- No Residual Contamination

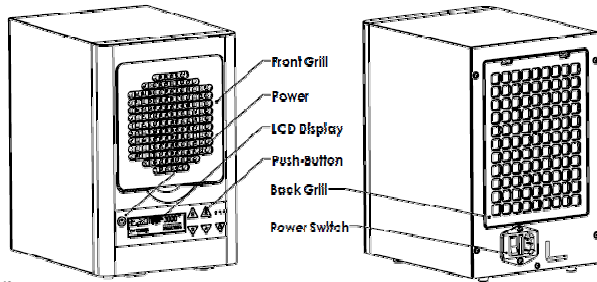

INSTALLATION

- 1) Remove unit from shipping carton.
- 2) Remove all protective materials.
- 3) Read Owner's Manual thoroughly prior to installation.
- 4) Fully insert cord into the power cord receptacle on the back of the unit.
- 5) Install Ozone Plates and Filters as shown in the steps on the next page.

Uses for your NEW Mountaineire Whole Home Purifier

Ammonia, Household Cleaners

The next time you use ammonia or other household cleaning products that produce a heavy odor, set your MA-4000 up in a high place in the area you are cleaning. Turn on the unit while cleaning and when you're done, use the appropriate ozone setting for the size of the area to clean the air. Leave the area and in a few hours the harsh odors will be gone.

Cooking Odors

The next time you are cooking fish, onions or any foods that produce a heavy odor, set your MA-4000 on the counter near the stove or anywhere in the kitchen. Turn on the unit while cooking and allow it to run until the odors are gone. You'll be delighted to notice how clean your home smells, even after cooking.

Closets and Sneakers

To remove odors from sneakers, place them in front of the unit overnight using one of the five ozone settings. To remove smoky odors from clothes and musty smells from closets set the MA-4000 on the appropriate ozone setting for the area, close the door and let the cleaning power of photocatalytics and ozone freshen your entire wardrobe.

Tobacco Odors

To remove odors from tobacco smoke, place the MA-4000 nearest to the area where you smoke. The carbon filter in the unit will trap the gases while the photocatalytic process destroys bacteria and germs. Occasionally, after a party or gathering, you may want to place the unit up high, maybe on a shelf, in the polluted area and set the purifier to the appropriate ozone settings. In a few hours those odors will be eliminated. Never place the unit where ozone will blow directly at you or your pets and choose the appropriate setting for the size of the area.

Bedding

Since you cannot take your bed to the dry cleaners, why not sanitize it by removing gases, contaminants and particulars from the fabrics with your Mountaineire? Set the unit on the bed and make a tent with your sheets. Let the unit run for a few hours and you will be surprised at how much cleaner your bedding smells.

Bathroom and Basements

To remove mold, mildew, germs, bacteria and other pollutants from bathrooms and basements, place the unit in the area overnight. You may choose to use one of the AWAY setting for large basements, but you will want to use the appropriate settings for the size of your bathroom. Allow the MA-4000 to sanitize the area from thirty minutes or overnight, depending of the area and the contaminants in the environment. You will be amazed at the results.

Pet Odors

To remove pet odors from your home, place the MA-4000 near your pet's litter box or bedding. The unit will not only collect the pet dander but the carbon filter will trap the gases while the photocatalytic process destroys bacteria and germs. Occasionally you may want to place the unit up high, maybe on a shelf, in the area near your pets bedding and/or litter box and set the purifier to the appropriate PURIFY setting. In a few hours those overpowering smells from pet urine and feces will be eliminated. Never place the unit where ozone will blow directly at your pets and please choose the appropriate setting for the size of the area.

Freshen Your Car

To remove the musty odor from your car, run an extension cord out to your car and plug in the MA-4000. Start the car and let it idle. Turn on the car's heating and air conditioning system and set the purifier to it's lowest ozone setting; let it run for a hour. The next time you turn on your car's heating and air conditioning system you will be greeted with a fresh clean sent.

Paint, Carpets and Construction

To remove the smells created by painting, installation for new carpet or other construction projects, place the Mountaineire up as high as possible, turn on the ozone generator to the appropriate setting and leave the area. In a few hours the chemical smells from these home remodeling projects should be gone.

Troubleshooting – What to look for first:

The fan is operating but the unit won't produce any ozone. What's wrong?

- Check the air purifier plate(s) for serviceability. If they are cracked or broken, the plate(s) will require replacement.
- Ensure maintenance procedures required for the air purifier plate have been performed (i.e. washing the Ozone plates). See page 5 for more details.
- Make sure the Ozone button is pushed to on.
- You will know the Ozone is on when a strong smell comes out of the air purifier. Aside from steps above, do not attempt to disassemble without contacting customer service or your dealer.

The unit has a burning smell, and/or appears to be arcing or sparking.

- Remove and clean the ozone plates and reinstall. If problems persist replace ozone plates.
- Ozone produces a smell or odor that smells like bleach or electric smell. This is normal during Ozone use.

If you have followed the troubleshooting procedures and are still experiencing issues with your Mountainaire please,

CONTACT CUSTOMER SERVICE

Toll Free (877) 467-8643

E-mail: customerservice@sunheat.com

BACK COVER & FILTER REMOVAL

Installing Ozone Plates and Filters

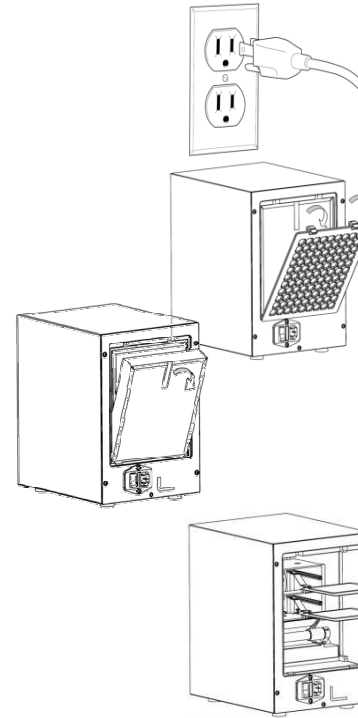

Step 1: Make sure the unit is unplugged before installing, removing any filters or maintaining the unit in any way, to prevent electric shock.

Step 2: Push the latches down on the back to remove the pre-filter. Then remove all the filters by pulling on the white ribbon at the top of each filter.

Step 3: Insert the ozone plates found in the small box. For maximum performance, ozone plates need to be washed in warm water before using. Always allow them to properly dry before installing.

Step 4: Reinstall all filters in the same order they were removed and reattach back cover.

Step 5: Determine placement location and plug unit into 120-volt outlet.

PLACING THE UNIT

In order to maximize the purification function, the unit should be placed as high as possible. A ceiling fan can also aid the unit with air purification.

Suggested locations, listed in order of preference:

- ⇒ Nearest to the source of the worst pollutant.
- ⇒ Near cold-air return in an air circulation system.
- ⇒ In the most frequently used area to achieve maximum benefit.

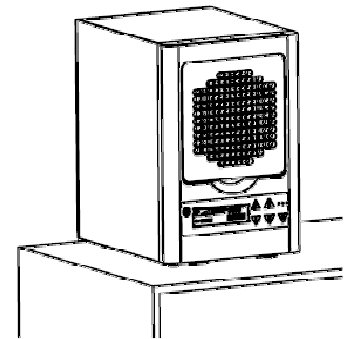

SETTINGS AND ADJUSTMENTS

Buttons function and Operation Description

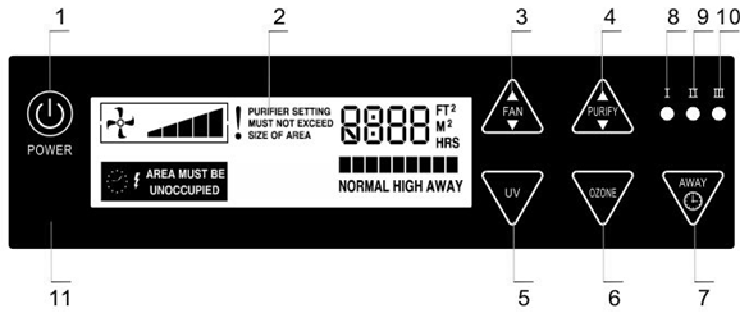

#	Name	Function & Operation
1	POWER	Standby mode: Press the POWER button to turn the unit on. Press again to turn unit off. Unit will operate at default settings for 1,600 sq. ft.
2	LCD Screen	Displays the unit's working status; FAN, PURIFY, OZONE and
3	FAN	Press to adjust the fan speed. (Note: the coverage area changes 200 sq. ft. each time the FAN button is pressed).
4	PURIFY	Press to adjust the ozone output - 0 to 5 settings - (Note: the coverage area changes 200 sq. ft. each time you press the PURIFY button).
5	UV	Press to turn the UV bulb on or off.
6	OZONE	Press to turn the ozone generator on or off (Note: The PURIFY settings do not work when OZONE is off).
7	AWAY	Air purifier works at maximum settings, 3,000 sq. ft., in AWAY mode. The purifier will shut off when the timer returns to 0. Press once for a 0.5 hour run time; Press twice for a 1 hour run time; Press third time for a 2 hour run time; Press again to return to manual mode.
8, 9, 10	LED lamps for Away Mode	Indicates timing mode: I means 0.5H; II means 1 hour; III means 2 hours.
11	Receiver	Infrared receiver (Note: do not block the receiver, otherwise it will affect the normal working of the air purifier).
12	Timer Off	Press buttons 3 & 5 at the same time, display will show 0:00 for timer, press button 4 (PURIFY) within 2 seconds to set timer. The time increases by 0.5 hour each time you press the button. When timer runs out, the unit will automatically revert to previous working status. (Note: press any button to turn off the timer function)

TROUBLESHOOTING GUIDE

Indicators of Operation:

(Operation of the Ozone & Power Indicator Lamp)

- The ozone generator should be operated when the room is unoccupied. Open the door and window when you return to the room if ozone operated for several hours.
- Turn the unit on and check that the small red/orange lamp is illuminated. The lamp is located on the front panel; one is silkscreen 'POWER' and the other is silkscreen 'OZONE'.

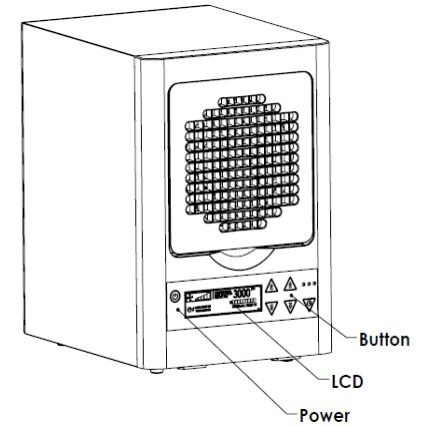

Troubleshooting – What to look for first:

Unit does not operate:

- Is the unit plugged in?
- Is the power cord fully inserted into the back of the unit?
- Are you sure the outlet is functioning normally?
- Is the unit turned on?

(The power switch, located on the back of the unit, marked I/O is flipped up)

- Is the back grill installed properly to depress the safety switch forward?

Air flow is restricted or reduced:

- Is the unit properly placed away from objects that may obstruct air flow?
- Are the filters clean?

I have plugged in the unit, turned the power switch, located on the back of the unit, to "ON" and pressed the POWER button and nothing is happening. What's wrong?

- Make sure the electrical outlet is capable of providing power to the unit.
- Check that the back cover is fully installed and snapped into place. If the back cover is not fully installed, a safety switch will not allow the unit to turn on.
- Check to see if the proper fuse is installed and that it is serviceable.
- Ensure that the fuse cap is completely seated and secured in its receptacle. See Page 10 for more details.
- Be sure the cord is fully plugged into the unit and also into the wall outlet.

Customer Service (877) 467-8643

Fan Blade and Front Grill Cleaning:

(Take off front/reinstall grill method)

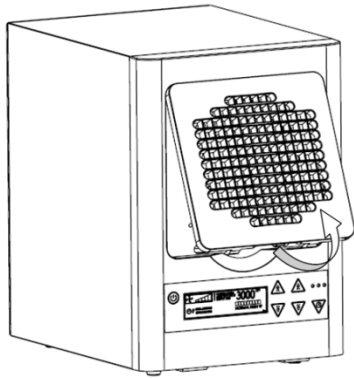

To remove for cleaning:

- ⇒ As the detail on the left shows, hold bottom of front grill and pull out.
- ⇒ When latch releases from front panel, lift front grill approximately 30 degrees.
- ⇒ Pull front grill away from unit in a parallel motion.

To reinstall after cleaning:

- ⇒ Place top latch of grill in front panel opening.
- ⇒ Push bottom latch of grill into bottom slot.

Cleaning Information:

Wipe off fan blade and front grill with damp washcloth. The fan requires no maintenance.

REPLACING THE FUSE

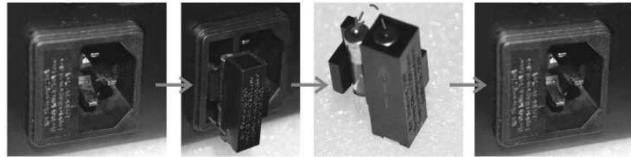

A fuse holder is located on the back of the unit next to the power cord.

To replace or check the fuse:

Remove the fuse holder by pressing on the clip and pulling straight out.

If the fuse is blown:

Replace with the standard replacement fuse. Insert the new fuse into the fuse holder. Press the assembly straight in until it latches.

120 volt models: Fuse rated at no more than 1.0 Amp.



CAUTION!

If the fuse holder cap is not installed correctly, the unit will not operate.

LCD Display

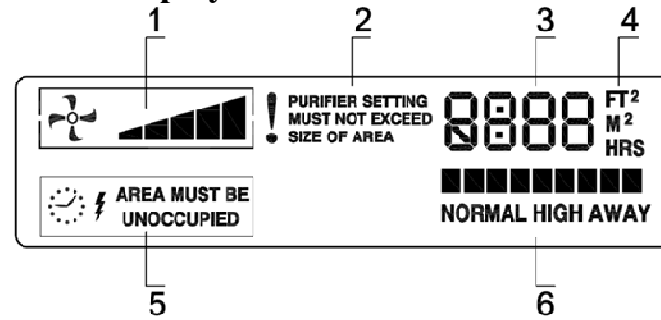

No	Name	LCD display
1	Fan working status	1 to 5 bars will be illuminated to indicate fan speed.
2	HIGH purifying reminder	When the coverage area is more than 2400 sq. ft, the LCD display will show HIGH.
3	Coverage area	It displays 1000- 3000 sq. ft. when working; the coverage area changes by 200 sq. ft. each time the FAN and PURIFY button(s) are pressed.
	Timing reminder	When the timing function is turned on, the countdown clock, purified area and timer will be displayed.
	Standby	Display will read 0000 and the LCD backlight will turn off at the same time.
4	FT ² / HRS	Display indicates the square foot covered. When set to "AWAY" the display will flash between HRS and FT ² .
5	Ozone function reminder	LCD displays "AREA MUST BE UNOCCUPIED" when ozone is on. (Note: ozone has obvious effects on killing germs and removing odors, however, excess ozone can have adverse health effects, therefore, it should be used in unoccupied spaces only)
6	Mode	Will display; NORMAL (1~5), HIGH (1~3), AWAY (1~3) according to different working settings and purified area settings.



CAUTION!

During Ozone mode this unit should never be placed where it can blow directly into the face of any person or pet.

Notes:

- ⇒ For maximum control, the unit should be placed where easy access to the control panel is possible.
- ⇒ The rear of the unit should always have at least six inches of open area to allow unrestricted airflow.
- ⇒ To prevent injury, be sure power cord is not accessible to small children.

Remote control function and description

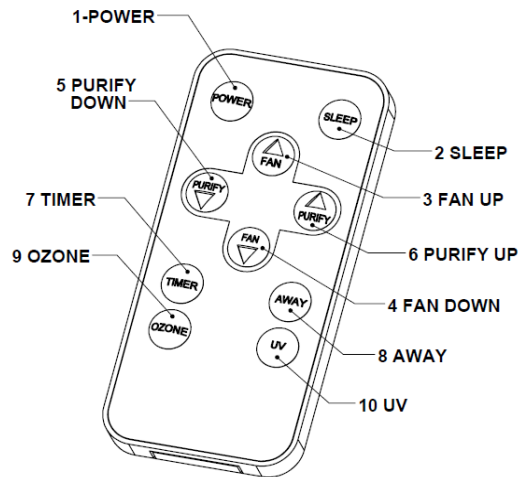

9	OZONE	Press to turn ozone on and off. Note: PURIFY does not work if ozone is off (Note: Ozone can only be used in an unoccupied space).
10	UV	Press to turn UV on or off.



CAUTION!

Always ensure the room or area is UNOCCUPIED before operating the above-described Ozone control.

No	Name	Function and operation instruction
1	POWER	Stand by mode: Unit will turn on when the Power button is pressed. Press Power again to turn unit off.
2	SLEEP	⇒ Press one time: 1200 sq. ft. SLEEP mode. ⇒ Press second time: 1000 sq. ft. SLEEP mode. ⇒ LCD display, UV bulb and ozone generator are off during SLEEP mode. Press any button to exit SLEEP mode.
3	FAN UP	To increase the fan speed press FAN UP (Note: Coverage area changes by 200 sq. ft. each time button is pressed).
4	FAN DOWN	To decrease the fan speed press FAN DOWN (Note: Coverage area changes by 200 sq. ft. each time button is pressed).
5	PURIFY DOWN	To decrease the ozone output, press PURIFY DOWN (Note: Coverage area changes by 200 sq. ft. each time button is pressed).
6	PURIFY UP	To increase the ozone output press PURIFY UP (Note: Coverage area changes by 200 sq. ft. each time button is pressed).
7	TIMER	1) Press TIMER button, clock will display 0:00 2) Press PURIFY UP within 2 seconds to adjust run time. Time will increase by 0.5H each time the button is pressed; maximum run time 9.5H, minimum run time 0.5H 3) When the time setting is finished, it enters automatic shut off mode, and back to normal working mode before time setting.
8	AWAY	Air purifier works at maximum function on AWAY mode. Press one time: shut off after 0.5H; Press second time, shut off after 1hr; Press third time, shut off after 2hr; Press again to return to manual mode.

MAINTENANCE

Periodic maintenance is required to ensure that your Mountaineer Air Purifier operates properly. A severely polluted environment can foul an air purifier plate in as little as four weeks or as long as a year. Shown here are basic maintenance procedures that should be carried out to keep your unit running at top performance.

Pre-Filter/HEPA Filter Cleaning:

(Turn to page 5 for removal instructions)

You have two options to clean filters:

- When filter is visibly dirty, simply remove the pre-filter or HEPA filter and clean the heavy particulate from the screen with a hand-held vacuum. This method will extend the life of the screen/filter.
- When filter is visibly dirty, remove the filter from the unit and wash it in cool water, brush it gently with a toothbrush to remove particulate. Dry completely prior to re-installing.