

SUNHEAT AND BEAT
Restaurant/Commercial
Electric Infrared Patio Heater



Safety Instructions and Operation Manual
Model: WL15BTS-B



Intertek

Caution:
Read manual carefully for proper installation and operation



CAUTION



1. **Use this heater only as described in this manual. Any other use not recommended by the manufacturer may cause fire, electric shock or injury.**
2. **To prevent overheating or possible fire, do not block front of heater. Do not insert or allow foreign objects to enter the front of the heater. Keep newspapers, table clothes, curtains, etc. from possible contact with heater.**
3. **A heater has hot and arcing or sparking parts inside. Do not use in areas where gasoline, paint or flammable liquids are used or stored.**
4. **Children should be properly supervised around all electrical heating devices. Some parts can become very hot and cause burns or injury.**
5. **Damaged power cords should be replaced by manufacturer or certified professional to avoid harm. Do not place cord under carpets, rugs or furniture.**
6. **The heater must not be located immediately below a socket-outlet and must be 6 feet above the floor.**
7. **WARNING: This heater is not equipped with a device to control the room temperature. Do not use this heater in small rooms when they are occupied by persons not capable of leaving the room on their own, unless constant supervision is provided.**

Brief Introduction

The SUNHEAT and BEAT Electric Infrared Heater is a radiant heater with remote control and is **IP 65 rated**. It has almost unlimited uses in outdoor areas, such as open bars, courtyards, patio, work station or outdoor gathering. This patio heater is energy-efficient, convenient, environmentally friendly and has Bluetooth, high quality speakers and LED lighting. Use our APP on your mobile phone or PC, to play the music, adjust heat levels, adjust the safety tilt, control LED lighting and more.

Important Safety Instructions

When using electrical appliances, basic safety precautions should always be followed to reduce the risk of fire, electric shock, or injury to persons, including the following:

Read all instructions before using this heater.

This heater is hot when in use. To avoid burns, do not let bare skin touch hot surfaces. If provided, use handles when moving this heater. Keep combustible materials, such as furniture, pillows, bedding, papers, clothes and curtains at least 3 feet from the front of the heater.

- Extreme caution is necessary when any heater is used by or near children and whenever the heater is left operating and unattended.
- Always unplug heater when not in use.
- Do not run cord under carpeting, throw rugs, runners, or similar coverings. Do not route cord under furniture or appliances. Arrange cord away from traffic area and where it will not be tripped over.
- Connect to properly grounded outlets only.
- To disconnect heater, turn controls off, then remove plug from outlet.
- Do not insert or allow foreign objects to enter any ventilation or exhaust opening, as this may cause an electric shock or fire, or damage the heater.
- No naked flame sources, such as lighted candles, should be placed on the apparatus.
- A heater has hot and arcing or sparking parts inside. Do not use it in areas where gasoline, paint, or flammable liquids are used or stored.
- Always plug heaters directly into a properly grounded socket. Never use with an extension cord or relocatable power tap (outlet/power strip).
- Check if the voltage indicated on the nameplate of the appliance corresponds to the local voltage before you connect the appliance.
- The appliance is not to be located immediately below a wall or ceiling socket-outlet.
- The casing and the front cover of the appliance become extremely hot

during operation. No combustible material should come in contact with the heater due to wind or other environmental influences that covers or obstructs the appliance, such as curtains, marquees, flags, plastic foil etc. Do not touch the appliance.

- In case of improper use, there is a risk of electrical shock and/or fire hazard.
- Do not touch the appliance while in operation. Caution! Risk of scald injury!
- Do not try to repair the appliance by your-self. Please contact SUNHEAT International or a suitably qualified electrician for maintenance.
- Remove the plug from the power outlet and wait until the appliance is sufficiently cooled off before cleaning.
- The appliance must only be mounted by an authorized specialist, paying attention to the relevant regulations of the power supply companies and the regional construction regulations.

Specifications

Specification	<input type="checkbox"/> SUNHEAT and BEAT
Voltage (V)	<input type="checkbox"/> 120V~
Power consumption (W)	<input type="checkbox"/> 1500W
IP code	<input type="checkbox"/> IP65
Infrared receiving Angle	<input type="checkbox"/> 60°±5°
Bluetooth receiver distance	<input type="checkbox"/> ≤65 feet
The speaker power	<input type="checkbox"/> 3W×2



BLUETOOTH OPERATION

A free Bluetooth App is available to download for this heater for either your iPhone, iPad or Android device.

The “SUNHEAT and Beat” App will allow you to connect remotely to several heaters, control lamp heat and speakers independently.

To download, search for “SUNHEAT and BEAT” in your App store and add to your device.









Bluetooth speaker connecting steps:

1. In standby position, press the  remote control button. Turn on the power of the Bluetooth speakers, then long press button  in order to enter into the Bluetooth pairing mode.
2. Open the Bluetooth function on your iPhone, iPad or Android device. Find the “SUNHEAT and Beat” in the device list and connect.
3. When connecting properly, there will be a prompt tone. Then start your music app on your device.
4. Press  again to turn off the Bluetooth speakers.

RESET OPERATION

- Press the Reset button on the side of the heater shortly, the power will be adjusted accordingly. (Low, Middle, High, ON/OFF)
- Press the Rest button for at least 4 seconds and the heater will restore factory settings.

Remote Control Instructions

	Button	Graphic	Feature
	Up Arrow		Up one heating level
	Turn off the speaker		Short press, turn on/off the speaker Long press, enter into Bluetooth pairing mode
	Down Arrow		Down one heating level
	LED light on		Turn on the LED light
	LED light off		Turn off the LED light
	On		To switch the heater on: Press ON. The patio heater has a soft start function of 33% power. 4 seconds after the heater has been turned on, it will automatically switch to the last heating level used. In case of the first-time use, after 4 seconds the heater will automatically switch to 100% power.
	Off		To switch the heater off: Press OFF. The heater will switch to standby mode (The receiver indicator will light up).

Notice:

- Use 2 AAA size 1.5V batteries in the remote control. Remove the battery when not in use for long periods, thus the lifespan of remote control can be extended.
- Choose the same model battery when replacing the battery inside, otherwise it may cause the remote control not work, thereby affecting the normal use of the heater.
- Please contact SUNHEAT International for further help if you need a replacement.
- The remote control function may not work if there is a barrier between the remote control and heater.
- Replace the batteries yearly so as not to affect the normal use of heater and remote control.

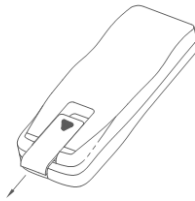
**Operation Instruction**

- Remove all package material (including anti-vibration object of the lamp) and check the appliance, supply cord and the plug for signs of damage.
- Pay attention to the mounting place and all mounting material (dowels, screws). Ensure they are suitable and stable enough for mounting and position of the appliance.
- Before mounting, the minimum safe mounting distances and tilt angles shown in the figures must be strictly followed.
- The distance between the bottom edge of the appliance and the floor must be at least 6 feet. See figure 2.
- There must be a distance of at least 1 foot between the appliance and the ceilings, roofs or other covers. See figure 2.

- There must be a distance of at least 2 feet at each side between the appliance and walls or the like. See figure 2.
- Recommended degree to mounting surface is 45°. See figure 3.
- Pay attention that, the installation of the appliance does not add excessive wind load.
- Fix the mounting bracket to the ceiling first. Ensure the place to be installed is secure and firm. Then fix the appliance to the bracket.
- Adjust the desired angle of radiation and test to make sure unit is secure. Periodiactly check to make sure unit is secure. Mechanical bearing pressure and oscillation due to wind or rain could lead to loose connections.
- Plug in the power source and operate the remote control. Then observe, the first 10-15 minutes to ensure the appliance works trouble-free.
- If you do not use heater for long periods, it is suggested to remove batteries from the remote.

Cleaning and Maintenance

- This appliance consists of a robust and maintenance-free aluminum casing with a protection cover. No user serviceable parts inside.
- Before cleaning, remove the plug from the power outlet and wait until the appliance has sufficiently cooled off.
- Wipe the appliance only with clean and lint-free cloth or a soft brush.
- Never use abrasive cleaners, scrubbing brushes and chemical cleaners for cleaning!
- Can use alcohol to clean the appliance.
- To protect against electrical shock and danger of life, do not immerse cord, plug, or any part of the appliance in water or other liquid.
- For heating element replacement, please contact the manufacturer or its service agent or a similarly qualified person.
- For other service, please contact with SUNHEAT International or a suitably qualified electrician.

Figure 1: Mounting bracket and anchor dowels provided. Connection from the wall to the infrared heater.

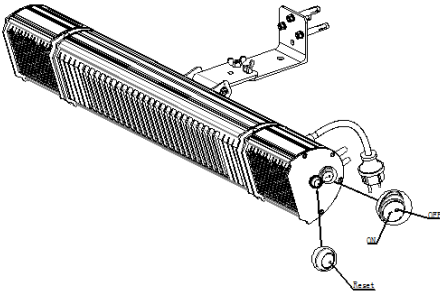

Figure 2: Min. distance to floor, ceiling and wall.

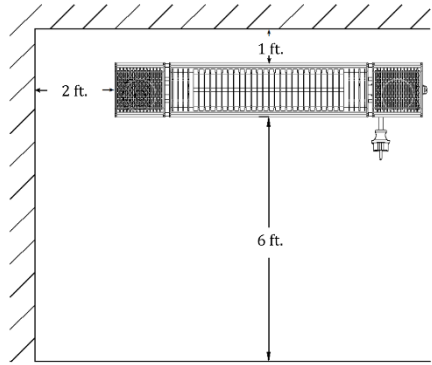

Figure 3: Tilt angle.

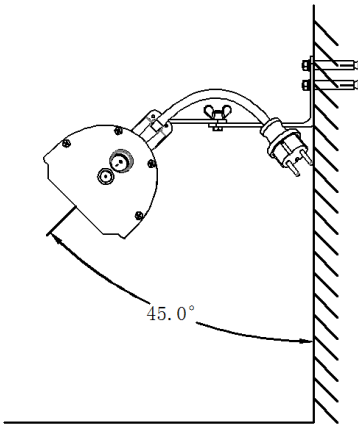
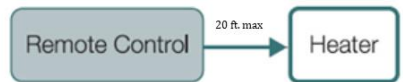

Figure 4: Max. remote distance



Storage

Do not wrap cord around the heater when placing in storage, or when heater is not in use.

Disposal



This marking indicates that this product should not be disposed with other household wastes throughout the EU. To prevent possible harm to the environment or human health from uncontrolled waste disposal, recycle it responsibly to promote the sustainable reuse of material resources. To return your used device, please use the return and collection systems or contact the retailer where the product was purchased. They can take this product for environmental safe recycling.

LIMITED ONE YEAR WARRANTY



Warranty

This product is inspected, tested and carefully packaged to minimize the chance of damage during shipment. If a part within one year from the date of purchase proves to be defective in material or fabrication under normal use, the part will be repaired or replaced. SUNHEAT International's obligation under the warranty is to replace or repair defective parts at our discretion. Any expenses or damage resulting from the installation, removal or transportation of the product are the responsibility of the owner and are not covered by this warranty. The owner assumes all other risks arising out from the use or misuse of the product. The warranty will be void if the product is damaged or failure is deemed by SUNHEAT to be caused by accident, alteration, misuse, abuse, incorrect installation or removal, or connection to an incorrect power source by the owner. SUNHEAT International neither assumes, nor authorizes any person or entity to assume, any obligation or liability associated with its products.

WARRANTY CLAIM PROCEDURE: Any product that proves to be defective within the warranty period must be delivered to the nearest SUNHEAT Warranty Service Center or to the address below. All transportation charges are the responsibility of the consumer. A copy of the original receipt must accompany all warranty claims.

SUNHEAT International
3724 Arch Ave
Grand Island, NE 68803
www.sunheat.com
1-800-652-1916

**SUNHEAT International
Warranty Registration**

Please return this card within 30 days of purchase to activate your warranty.

THANK YOU

NAME: _____ PHONE: _____

ADDRESS: _____

CITY: _____ STATE: _____ ZIP: _____

EMAIL ADDRESS: _____

DEALER PURCHASED FROM: _____

DEALER'S ADDRESS: _____

MODEL #: _____ SERIAL #: _____

DATE PURCHASED: Month _____ Day _____ Year _____

