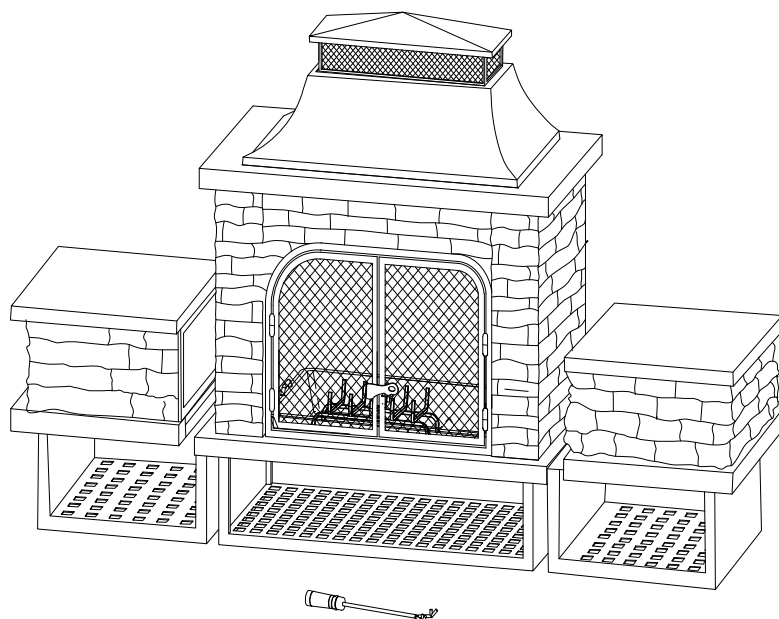


# ASSEMBLY INSTRUCTION

Item No.: A304001201



**WE HAVE YOU IN MIND, LET US SERVE YOU!**

Questions? Issues?

**CONTACT US**

24 hours / 7 days a week



[www.sunjoyonline.com](http://www.sunjoyonline.com)



[customer.care@sunjoygroup.com](mailto:customer.care@sunjoygroup.com)



1-(866)-578-6569

## Important Safety Instructions



**Warning!** Please read and understand this entire manual before attempting to assemble or operate this product.

**Caution!** Some parts may contain sharp edges. Please wear protective gloves during

- This fireplace is intended for outdoor use only. NEVER LEAVE A FIRE UNATTENDED.
- DO NOT use the fireplace to cook food. The fireplace is not designed for grilling food.
- DO NOT allow children or pets near the fireplace without supervision.
- DO NOT touch the surface of the fireplace while in use as it may cause burns.
- NEVER burn in vehicles, tents or indoors. CARBON MONOXIDE HAZARD.
- Use a poker and / or heat-resistant gloves to open / close the mesh cover while in use.
- DO NOT use water to extinguish as this is dangerous and can cause damage.
- Burn only untreated wood logs in this fire bowl.
- DO NOT use gasoline or kerosene to start the fire in this fire bowl.
- DO NOT use this fireplace on a wood deck, long or dry grass, leaves, or a combustible surface.
- DO NOT attempt to move the fireplace while it is hot or in use.
- Place the fireplace no closer than 8 ft. from walls or combustibles during use.
- Adequate fire extinguishing material should be readily available.
- The poker handle may become hot during and after use.
- Check local fire regulations and municipal by-laws for information regarding the safe use of this fire pit.

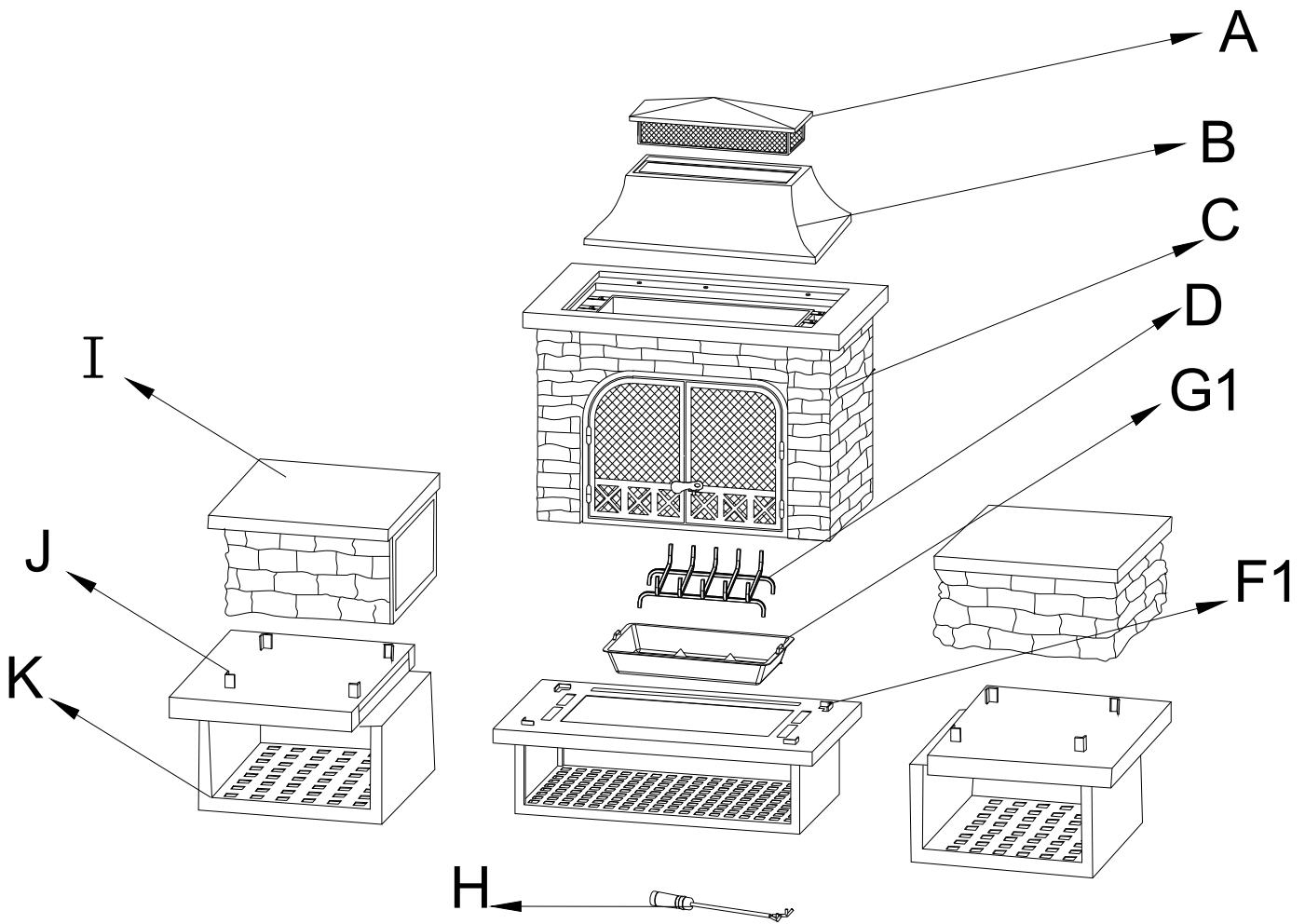


### Caution !



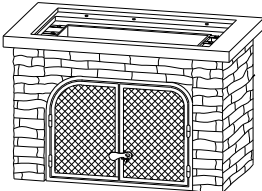

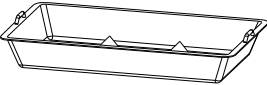
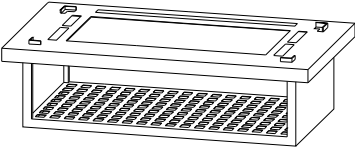

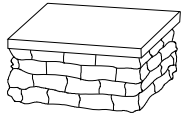

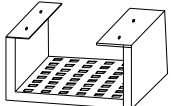
- Proper placement of your fire bowl is essential.
- Keep children away during assembly.
- This product contains small parts which can be swallowed by children.
- Keep fingers away from the places where they can be pinched or trapped.
- Please wear protective gloves during assembly.
- Do not attempt to assemble the fire bowl if any parts are missing.

Place all parts from the box in a cleared area and position them on the floor in front of you. Remove all packing materials and place them back into the box. Do not dispose of the packing materials until assembly is completed. Read each step carefully before beginning any assembly and make sure you understand each step.

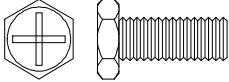


# Exploded Drawing



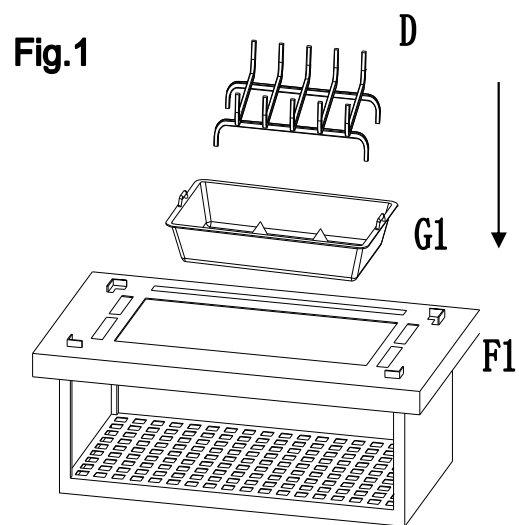
## Parts List

Label	Part Number	Description	Qty	Part Image
A	P000900085	Chimney	1	
B	P000300048	Top	1	
C	P007900072	Body	1	
D	P002800026	Grate	1	
G1	P003000013	Base	1	
F1	P000100306	Ash Tray	1	
H	P002700035	Porker	1	
I	P000100307	Side Table Top	2	
J	P000100308	Upper Side Base	2	
K	P000100286	Lower Side Base	2	

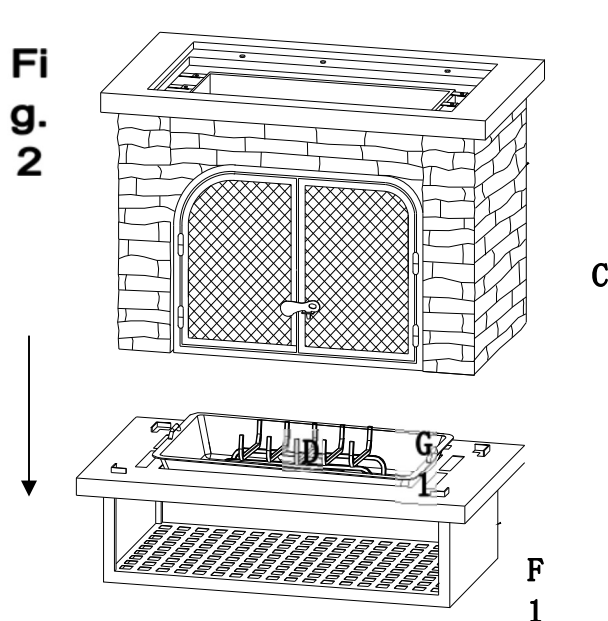
## Hardware Pack

Label	Part Number	Description	Qty	Part Image
AA	H02015C11	Bolt M6*15	8	
BB	H19001C11	Flat washer M6	8	
CC	H00001C12	Wrench M6	1	

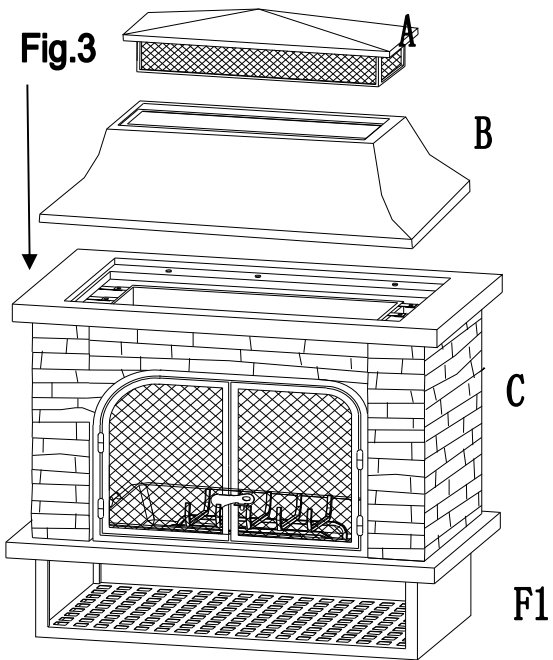
## Assembly Steps



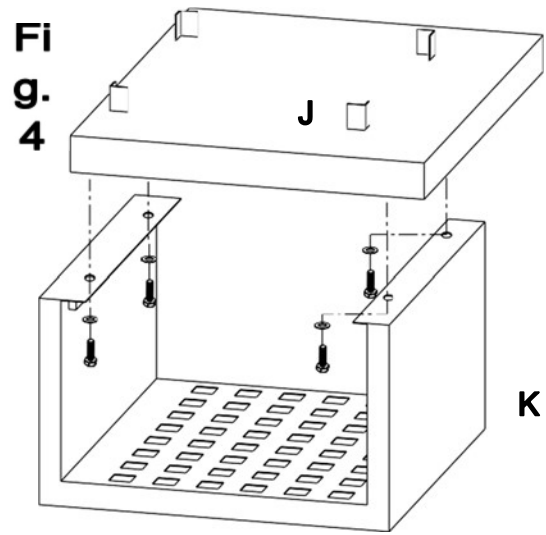
**Fig.1:** Put Grate (D) in Ash tray (G1), then insert the Ash tray (G1) into Base (F1).



**Fig.2:** Place Body (C) onto base (F1)

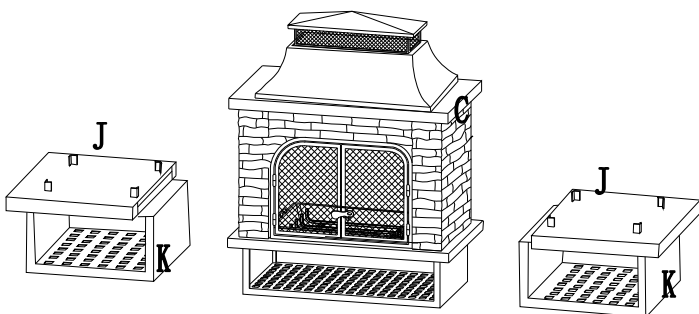


**Fig.3:** Put top (B) on body (C) and chimney (A) on top (B) in order as Fig.3



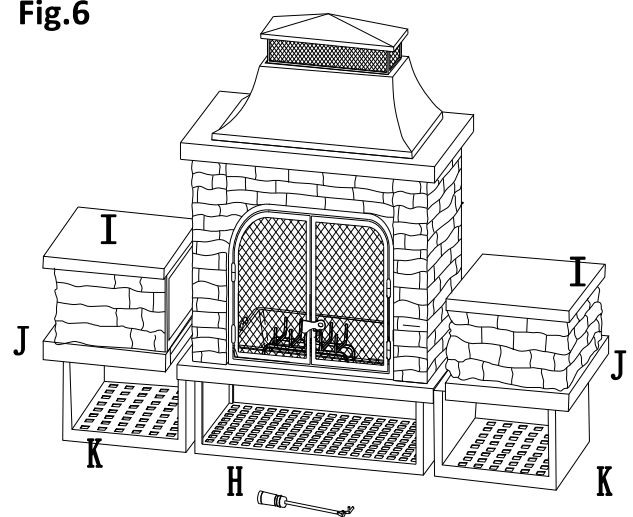
**Fig.4:** Attach upper side base (J) and lower side base (K) with bolt (AA) and flat washer (BB), as Fig.4

**Fig.5**



**Fig.5:** Insert the assembled side base (K) into Body (C).

**Fig.6**



**Fig.6:** Put the side table top (I) on assumed side base (J&K). (Note: The table top side without stone should face the body). Use Poker (H) as necessary. Now, your fireplace is ready for use.

## Cleaning and Maintenance



### Caution!

Check all screws and nuts periodically for tightness, fastening them again as required.

### Lighting

- Make sure there is only a small amount of ash in the bottom of the bowl.
- Place a layer of dry seasoned hardwood that covers no more than 3/4 of the bowl.
- Use a match to light kindling or fire starter.
- Use the poker that is provided to operate. Please wear heat-resistant gloves during use.

### Extinguishing

- Allow fire to burn itself out.
- DO NOT use water to extinguish as this is dangerous and can damage this fireplace.

### Cleaning

- This fireplace should be cleaned on a regular basis to promote safer experience and long product life.
- DO NOT attempt to clean this fireplace until the fire is COMPLETELY out and cool to touch.
- DO NOT use oven cleaner or abrasive cleaner as this will damage the fire bowl.

### Storage

- DO NOT move or store this fireplace until the fire is COMPLETELY out and cool to touch.
- Store the fireplace in a dry location to maximize product life.
- Store assembled fireplace in a location away from children and pets.

## LIMITED WARRANTY

This limited warranty is extended to the original purchaser and applies to defects in material and workmanship of your item provided the item is maintained with care and used only for personal, residential purposes. The manufacturer Sunjoy Group warrants this item is free of defects in material and workmanship for a period of **ONE YEAR**. If any defect is found, please call our Sunjoy Group customer service department at **1-866-578-6569** or email at **customer.care@sunjoygroup.com** for help. The manufacturer Sunjoy Group will not cover transportation or delivery costs or compensate the individual or any outside party for assembling or disassembling the product.