

Installation & Operation Guide



Electronic Entry Lock with Knob

Models 8732001, 8732101, 8732301, 8732401

Read this manual carefully before installing and operating!

Index

INSTALLATION INSTRUCTIONS

Package Contents / Tools Required.....	Page 1
Prepare Door and Jamb.....	Page 2
Adjusting Latch / Installing Latch.....	Page 3
Installing Exterior Assembly.....	Page 4
Installing Interior Assembly.....	Page 5-6

OPERATION INSTRUCTIONS

Exterior Assembly Overview.....	Page 7
Locking and Unlocking / Changing Programming Code / Adding User Codes.....	Page 8
Deleting User Codes / Automatic Lock Function / Temporarily Disable Auto Lock.....	Page 9
Vacation Mode / Secure Lock-out Period / Sound ON and Off Restore Factory Settings / Low Battery Warning.....	Page 10
Consumer Friendly Message Guide / Installation Trouble Shooting.....	Page 11
Consumer Assistance.....	Page 12
Programming Record.....	Page 13-14
Template.....	Page 15-16
Limited Warranty.....	Page 17

INSTALLATION INSTRUCTIONS

Package Contents

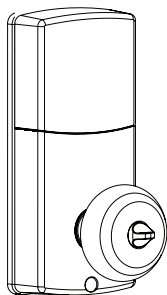

Interior Assembly

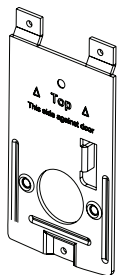

Mounting Plate

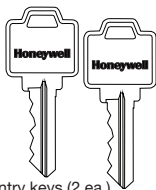

Entry keys (2 ea.)

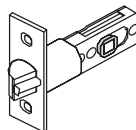

Latch (Adjustable)
2-3/8" (60mm) to 2-3/4" (70mm)

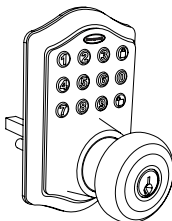

Exterior Assembly



Strike Plate



5/16" (8mm) Screws - 2 ea.



7/8" (22mm) Screws - 2 ea.

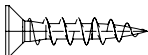

3/4" (19mm) Screws - 5 ea.



1" (25mm) Screw - 1 ea.

Tools Required

Tools Required for Installation on Pre-drilled Doors:

- Phillips Screwdriver

Tools Required for Installation on Doors That Require Drilling:

- Drill
- Tape Measure
- Pencil
- 2-1/8" (54mm) Drill Hole Saw
- 1" (25mm) Drill
- 1/16" (2mm) Drill
- Chisel
- Hammer
- Phillips Screwdriver

DO NOT RETURN TO STORE! If any parts are missing or damaged, please call Customer Service toll free at 1-877-354-5457 (M-F 7am - 5pm PST)

PREPARE DOOR AND JAMB

NOTE: For installation on doors with pre-drilled holes skip to 4e.

1. TEMPLATE

- Cut out template printed on page 15 of this Manual (Figure 1a).
- Fold template and place on door 36" (915mm) from the ground as marked (Figure 1b).



Figure 1a

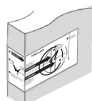

Figure 1b

2. MARK THE DOOR FOR DRILLING

- Mark center hole on door edge through guide on template for 1" (25mm) latch bolt (Figure 2a).
- Mark center hole on door face through guide on template for 2-3/8" (60mm) or 2-3/4" (70mm) backset (Figure 2b).

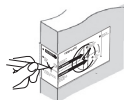

Figure 2a



Figure 2b

3. DRILL AND CHISEL DOOR

- Drill 2-1/8" (54mm) hole through door face as marked for lock set (Figure 3a).
- Drill 1" (25mm) hole in center of door edge for Latch (Figure 3b).
- Insert Latch in hole keeping it parallel to face of door. Mark outline and remove Latch (Figure 3c).
- Chisel 1/8" (3mm) deep or until latch face is flush with door edge (Figure 3d).

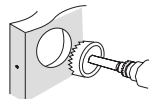

Figure 3a



Figure 3b

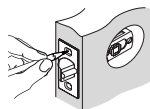

Figure 3c

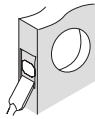

Figure 3d



NOTE: For Drive in Latch, drill hole size indicated on template and press until it is flush with door edge.

4. MARK AND DRILL DOOR JAMB

- Mark center hole on edge of jamb even with the center of the Latch Bolt on door edge. (Figure 4a).
- Drill 1" (25mm) hole 1-3/16" (30mm) deep in door jamb on center mark (Figure 4b).
- Outline outside edges of Strike Plate (Figure 4c).
- Chisel 1/8" (3mm) deep for Strike Plate or until flush (Figure 4d).
- Install Strike Plate using two 3/4" (19mm) screws provided (Figure 4e).

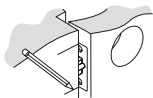

Figure 4a



Figure 4b

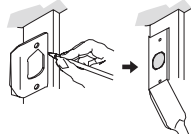

Figure 4c

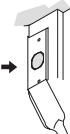

Figure 4d

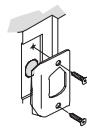

Figure 4e

ADJUSTING LATCH

NOTE: Latch is shipped with the backset set at 2-3/8" (60mm)

Measure the backset (backset is distance between edge of the door and the center of Lock).

TO CONVERT FROM 2-3/8" (60mm) BACKSET TO 2-3/4" (70mm) BACKSET

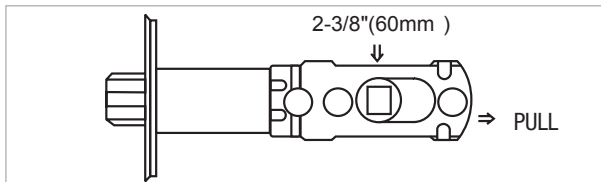

TO CONVERT FROM 2-3/4" (70mm) BACKSET TO 2-3/8" (60mm) BACKSET

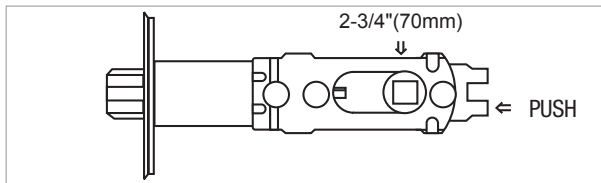

NOTE: Curved part of Latch always faces curved portion of Strike Plate

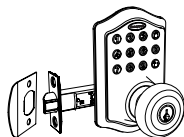

INSTALLING LATCH

5. INSTALLING THE LATCH (need phillips head screwdriver)

- Make sure the face plate sits flush with the door. Do not force the latch into the mortise flush. Chisel out excess material if necessary for a flush fit (Figure 5a).
- Using two 3/4" (19mm). screws provided, screw the latch into the door with a hand held screwdriver. DO NOT OVER TIGHTEN (Figure 5b).

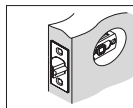

Figure 5a

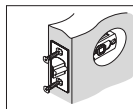

Figure 5b

INSTALLING EXTERIOR ASSEMBLY

6. INSTALLING THE EXTERIOR ASSEMBLY

Note: Work with the Door Open for easy access. To access the mounting plate, unpack the Interior Assembly and remove the battery cover by sliding the cover upward. Locate the screws holding the Mounting Plate to the Interior Assembly. Remove the screws to release the Mounting Plate from the Interior Assembly.

- Unpack the Exterior Assembly. Use care to not scratch the green circuit board during handling and installation.
- Check that the Rubber Gasket is properly seated on the Exterior Assembly (Figure 6a-b).
- Insert the Exterior Assembly onto the door with the tailpiece going through the Latch spindle in the **VERTICAL POSITION**. Route the Control Wire through the door over the Latch (Figure 6c).

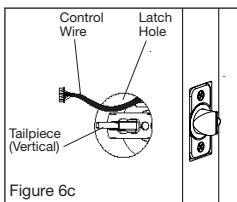
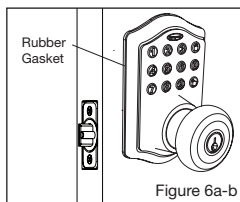

NOTE: Tailpiece must be positioned vertically

7. SECURING THE EXTERIOR ASSEMBLY TO THE DOOR

- From the side marked "This side against door", route the Control Wire through the rectangular slot in the Mounting Plate (Figure 7a).
- Place Mounting Plate against door with tailpiece passing through the center hole in the three hole set (Figure 7b).
- Secure the Mounting Plate to the Exterior Assembly using two 7/8" (22mm) Screws (Figure 7c).
- Hand tighten with a Phillips Screwdriver leaving loosely connected (Figure 7d).
- Check that the Rubber Gasket is properly aligned and correct as necessary (Figure 7e).
- Check vertical alignment of the lock (Figure 7f).
- Tighten securely with a hand held Phillips Screwdriver. **DO NOT OVER TIGHTEN**

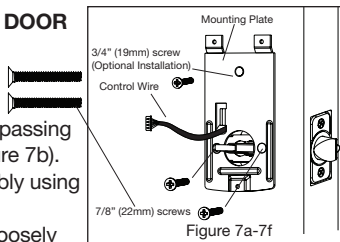

8. OPTIONAL INSTALLATION

- Using a 1/16" (2mm) drill bit, drill a pilot hole in your door using the Mounting Plate upper hole as a guide (Figure 8a).
- Insert one 3/4" (19mm) screw and tighten.

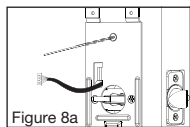

NOTE: Rotate knob to ensure the latch is opening and closing easily.

9. ATTACH THE CONTROL WIRE TO THE INTERIOR ASSEMBLY

- Use care to attach the Control Wire male plug to the Interior Assembly female socket connector (Figure 9a).
- Do not force the Control Wire male plug into the Interior Assembly female socket connector (Figure 9b).
- The Control Wire male plug has two alignment tabs on the smooth side of the plug which is the top of the plug (Figure 9c).
- The Control Wire male plug is inserted with the smooth side up into the Interior Assembly female socket connector (Figure 9d).

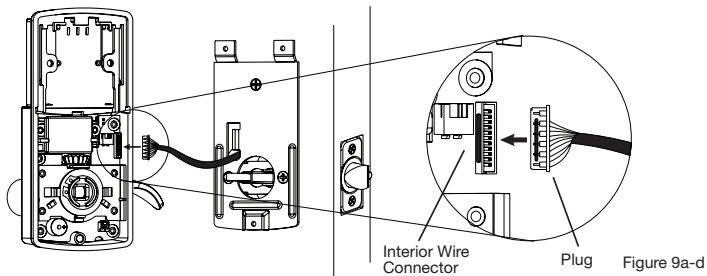

10. ATTACH THE INTERIOR ASSEMBLY TO DOOR

- Position the Interior Assembly over the tailpiece and push the Interior Assembly against the door (Figure 10a).
- Using two 5/16" (8mm) screws and one 1" (25mm) screw, attach the Interior Assembly to the Mounting Plate. **DO NOT OVER TIGHTEN SCREWS** (Figure 10b).



5/16" (8mm) screws



1" (25mm) screw

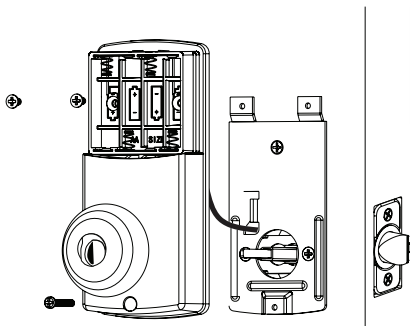

NOTE: Lock and unlock using Interior Knob to see if the latch is opening and closing easily.

INSTALLING INTERIOR ASSEMBLY (CONT.)

11. Installing Batteries

- a. Insert 4 AA high quality Alkaline batteries into the Battery Compartment in the direction noted +/- on the Compartment. The Lock will beep 2 times, the keypad will illuminate blue, and the Honeywell button will flash green twice to signify that it has received power (Figure 11a).

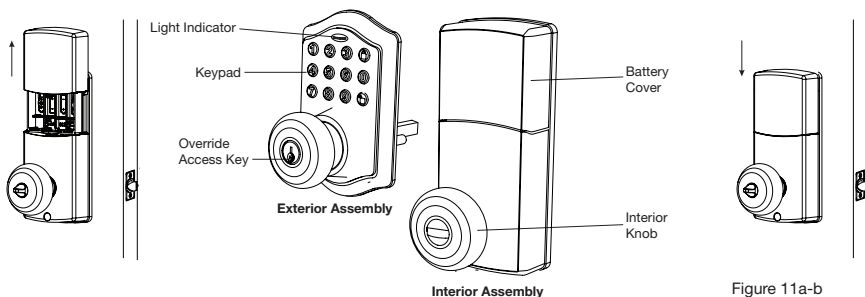

⚠ NOTE: Do not touch the Keypad until the blue light turns off. Do not use rechargeable batteries or non-alkaline batteries.

- b. Slide the Battery Cover down into the track on the Interior Assembly to cover the batteries (Figure 11b).



12. Testing Lock

With the Door Open

- a. Test the Lock using the Interior Knob. The Latch should move smoothly.
- b. Test the lock using the Keypad. To lock press  and then press "1234"  to unlock.

INSTALLATION OVERVIEW

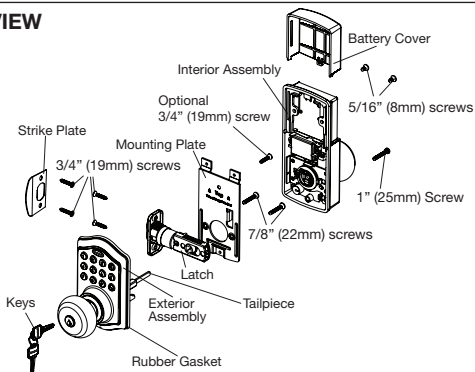

OPERATION INSTRUCTIONS

Exterior Assembly Overview

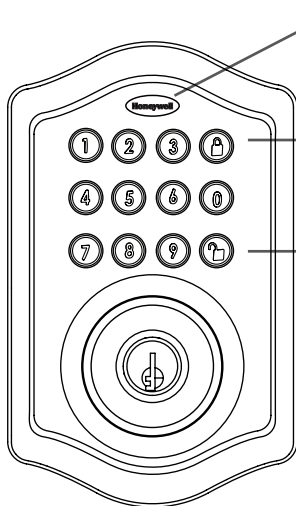

Indicator light

Green

- Indicates Successful Programming Step
- Indicates Unlocking is Successful

Red

- Indicates Failed Programming Step
- Indicates Locking is Successful



Lock button

Lock - Used to lock door

Clear - Used to clear wrong keypad entries



Unlock button

Unlock - Used to unlock door

Programming - Used in programming steps

Batteries (not included)

Electronic lock requires (4) High Quality AA Alkaline batteries. When all 4 batteries are installed in the correct position, hear 2 beeps and the keypad will illuminate blue. **DO NOT TOUCH** the keypad until the keypad stops illuminating.

Programming Symbols



Lock / Clear



Unlock / Programming



Programming Code



User Code (4-8 digits)



User ID (01-50, 2 digits)

Factory Settings

The lock comes factory preset with a:



Programming code - 123456





User code - 1234



User ID - 01



Please change the Programming

Code  and the User Code 
as soon as possible after installation
to insure security.

Programming Tips



5 Seconds - Complete all the programming steps in the programming mode within 5 seconds.

Clear - Use the  key to clear entries in case a wrong button is pushed.

Deleting User Codes

DELETE ONE EXISTING OR PRESET USER CODE

The unit comes with a factory User ID  = 01 for User Code  = 1234.

IMPORTANT: To delete 1 User Code , the lock must have more than 1 User Code  in its database.

 →  → 2 →  → Existing  →  re-enter  → 

Hear 1 beep and Light Indicator illuminates green.

DELETE ALL USER CODES

IMPORTANT: this will delete the user codes but not the programming code, enter the following.





 →  → 3 →  → re-enter  → 

Hear 1 beep and Light Indicator illuminates green.

Automatic Lock Function

SET OR CANCEL AUTO LOCK

You can set the lock to automatically close after each time the lock is opened. Time value range = 20 - 900 seconds, enter the following:

Set Auto Lock:  →  → 5 →  → Time Value → 

Hear 1 beep and Light Indicator illuminates green.

To cancel Auto Lock set the time to 00, enter the following:

Cancel Time Value Auto Lock:  →  → 5 →  → 00 → 

Hear 1 beep and Light Indicator illuminates green.

Temporarily Disable Auto-Lock

DISABLE:

While in Auto-Lock mode, unlock door using , within 10 seconds you must turn the locking knob by hand to the locked position, wait more than 2 seconds then turn the locking knob back to the unlock position. The Auto-Lock mode is now disabled.



RESTORE:

To restore the Auto-Lock function, you can turn the locking knob by hand to the locked position, wait more than 2 seconds or press the  Lock button on the keypad.

Vacation Mode

With Vacation Mode enabled, the system enters into low-power consumption mode. During this mode, all buttons and functions including the remote control will be invalid until they are re-enabled (see steps below).

ENABLE:

PC →  → 10 →  → 1 → 

Hear 1 beep and Light Indicator illuminates green then lock door

DISABLE:

To disable the Vacation Mode, you must press and hold  for more than 3 seconds, then input PC to unlock the door. Vacation Mode is now disabled.



NOTE: If you only press the  for more than 3 seconds but do not input PC, the system will remain in Vacation Mode.

Secure Lock-out Period

Warning sounds and LED flashes red after 4 incorrect code attempts: Keypad shuts down for 30 seconds.

Sound On and Off

You can “mute” or turn the “sound on” on your lock by entering the following. (Factory setting is sound on).

PC →  → 6 →  → 1 or 2 → 
1 = Sound Off
2 = Sound On

Sound Off (1) - Light Indicator illuminates green.

Sound On (2) - Hear 1 beep and Light Indicator illuminates green.

Restore Factory Settings

To reset the lock to the original factory settings including the Programming Code PC and all User Codes UC remove one battery for 10 seconds. Reinsert the battery and wait for a long and short beep. Press  3 times within 3 seconds. The lock will beep and the light indicator will turn green.

Low Battery Warning

Beeps and LED flashes red for 5 seconds. Replace with good quality alkaline batteries.

Note: Removing batteries does not erase active Programming or User Codes.

CONSUMER FRIENDLY MESSAGE GUIDE

Unlock / Valid programming:	1 long beep and LED illuminates green
Lock:	2 short beeps and LED illuminates red
Invalid Programming:	2 short beeps and LED flashes red twice
Low Voltage:	Beeps for 5 seconds (7/9 times depends on operation is unlock/lock)
Super Low Voltage:	4 short beeps and LED flashes red four times
4 Incorrect code entry attempts:	2 short beeps and LED illuminates red each attempt
Power on:	1 long beep and 1 short beep and LED illuminates green
Chip Reset:	1 long beep and 1 short beep and LED illuminates green (may occur several times or once in a while)
Lock Error:	3 long beeps LED flashes red three times
Repeat operation after Lock Error:	2 short beeps three times LED flashes red six times

NOTE: When battery is under low voltage, the lock will give the (Low Battery Warning: Beeps and LED flashes red for 5 seconds). During this time your lock can still work. However once the voltage is lower than 4.3V (called Super-Low Voltage), the operation of the locking and unlocking will not work, user must replace batteries immediately.

INSTALLATION TROUBLE SHOOTING

Issue	Solution
Lock will not function electronically	<ul style="list-style-type: none">• Check that all batteries are fresh high quality Alkaline Batteries• Check for proper polarity (+ -) of all batteries• Check that the Control Wire is attached to the Interior Assembly
Latch is sticking.	Installation screws of the lock may be too tight and have to be loosened <ul style="list-style-type: none">• Remove Interior Assembly• Slightly loosen the Mounting Plate Screws• Lock and unlock using the Key• Reattach Control Wire and Interior Assembly

CONSUMER ASSISTANCE

EMAIL: LHLPCustomerService@LHLPinc.com

WEBSITE: www.honeywellsafes.com

ADDRESS: Consumer Assistance Dept.
LH Licensed Products, Inc., 860 East Sandhill Avenue Carson, CA 90746 USA

TELEPHONE: US/Canada 1-877-354-5457 (Toll Free)

Mexico 01-800-288-2872 After English voice recording stops you must then enter 800-860-1677 to complete your call. (Toll Free)

Australia 0011-800-5325-7000 (Toll Free)

Germany/New Zealand 00-800-5325-7000 (Toll Free)

Other Countries XX*-310-323-5722 (Toll Charges Apply)
XX*- Dial U.S. Country Code first

CALL CENTER HOURS: US/Canada 7am – 5pm (Pacific**) Mon – Fri
(Subject to change)

CALL BACK HOURS: Other Countries 7am – 8pm (Pacific**) Mon – Fri
(Subject to change)
Pacific**- Local time in Los Angeles, CA, USA

* Insert correct Country Code

** Local Time based on Los Angeles California USA

INTERNATIONAL CALL BACK HOURS:

If you need to speak with a consumer assistant and cannot contact us during the Call Center hours above, please send an email or leave a telephone message, including your Name, Telephone Number and the best time for us to contact you during the Call Back hours above and we will make our every effort to contact you and help answer any of your questions or concerns.

Programming Record

My Codes:

Date Created

Programming Code	___	___	___	___	___	___	(6 digits)	/	/
User Code 01	___	___	___	___	___	___	(4-8 digits)	/	/
User Code 02	___	___	___	___	___	___	(4-8 digits)	/	/
User Code 03	___	___	___	___	___	___	(4-8 digits)	/	/
User Code 04	___	___	___	___	___	___	(4-8 digits)	/	/
User Code 05	___	___	___	___	___	___	(4-8 digits)	/	/
User Code 06	___	___	___	___	___	___	(4-8 digits)	/	/
User Code 07	___	___	___	___	___	___	(4-8 digits)	/	/
User Code 08	___	___	___	___	___	___	(4-8 digits)	/	/
User Code 09	___	___	___	___	___	___	(4-8 digits)	/	/
User Code 10	___	___	___	___	___	___	(4-8 digits)	/	/
User Code 11	___	___	___	___	___	___	(4-8 digits)	/	/
User Code 12	___	___	___	___	___	___	(4-8 digits)	/	/
User Code 13	___	___	___	___	___	___	(4-8 digits)	/	/
User Code 14	___	___	___	___	___	___	(4-8 digits)	/	/
User Code 15	___	___	___	___	___	___	(4-8 digits)	/	/
User Code 16	___	___	___	___	___	___	(4-8 digits)	/	/
User Code 17	___	___	___	___	___	___	(4-8 digits)	/	/
User Code 18	___	___	___	___	___	___	(4-8 digits)	/	/
User Code 19	___	___	___	___	___	___	(4-8 digits)	/	/
User Code 20	___	___	___	___	___	___	(4-8 digits)	/	/
User Code 21	___	___	___	___	___	___	(4-8 digits)	/	/
User Code 22	___	___	___	___	___	___	(4-8 digits)	/	/
User Code 23	___	___	___	___	___	___	(4-8 digits)	/	/
User Code 24	___	___	___	___	___	___	(4-8 digits)	/	/
User Code 25	___	___	___	___	___	___	(4-8 digits)	/	/

Programming Record Continued

My Codes:

Date Created

User Code 26	___	___	___	___	___	___	___	(4-8 digits)	/	/
User Code 27	___	___	___	___	___	___	___	(4-8 digits)	/	/
User Code 28	___	___	___	___	___	___	___	(4-8 digits)	/	/
User Code 29	___	___	___	___	___	___	___	(4-8 digits)	/	/
User Code 30	___	___	___	___	___	___	___	(4-8 digits)	/	/
User Code 31	___	___	___	___	___	___	___	(4-8 digits)	/	/
User Code 32	___	___	___	___	___	___	___	(4-8 digits)	/	/
User Code 33	___	___	___	___	___	___	___	(4-8 digits)	/	/
User Code 34	___	___	___	___	___	___	___	(4-8 digits)	/	/
User Code 35	___	___	___	___	___	___	___	(4-8 digits)	/	/
User Code 36	___	___	___	___	___	___	___	(4-8 digits)	/	/
User Code 37	___	___	___	___	___	___	___	(4-8 digits)	/	/
User Code 38	___	___	___	___	___	___	___	(4-8 digits)	/	/
User Code 39	___	___	___	___	___	___	___	(4-8 digits)	/	/
User Code 40	___	___	___	___	___	___	___	(4-8 digits)	/	/
User Code 41	___	___	___	___	___	___	___	(4-8 digits)	/	/
User Code 42	___	___	___	___	___	___	___	(4-8 digits)	/	/
User Code 43	___	___	___	___	___	___	___	(4-8 digits)	/	/
User Code 44	___	___	___	___	___	___	___	(4-8 digits)	/	/
User Code 45	___	___	___	___	___	___	___	(4-8 digits)	/	/
User Code 46	___	___	___	___	___	___	___	(4-8 digits)	/	/
User Code 47	___	___	___	___	___	___	___	(4-8 digits)	/	/
User Code 48	___	___	___	___	___	___	___	(4-8 digits)	/	/
User Code 49	___	___	___	___	___	___	___	(4-8 digits)	/	/
User Code 50	___	___	___	___	___	___	___	(4-8 digits)	/	/

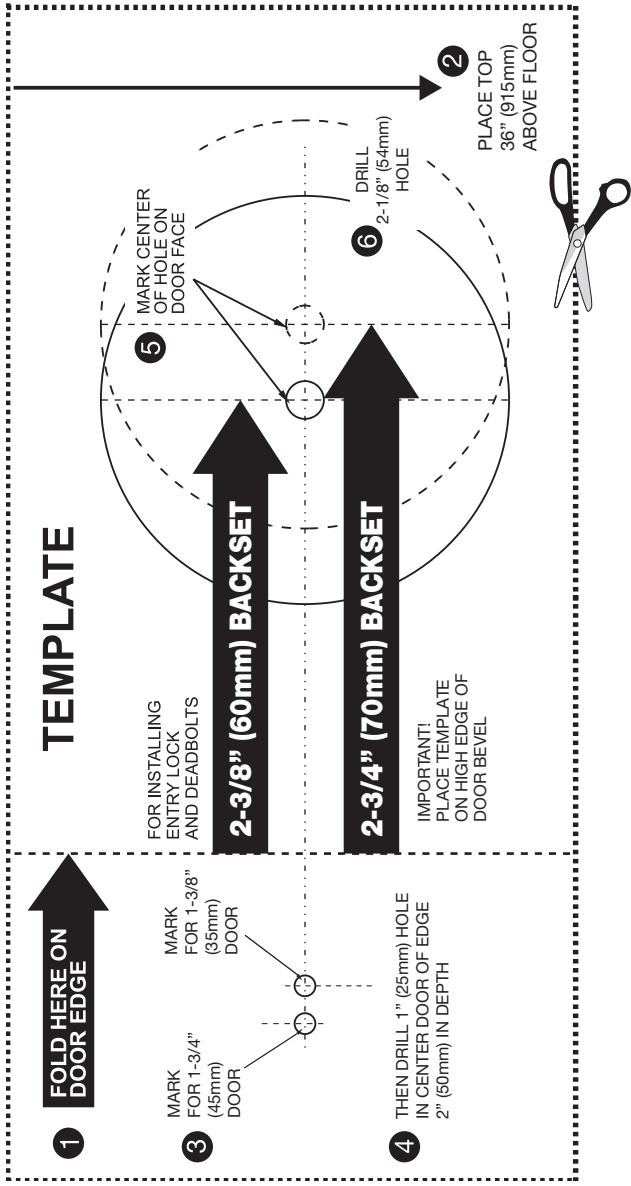

TEMPLATE

FOR INSTALLING
ENTRY LOCK
AND DEADBOLTS

2-3/8" (60mm) BACKSET

2-3/4" (70mm) BACKSET

IMPORTANT!
PLACE TEMPLATE
ON HIGH EDGE OF
DOOR BEVEL

5 MARK CENTER
OF HOLE ON
DOOR FACE

6 DRILL
2-1/8" (54mm)
HOLE

2 PLACE TOP
36" (915mm)
ABOVE FLOOR



4 THEN DRILL 1" (25mm) HOLE
IN CENTER DOOR OF EDGE
2" (50mm) IN DEPTH

3 MARK
FOR 1-3/4"
(45mm)
DOOR

1 FOLD HERE ON
DOOR EDGE

BACK OF TEMPLATE

Limited Lifetime Mechanical and Finish Warranty / 1 Year Limited Electronics Warranty

This product comes with a limited lifetime mechanical and finish warranty and a one year limited electronics warranty to the original residential consumer against defects in material and workmanship under normal use as long as the original residential purchaser occupies the residential premises upon which the product was originally installed.

ORIGINAL RESIDENTIAL CONSUMER

This warranty is not transferable, and applies to the original purchaser only, as long as the original purchaser occupies the residential premises upon which the product(s) was originally installed. Proof of purchase (original sales receipt) and ownership must accompany all warranty claims. All non-homeowner purchasers (including purchasers for industrial, commercial and business use) are not covered under the terms of this warranty.

WHAT IS NOT COVERED

This warranty is null and void if the product was used for purposes for which it was not designed. This warranty DOES NOT COVER normal wear and tear of parts or damage resulting from any of the following: negligent use, misuse or abuse of the product, or use contrary to or in violation of written instructions provided by LH Licensed Products, Inc. Further, this warranty does not cover Acts of God, such as fire, flood, hurricanes and tornadoes. This warranty DOES NOT COVER scratches, abrasions, deterioration due to the use of paints, solvents or use of cleaners containing abrasives, alcohol or other solvents, whether performed by a contractor, service company, or yourself. This warranty DOES NOT COVER product(s) used in commercial applications, used in common area applications, disassembly, repair or alteration by anyone other than LH Licensed Products, Inc., improper installation or exposure to extremes of heat or humidity. This warranty DOES NOT COVER any losses, injuries to persons or loss of property, general damages or costs, and shipping and freight expenses required to return product(s) to LH Licensed Products, Inc. LH Licensed Products, Inc. shall not be liable for any indirect, incidental or consequential damages of any nature relating to this lock. LH Licensed Products, Inc. is also not responsible for costs associated with removing or reinstalling the product.

ADDITIONAL TERMS

LH Licensed Products, Inc. does not authorize any person to create for it any obligation or liability in connection with the Product. LH Licensed Products, Inc.'s maximum liability here under is limited to the original purchase price of the Product. No action arising out of any claimed breach of this warranty by LH Licensed Products, Inc. may be brought by the original residential purchaser more than one (1) year after the cause of action has arisen.



Manufactured by:
LH Licensed Products, Inc.
860 East Sandhill Avenue
Carson, CA 90746

The Honeywell Trademark is used under license from Honeywell International Inc. Honeywell International Inc. makes no representations or warranties with respect to this product.