

User Guide



STEEL CASH DRAWER

Model 6313

Read this User Guide carefully and never store it inside the Cash Drawer!

WELCOME

Your new Honeywell Steel Cash Drawer will provide years of secure currency management. All Honeywell Cash Drawers are designed and built using the highest manufacturing standards to ensure maximum user satisfaction under a variety of conditions. Your Honeywell Cash Drawer will provide “Peace of Mind” for many years to come.

Thank you and enjoy!

PACKAGE CONTENTS

The following list outlines the items and quantities of each included with your new Cash Drawer. Please carefully check the list to confirm all items have been received. If any items are missing, please contact Consumer Assistance (See page 5 for contact information).

Steel Cash Drawer (1 ea.)

User Guide (1 ea.)

Access Keys (2 ea.)

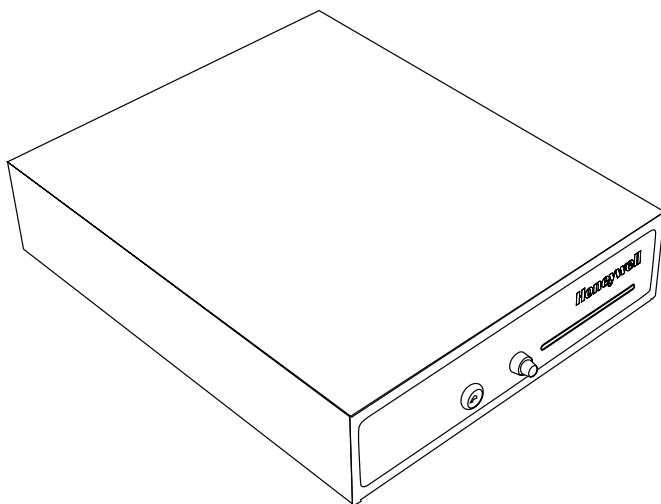

Attention: DO NOT RETURN CASH DRAWER TO STORE

If you are missing parts or have difficulty operating your Cash Drawer, please contact our Consumer Assistance Department by telephone. (See page 5 for contact information).

PRODUCT OVERVIEW

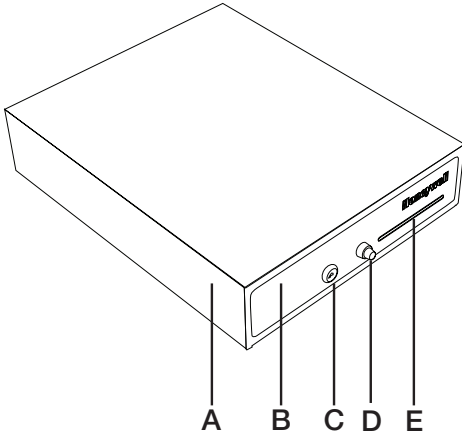

CASH DRAWER EXTERIOR

- A - Drawer Casing
- B - Cash Drawer
- C - Key Lock
- D - Cash Drawer Release Button
- E - Deposit Slot

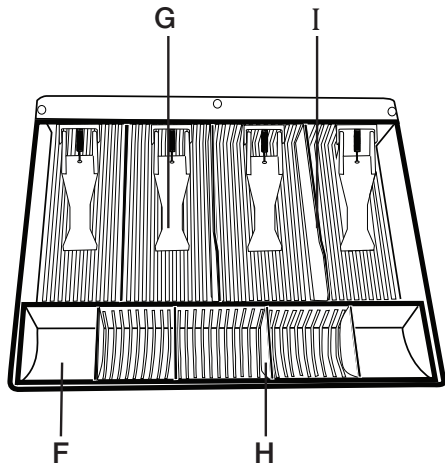

REMOVABLE CASH TRAY

- F - Removable Coin Tray
- G - Bill Clip
- H - Removeable / Adjustable Coin Tray Divider
- I - Removeable / Adjustable Bill Tray Divider

BEFORE USE

IMPORTANT - For your convenience, there are 4 rubber feet mounted on the bottom of the Cash Drawer to help protect against slipping while in use. For best results, place the Cash Drawer on a smooth level surface before operating.

OPENING AND CLOSING WITH KEY

IMPORTANT - For your convenience, there are 2 Cash Drawer Keys provided. Do not store keys in Cash Drawer.

TO OPEN:

1. Insert the key and turn $\frac{1}{4}$ turn to the right (clockwise) (Figure 1).
 2. Remove key then press in the Drawer Release Button and the Cash Drawer will open (Figure 2).
- Note:** It is best to remove the key after unlocking so that the latch does not re-engage during the transaction. Then immediately insert key and relock the drawer to complete the transaction.

TO CLOSE:

3. Push Cash Drawer into the closed position until the latch engages (Figure 3).
4. For added security insert key and turn $\frac{1}{4}$ turn to the left (counterclockwise) to lock Cash Drawer and remove key (Figure 4).

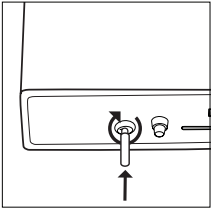

Figure 1

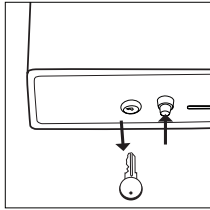

Figure 2

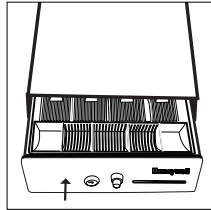

Figure 3

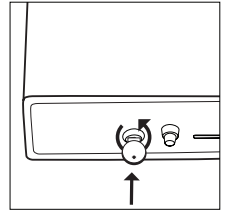

Figure 4

REMOVING THE COIN TRAY ONLY

REMOVING COIN TRAY

1. Insert the key and turn $\frac{1}{4}$ turn to the right (clockwise) (Figure 1).
2. Remove key then press in the Drawer Release Button and the Cash Drawer will open (Figure 2).
3. Pull Cash Drawer fully open until in stops (Figure 3).
4. Remove Coin Tray by grasping the sides and lifting straight up (Figure 4).
5. Reverse step 4 to reinsert the Coin Tray.

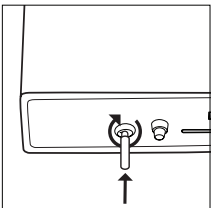

Figure 1

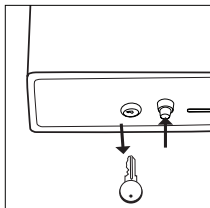

Figure 2

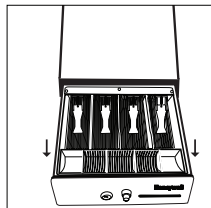

Figure 3

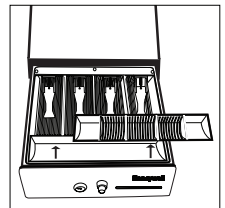

Figure 4

REMOVING THE CASH TRAY

TO REMOVE THE CASH TRAY INCLUDING THE COIN TRAY:

1. Insert the key and turn $\frac{1}{4}$ turn to the right (clockwise) (Figure 1).
2. Remove key then press in the Drawer Release Button and the Cash Drawer will open (Figure 2).
3. Pull Cash Drawer fully open until in stops (Figure 3).
4. Remove Cash Tray by grasping the sides of the Cash Tray and lifting straight up (Figure 4).
5. Reverse steps to reinsert the Cash Tray.

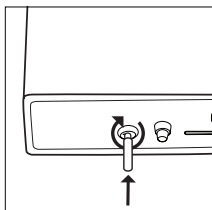

Figure 1

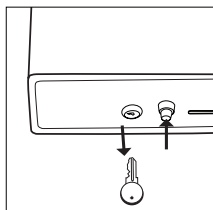

Figure 2

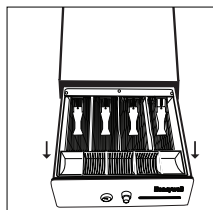

Figure 3

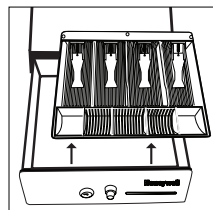

Figure 4

RECONFIGURING THE CASH TRAY

For your convenience, the Cash Tray has removable / adjustable inserts that can be reconfigured to accommodate many different currency note dimensions and coin quantities. Follow the steps below to remove or adjust the dividers.

TO REMOVE COIN TRAY DIVIDERS:

1. Remove the Coin Tray (Figure 1).
2. Flip Coin Tray over and release Locking Clips as shown (Figure 2).
3. Turn Coin Tray back upright and remove divider (Figure 3).
4. Replace in desired position and press down until the divider locks into place (Figure 4).

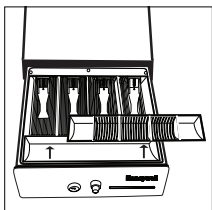

Figure 1

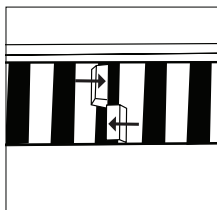

Figure 2

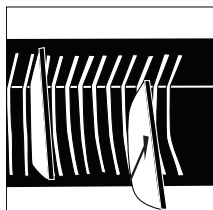

Figure 3

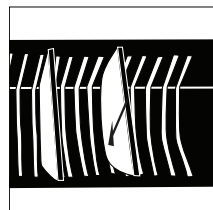

Figure 4

TO REMOVE THE BILL TRAY DIVIDERS:

1. Remove the Bill Divider by grasping and lifting up toward the front of the divider (Figure 1).
2. Insert the Bill Divider in the desired track rear first then align and lower the front (Figure 2).

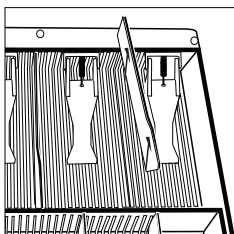

Figure 1

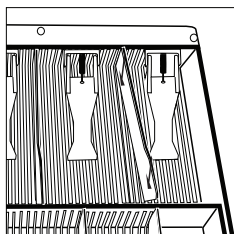

Figure 2

CONSUMER ASSISTANCE

EMAIL: LHLPCustomerService@LHLPinc.com

WEBSITE: www.honeywellsafes.com

ADDRESS: Consumer Assistance Dept.

LH Licensed Products, Inc., 860 East Sandhill Avenue Carson, CA 90746 USA

TELEPHONE: US/Canada 1-877-354-5457 (Toll Free)

Mexico 01-800-288-2872 After English voice recording stops you must then enter 800-860-1677 to complete your call. (Toll Free)

Australia 0011-800-5325-7000 (Toll Free)

Germany/New Zealand 00-800-5325-7000 (Toll Free)

Other Countries XX*-310-323-5722 (Toll Charges Apply)

XX*- Dial U.S. Country Code first

CALL CENTER HOURS: US/Canada 7am – 5pm (PST**) Mon – Fri (Subject to change)

CALL BACK HOURS: Other Countries 7am – 8pm (PST**) Mon – Fri (Subject to change)

PST**- Local time in Los Angeles, CA, USA

* Insert correct Country Code

** Local Time based on Los Angeles California USA

INTERNATIONAL CALL BACK HOURS:

If you need to speak with a consumer assistant and cannot contact us during the Call Center hours above, please send an email or leave a telephone message, including your Name, Telephone Number and the best time for us to contact you during the Call Back hours above and we will make every effort to contact you and help answer any of your questions or concerns.

ORDERING ADDITIONAL KEYS

The following information is required to order keys:

1. PROOF OF OWNERSHIP (1 of 2 Options Below)

A) SALES RECEIPT & IDENTIFICATION – INTERNATIONAL ORDERS ONLY!

- Copy of sales receipt showing Store, Date & Product Description.
- Copy of your picture I.D. (Drivers license, passport, regular I.D.).

B) PRODUCT OWNERSHIP VERIFICATION FORM

If sales receipt is not available, contact us by email or telephone to request a “Product Ownership Verification Form”.

2. ORDER INFORMATION

CONTACT

- Name & Shipping Address
- E-mail address (If Available)
- Telephone Number
- Best Time to Contact You

PRODUCT

- Model #
- Lock Key #
- Quantity of Keys Ordered

3. PLACING AN ORDER

- To begin the order process, contact us by telephone, email, or mail

4. METHOD OF PAYMENT

- Visa, MasterCard, Check or Money Order

NOTE: For pricing please contact Consumer Assistance. Contact information is located on page 5 of this manual. Payment method and pricing subject to change.

SAFE IDENTIFICATION RECORD

Model Number: 6313

Key Number: _____

Lock Number: _____

Limited Warranty

LH Licensed Products, Inc., (“LHLP, Inc.”) warrants that for a period of one (1) year from the date of purchase, this product will be free from structural or mechanical defects resulting from materials or workmanship. LHLP, Inc., at its sole option and as the purchaser’s sole remedy under this warranty, will repair or replace this product or any component of the product found to be defective during the warranty period. Replacement or repair will be made with a new or remanufactured product or component. If the product is no longer available, replacement may be made with a similar product of equal or greater value.

THIS IS YOUR EXCLUSIVE WARRANTY.

Our goods come with guarantees that cannot be excluded under the Australian Consumer Law. You are entitled to a replacement or refund for a major failure and for compensation for any other reasonably foreseeable loss or damage. You are also entitled to have the goods repaired or replaced if the goods fail to be of acceptable quality and the failure does not amount to a major failure.

This warranty is only valid for the original retail purchaser from the date of initial retail purchase and is not transferable. You must keep the original sales receipt. Proof of purchase is required to obtain warranty service.

LHLP, Inc. dealers, service centers, or retail stores selling this product do not have the right to alter, modify or in any way change the terms and conditions of this warranty.

This warranty does not apply to the finish on the product. This warranty does not cover normal wear and tear of parts or damage resulting from any of the following: negligent use or misuse of the product, use contrary to the operating instructions, disassembly, repair or alteration by anyone other than LHLP, Inc. or an authorized service center, improper installation, or exposure to extremes of heat or humidity. Further, the warranty does not cover Acts of God, such as fire, flood, earthquakes, hurricanes and tornadoes.

LHLP, Inc. shall not be liable for any incidental or consequential damages caused by the breach of any express or implied warranty or otherwise relating to the sale of this product. LHLP, Inc. is also not responsible for: costs associated with removing or installing the product; damage or loss of the contents of the product; nor for the unauthorized removal of the contents; or damages incurred during shipment.

THE ABOVE WARRANTY IS IN LIEU OF ALL OTHER WARRANTIES, EXPRESS OR IMPLIED, INCLUDING ANY WARRANTIES OF MERCHANTABILITY OR FITNESS FOR A PARTICULAR PURPOSE, AND LHLP, INC. DISCLAIMS ANY AND ALL OTHER COVENANTS AND WARRANTIES.

Except to the extent prohibited by applicable law, any implied warranty of merchantability or fitness for a particular purpose is limited in duration to the duration of the above warranty period. Some states, provinces or jurisdictions do not allow the exclusion or limitation of incidental or consequential damages or limitations on how long an implied warranty lasts, so the above limitations or exclusion may not apply to you. This warranty gives you specific legal rights, and you may also have other rights that vary from state to state, or province to province, or jurisdiction to jurisdiction.



Manufactured by:
LH Licensed Products, Inc.
860 East Sandhill Avenue
Carson, CA 90746

The Honeywell Trademark is used under license from Honeywell International Inc. Honeywell International Inc. makes no representations or warranties with respect to this product.