

(8) Pet bed fabric

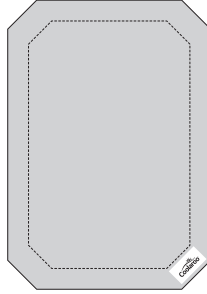

PARTS LIST		QTY
1	Rounded leg	4
2	Tapered side bar	2
3	End bar	2
4	Screws	4
5	Spring washer	4
6	Plastic insert	4
7	Tension adjustment tool	1
8	Pet bed fabric	1

**NO ADDITIONAL TOOLS NEEDED**



20 minute set up  
 (approximate time)

**Fig. 01**

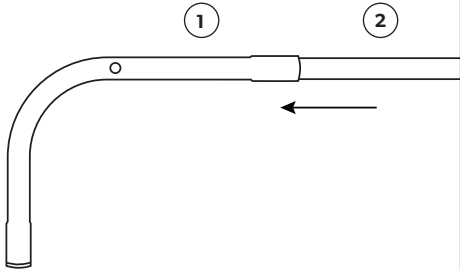

**Fig. 02**

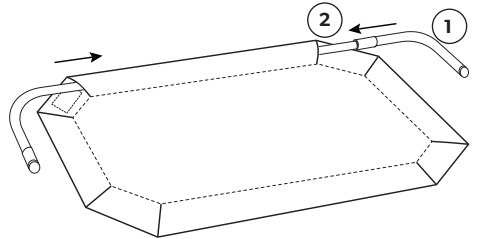

**Fig. 03**

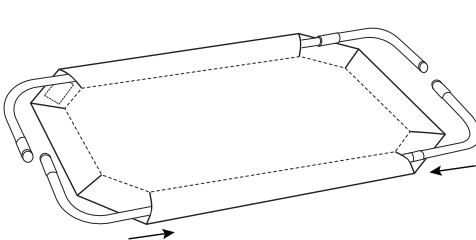

**Fig. 04**

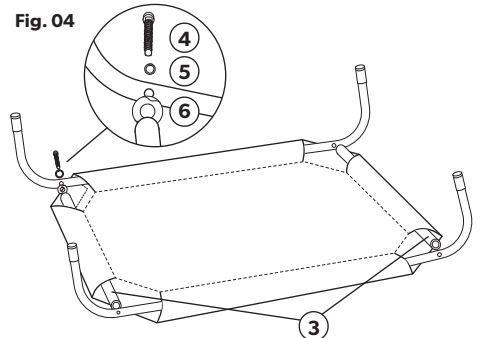
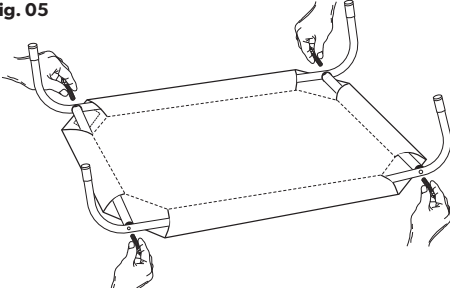
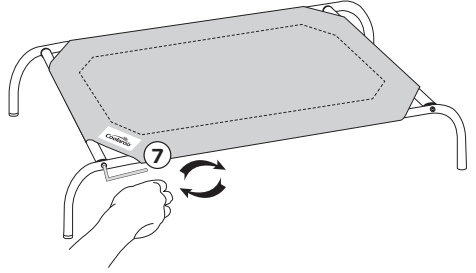

Fig. 05



**Note:** Before inserting screws, ensure the holes are aligned. Do not tighten screws complete yet.

Fig. 06



### Important Note

**MAINTENANCE:** Your Elevated Pet Bed has been made of the finest materials and, when properly cared for, will provide years of comfort and support for your pet. To clean, simply rinse with water, scrub with mild soap or any nonabrasive cleaner, rinse and air dry. Allow bed to dry completely before storing. Call us for missing parts or mechanical problems.

**CAUTION:** Use of solvents or abrasive cleaners may damage the fabric and will void your warranty. Do not use bleach or chlorine.

#### Questions or Comments? Contact us at:

Gale Pacific USA, Inc. | [www.coolaroousa.com](http://www.coolaroousa.com) | 1-800-560-4667

© by Gale Pacific Limited. All rights reserved. Coolaroo® is a registered trademark of Gale Pacific Limited.

