

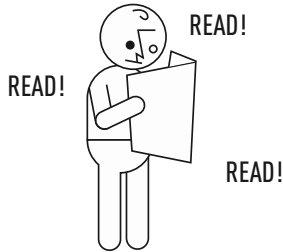

For successful assembly of your MODEL #4701 Chicken Coop with Herb Planter

Follow this pecking order

1



READ THESE INSTRUCTIONS!

If you've never followed instructions before, this is a good time to start! These tips have been compiled to lead you to a successful assembly. We know you can do this!

If you still run into trouble, you can call our Prevue Customer Service line at 1 (312) 243-3624.

2

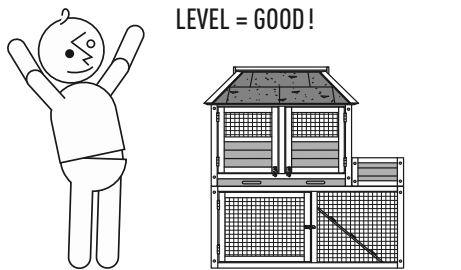

FIND A LEVEL SURFACE

Build your coop on a flat surface and, with a friend, carry it to the location where it will be used. Assembling the coop on the flattest surface available will help you greatly when squaring up panels and aligning the roof panels.

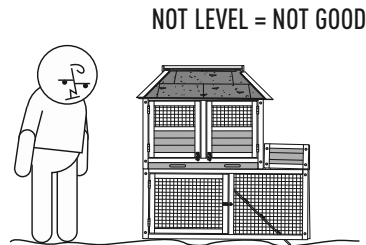

3

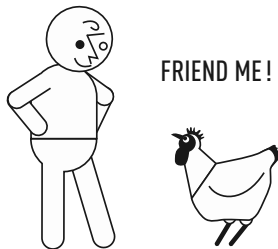

FIND A FRIEND (or GO IT ALONE—both are OK)

If you follow these steps, coop assembly will be easy for one person. But you may find a second person's assistance useful in some steps.

If you have to move the assembled coop to its final location, you will most certainly need assistance to protect the integrity of the structure.

4

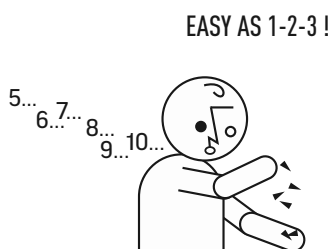

COUNT CONTENTS OF HARDWARE PACKETS

After unpacking all components, count the contents of the screw packets. Compare the counts against the Parts List on the next page. There should be at least one spare for each packet. If any packets are short, please contact Prevue or use your own appropriate-size replacements.



For successful assembly of your MODEL #4701 Chicken Coop with Herb Planter

Follow this pecking order

5



CARE ADVISORIES

For the comfort and health of your chickens, this coop size is most appropriate for 2 to 3 hens.

-

Use plastic or ceramic saucers or plastic tarp under all potted plants in the herb planter box to protect the wood from constant contact with moisture.

-

When moving the coop, remove the ramp and bar unit for safety.

CUSTOMER SUPPORT

Please contact Prevue Pet Products:

PHONE 1 (312) 243-3624

ONLINE www.prevuepet.com

EMAIL customerservice@prevuepet.com

These instructions are online, under the item's detail listing at www.prevuepet.com.

To maintain the longevity of your purchase, we recommend that you periodically treat it with a non-toxic sealant and protect it with a tarp or other covering during extended periods of inclement weather.



For more wonderful cages, toys, and accessories for dogs, cats, birds, chickens, rabbits, ferrets and small animals, visit www.prevuepet.com



MODEL #4701 Chicken Coop with Herb Planter

PARTS LIST

CUSTOMER SUPPORT

Please contact Prevue Pet Products:

PHONE 1 (312) 243-3624

ONLINE www.prevuepet.com

EMAIL customerservice@prevuepet.com

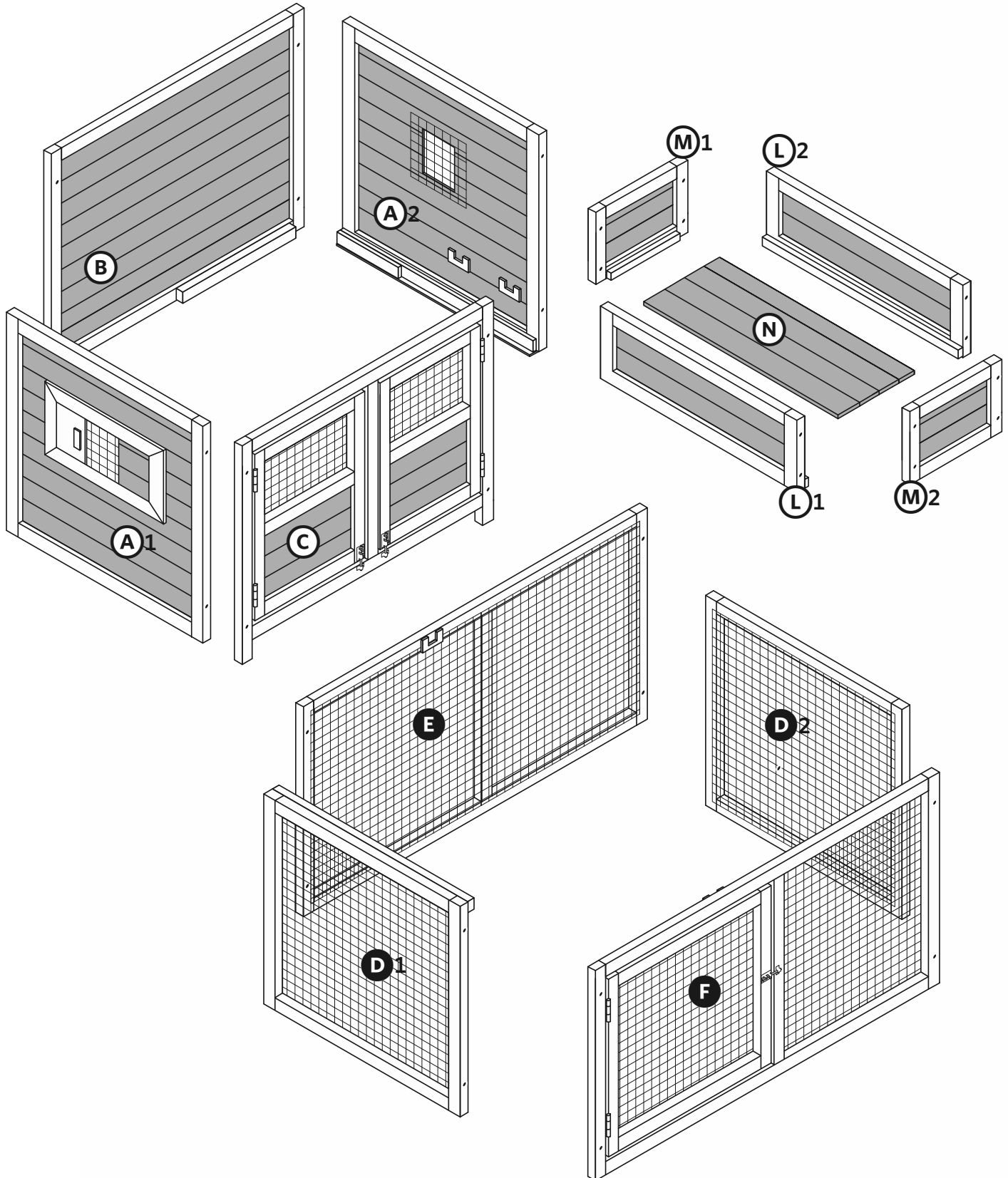



MODEL #4701 Chicken Coop with Herb Planter

PARTS LIST

CUSTOMER SUPPORT

Please contact Prevue Pet Products:

PHONE 1 (312) 243-3624

ONLINE www.prevuepet.com

EMAIL customerservice@prevuepet.com

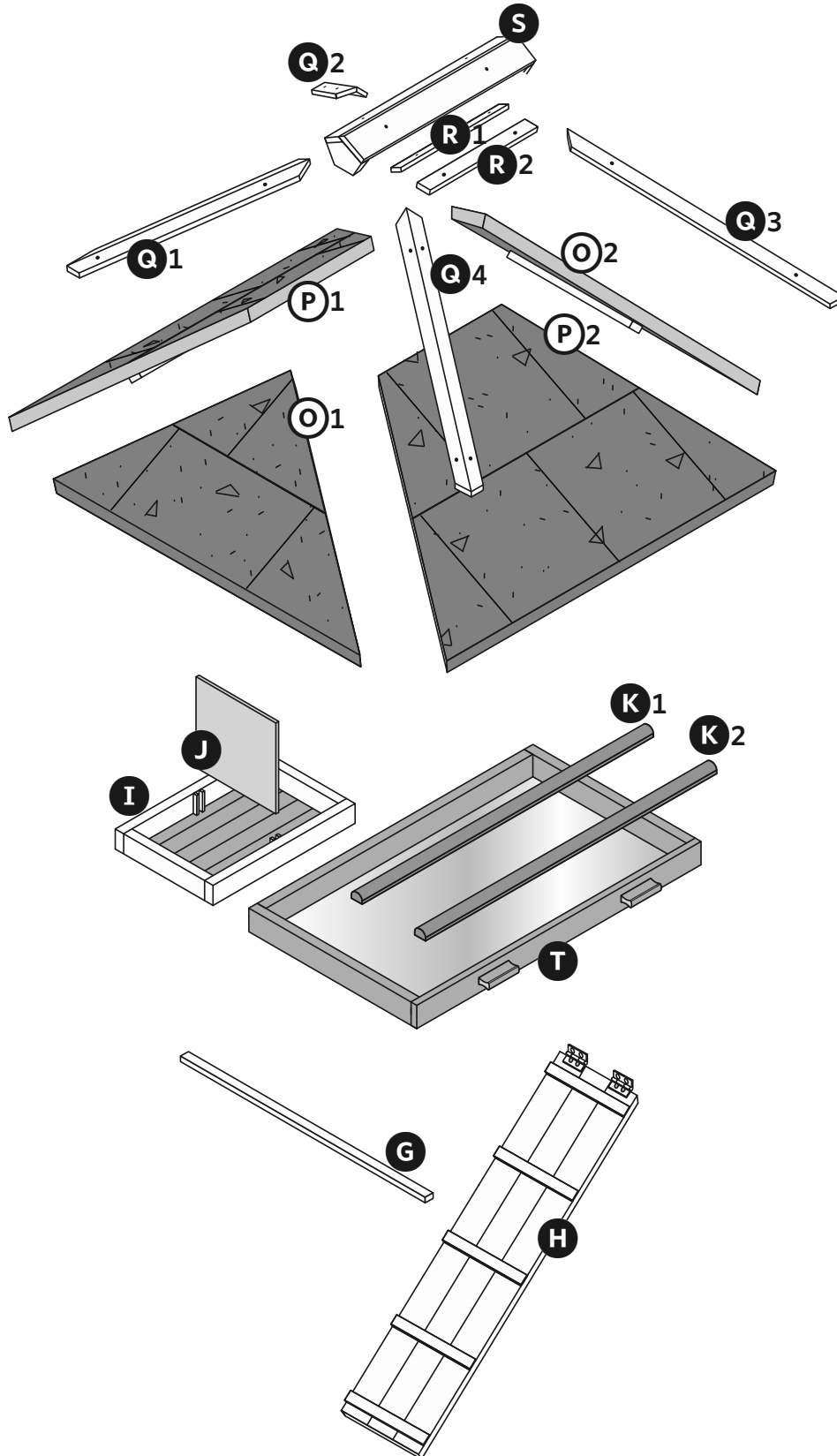

HARDWARE INCLUDED:

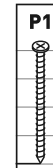

P1
2"L (50mm)
11 pcs +1
(use All in Step 2)



P2
1 3/4"L (45mm)
24 pcs +1
(use All in Step 1)

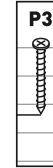

P3
1 3/8"L (35mm)
6 pcs +1
(use All in Step 4)

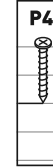

P4
1"L (25mm)
24 pcs +1
(use All in Step 4)



P5
5/8"L (16mm)
4 pcs +1
(use All in Step 3)

TOOLS REQUIRED:



**Screwdriver
or power drill
with
Phillips head
end/bit**

Chicken Coop with Herb Planter

2-3 Hens

Model: #4701 Instructions online at www.prevuepet.com

CUSTOMER SUPPORT

Please contact Prevue Pet Products:

PHONE 1 (312) 243-3624

ONLINE www.prevuepet.com

EMAIL customerservice@prevuepet.com

1 Assemble the COOP HOUSE. You will need these pieces:

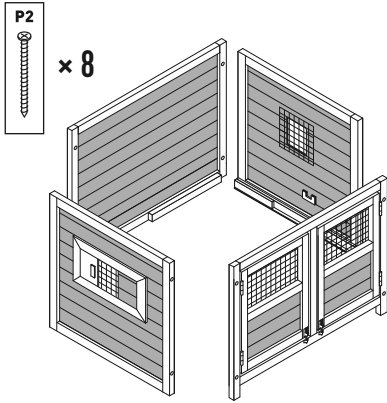

PLEASE READ:
 Align the right side coop house panel FLUSH ALONG THE TOP EDGE with the front & back panels.

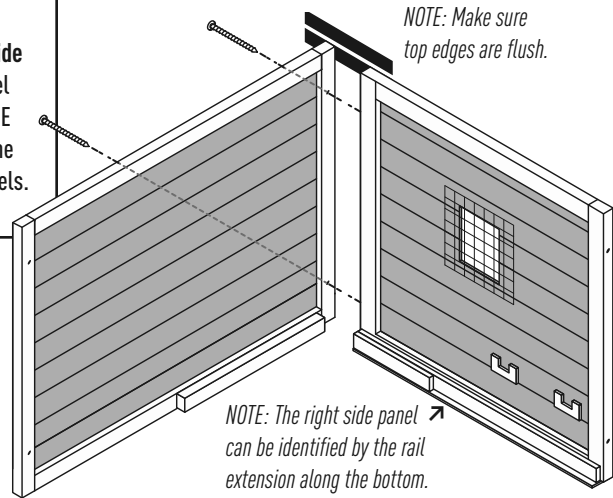

Attach the back panel to the right panel with [P2] screws, using the pre-drilled holes as guides.

Attach the remaining panels, also with [P2] screws.

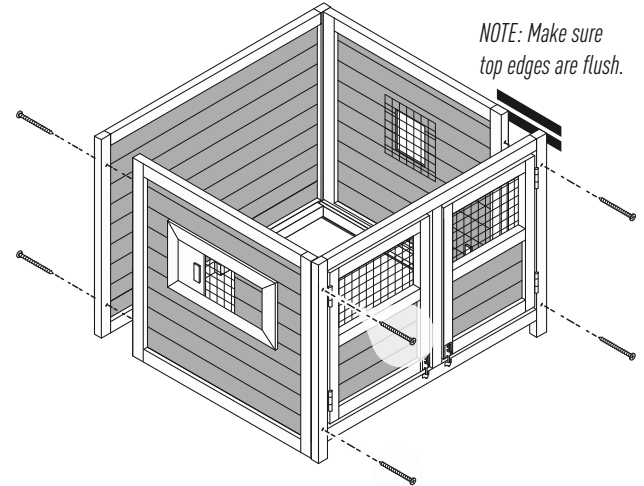

Assemble the PLANTER BOX. You will need these pieces:

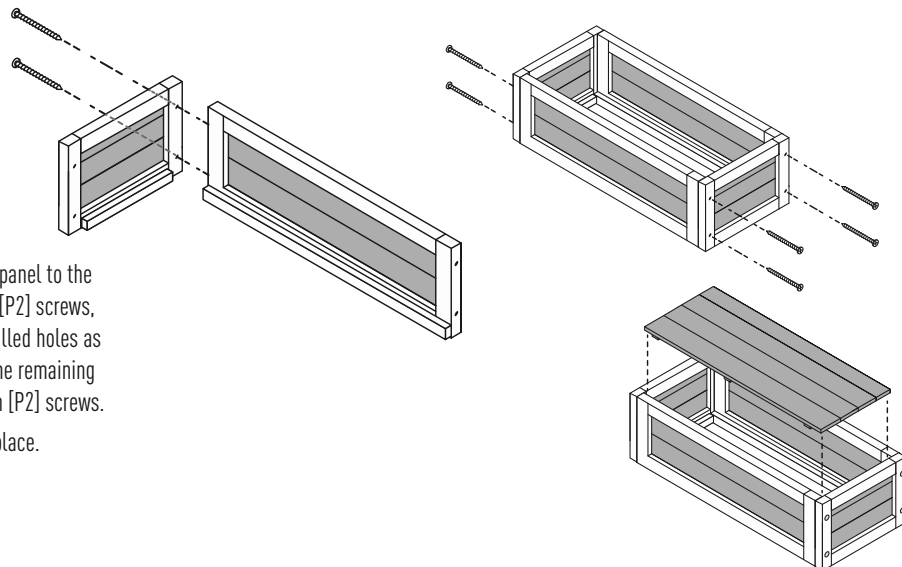
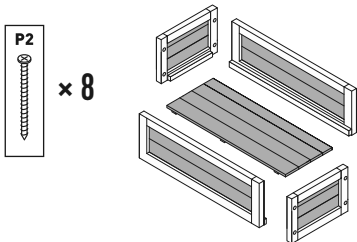

Attach the back panel to the right panel with [P2] screws, using the pre-drilled holes as guides. Attach the remaining panels, also with [P2] screws.
 Set the floor in place.

1 ...continued

Assemble the **CHICKEN RUN**.
You will need these pieces:

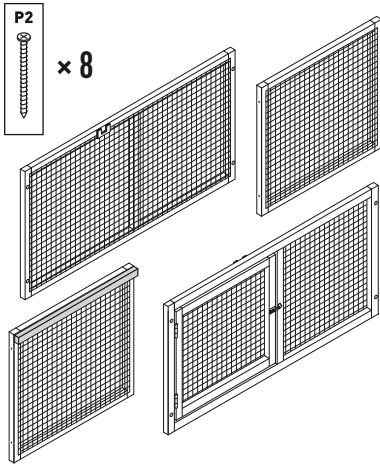

Attach the back panel to the right panel with [P2] screws, using the pre-drilled holes as guides. Attach the remaining panels, also with [P2] screws.

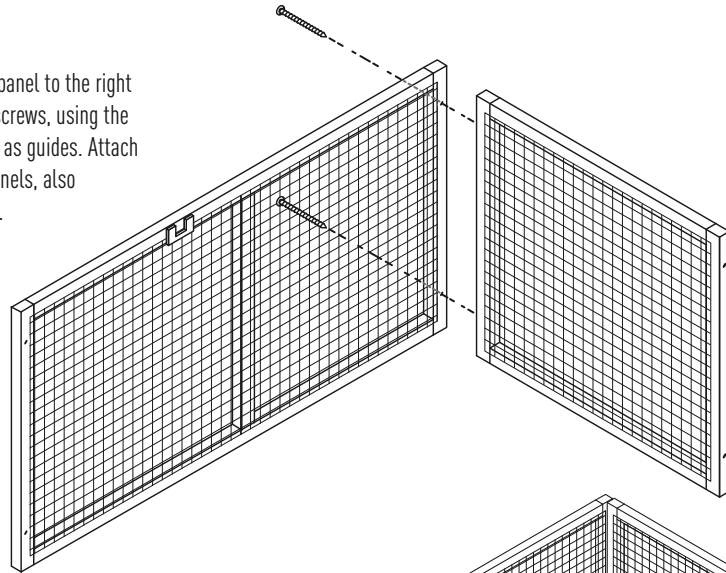

NOTE: The left side panel can be identified by the rail extension along the top edge. ↘

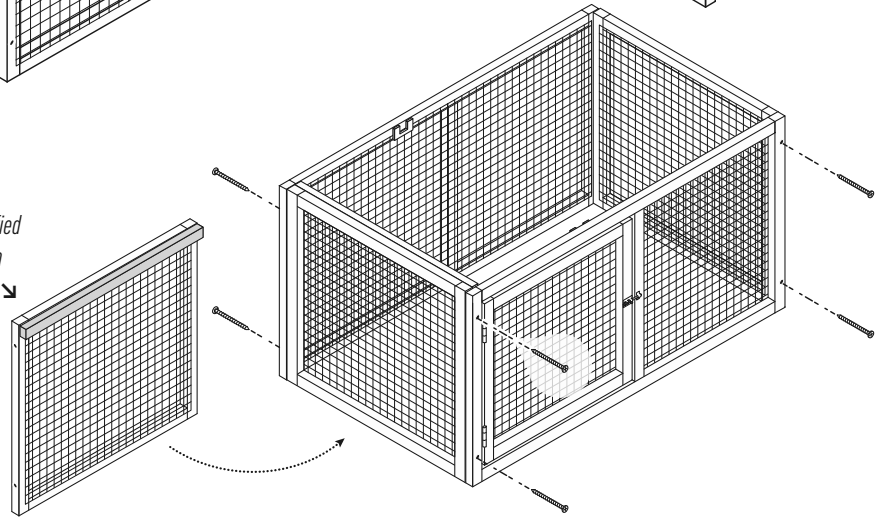

2 Attach the assembled units together:

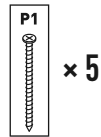
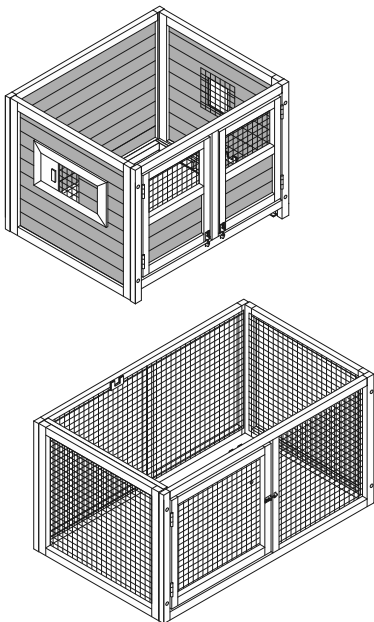

Set the coop house on the left end of the chicken run. Locate the pre-drilled holes on the underside of the frame rails. Attach the chicken run to the coop house with [P1] screws up through the pre-drilled holes.

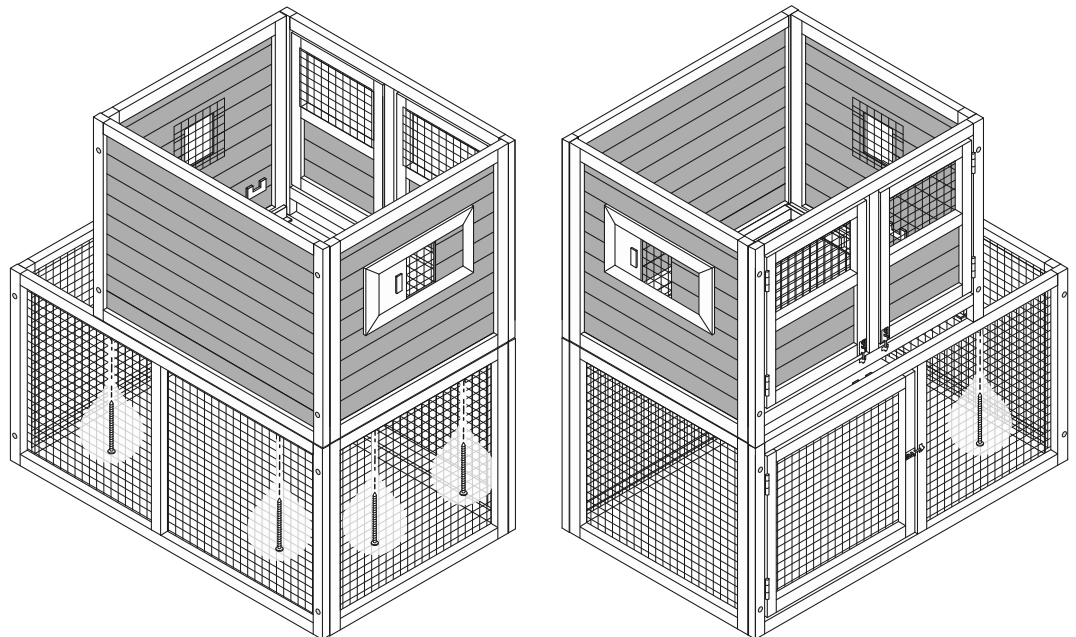

2 ...continued

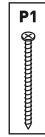
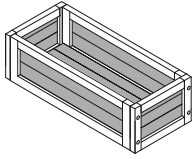

× 6

Set the herb planter box on the right end of the chicken run.
Locate the pre-drilled holes on the underside of the frame rails.
Attach with [P1] screws.

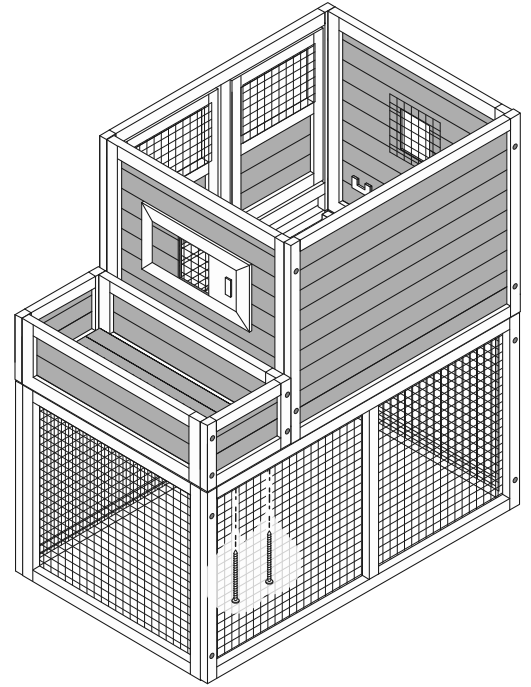
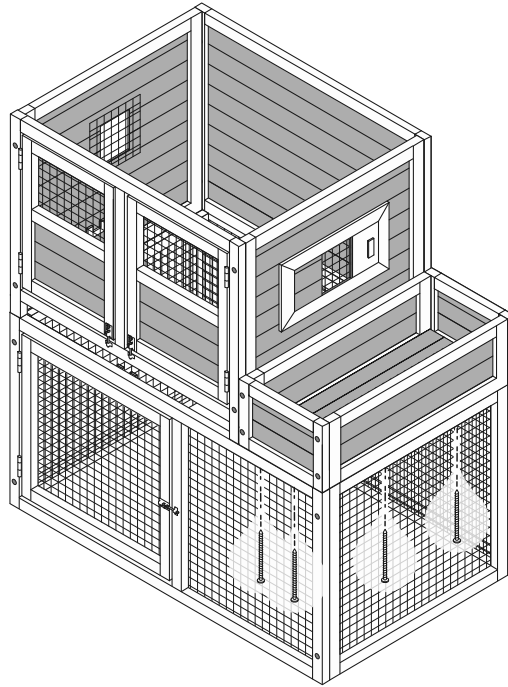

3 Install the COOP COMPONENTS in this order:

RAMP &
SUPPORT BAR



× 4

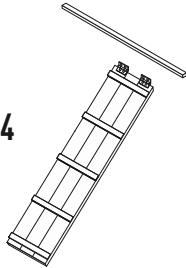

NESTING
TRAY

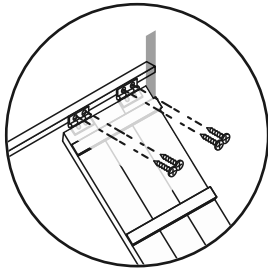
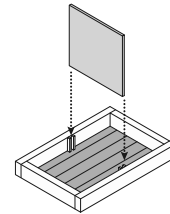

Leave about a 3/4" gap from the end of the bar to the ramp.
Attach the ramp to the support bar with [P5] screws.

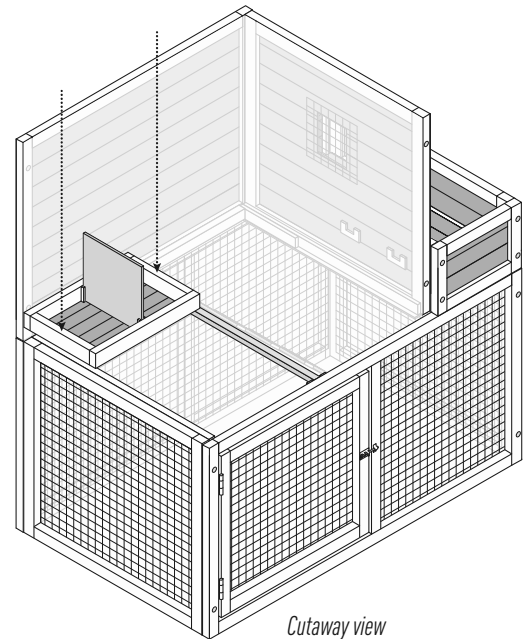
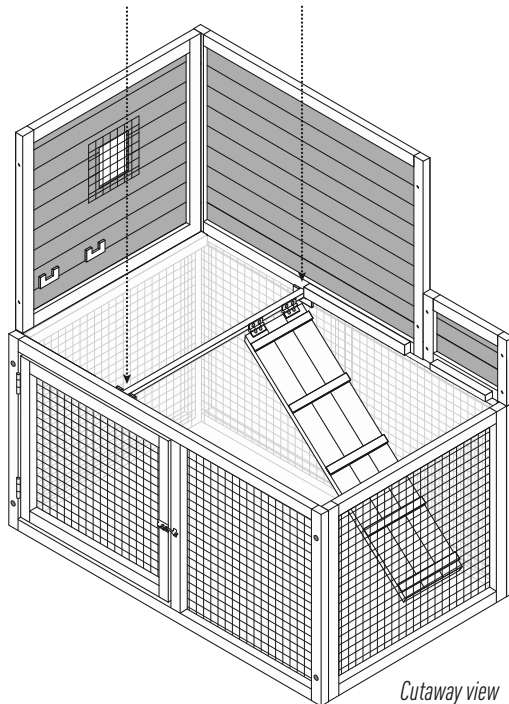

3

...continued

PERCH
BARS

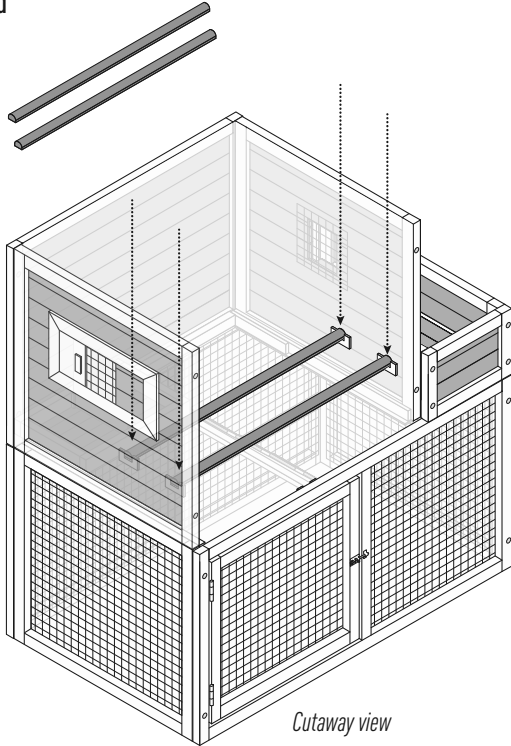

Cutaway view

COOP FLOOR
TRAY

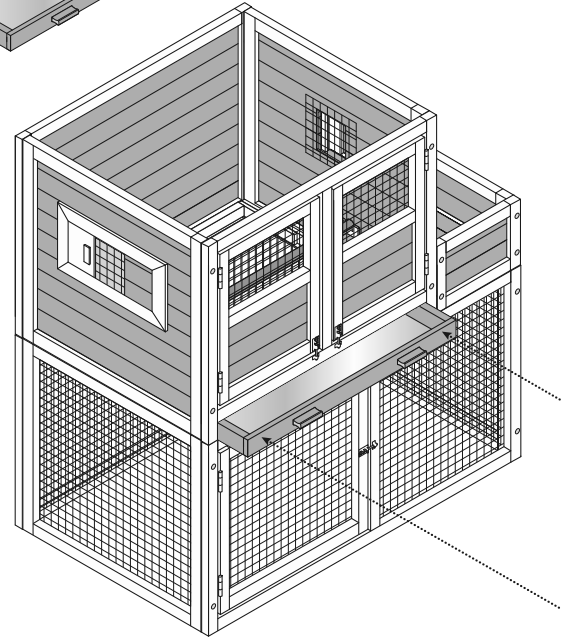
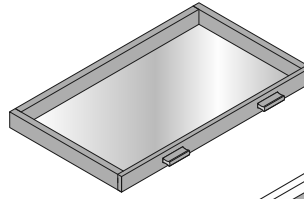

4

Assemble the **ROOF**. You will need these pieces first:

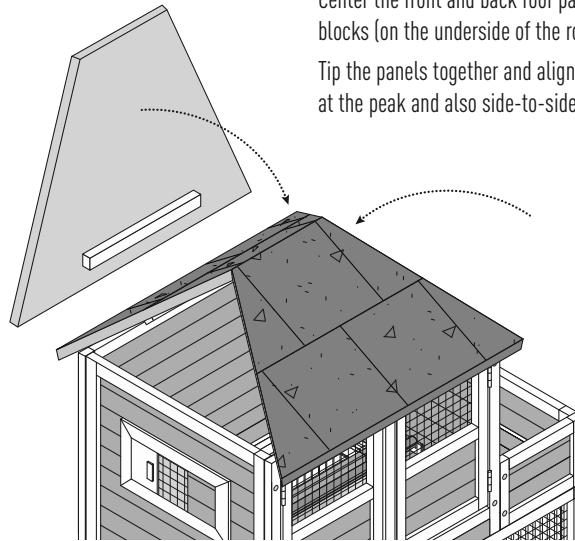
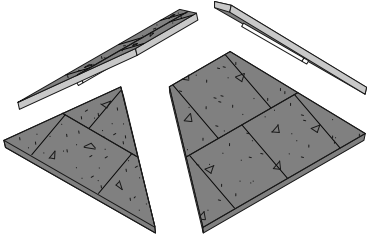

Center the front and back roof panels over the coop house. Catch the blocks (on the underside of the roof) onto the top of the coop house frame.

Tip the panels together and align them with your hands so they are flush at the peak and also side-to-side.

Tip the left side and right side roof panels into place.

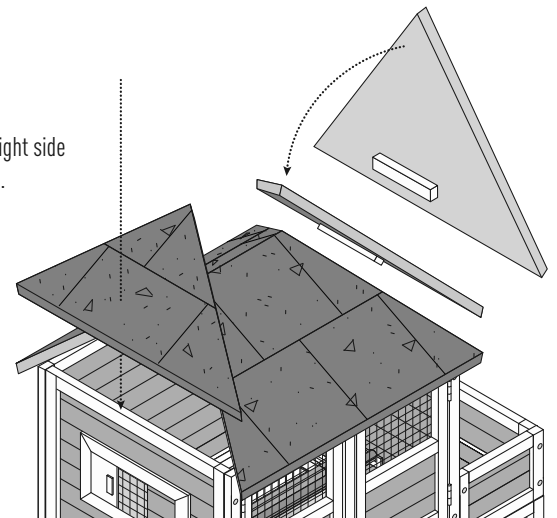

4

...continued

For the **ROOF TRIM**, you will need these pieces:

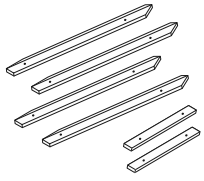

P4
× 20

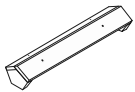

P4
× 4

P3
× 6

Lay the roof trim pieces in position.
Using the pre-drilled holes, attach the trim with [P4] screws.

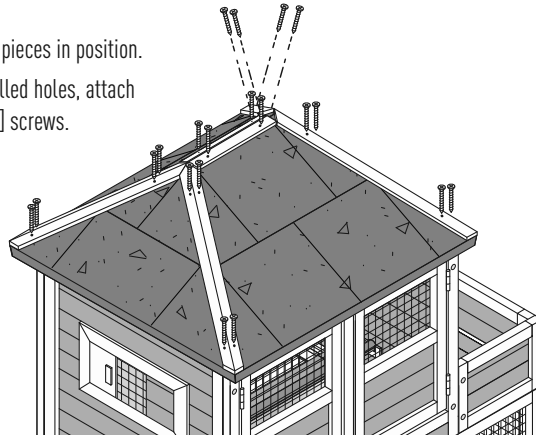

Lay the roof cap in position over the peak and attach with [P4] screws.

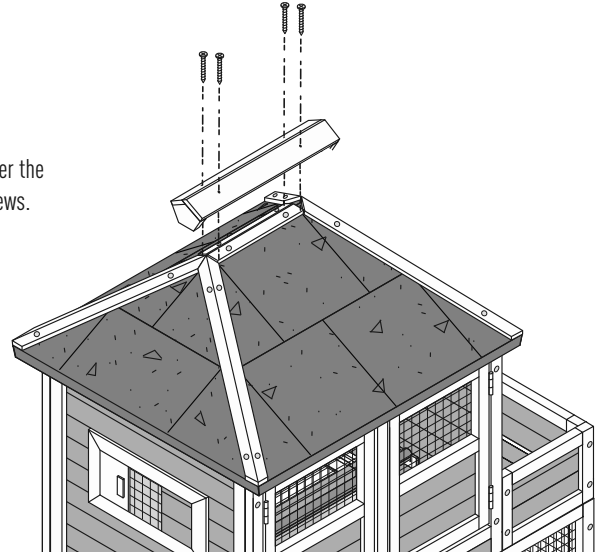

Using the pre-drilled holes, attach the entire roof unit to the coop house frame with [P3] screws.

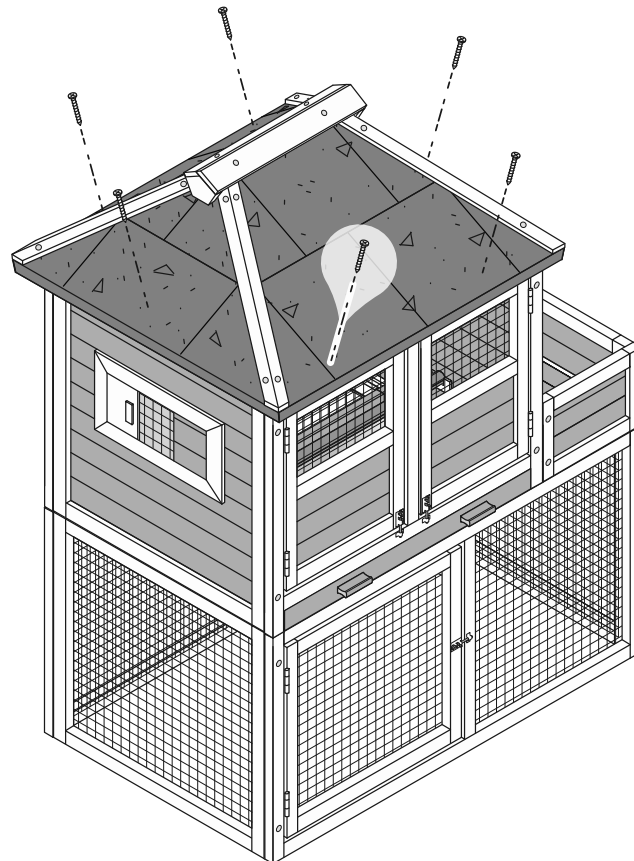

★
Your coop is now fully assembled and ready for use.