

# MAYNE<sup>®</sup>

BRING LIFE TO YOUR HOME & GARDEN

---







Left; Kobi Trough. See page 11

## ABOUT MAYNE

---

Founded in 2006, Mayne Inc. began by solely designing and manufacturing mail posts.

Since Mayne's inception, the company has grown significantly. We now design and produce a large line of outdoor décor, perfect for outfitting your home and garden.

We strive for excellence in all that we do. That's why we put our customers first, use high-quality material sourced from the United States and Canada, and back up our products with a 15-year residential warranty.



We're proud to offer quality products that are designed in Canada and made in the USA.





## FAIRFIELD COLLECTION

Classic inset panels and defined lines make the Fairfield Collection a timeless design.

- Offers the look of wood without the maintenance
- Contains a self-watering feature (residential sizes only)
- Built-in UV inhibitors prevent fading
- Thrives indoors and outdoors, year-round



**Fairfield Rectangle Planter**

#5826 | 36" L | 20" W | 20" H

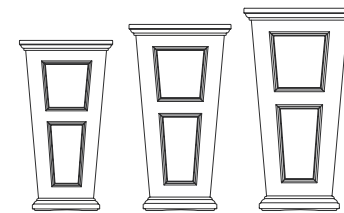

**Fairfield Tall Planters**

#5829	16" L	16" W	28" H
#8806	18.5" L	18.5" W	34" H
#8801*	22" L	22" W	40" H

\* 8800 & 8801 not available in graphite grey

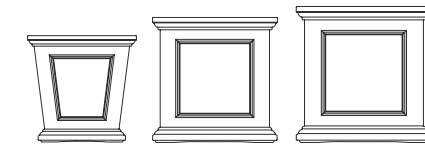

**Fairfield Square Planters**

#5887	16" L	16" W	16" H
#5825	20" L	20" W	20" H
#8800*	28" L	28" W	28" H





## FAIRFIELD COLLECTION

Classic inset panels and defined lines make the Fairfield Collection a timeless design.

- Offers the look of wood without the maintenance
- Built-in water reservoir helps plant growth
- Wall mount brackets included
- Corbels sold separately



### Fairfield Corbels 2pk

#5856 | 11" L | 4" W | 6.5" H

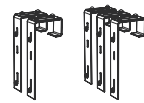

### Deck Rail Brackets

2pk #3832 | 3.8" L | 1.8" W | 9.5" H  
 3pk #3833 | 3.8" L | 1.8" W | 9.5" H

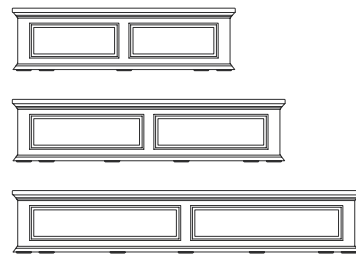

### Fairfield Window Boxes

#5822 | 36" L | 11" W | 11" H  
 #5823 | 48" L | 11" W | 11" H  
 #5824 | 60" L | 11" W | 11" H



## NEW

The Fairfield Patio Cooler doubles as a stylish side table and accent piece for your outdoor space. Equipped with a stainless steel bottle opener and bamboo cutting board, this fully insulated cooler is perfect for entertaining.

### Fairfield Cooler



#4862 | 20" L | 17" W | 20" H



### Fairfield Garden Hose Bin

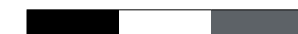

#5858 | 17" L | 17" W | 18" H



### Fairfield Waste Bin



#8874 | 22" L | 22" W | 40" H



### Fairfield Towel Valet



#8855 | 47" L | 20" W | 41" H





## VALENCIA COLLECTION



The Valencia Collection features a modern design with a subtle tulip shape.

- Constructed with a double wall for added durability
- Made from 100% high-grade polyethylene
- Built-in UV inhibitors prevent fading
- Window boxes contain self-watering feature

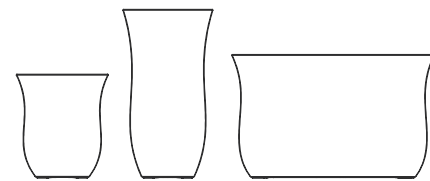

### Valencia Planters

#5873	16" L	16" W	18" H
#5874	16" L	16" W	30" H
#5875	36" L	16" W	22" H

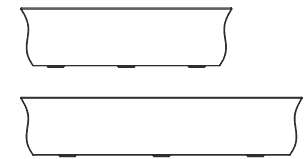

### Valencia Window Boxes

#5871	36" L	10" W	10" H
#5872	48" L	10" W	10" H







## MODESTO COLLECTION



A bold twist on a contemporary design, the Modesto Collection features an angled opening, grooved texture, and European elegance.

- Constructed with a double wall for added durability
- Made from 100% high-grade polyethylene
- Built-in UV inhibitors prevent fading
- Thrives indoors and outdoors, year-round

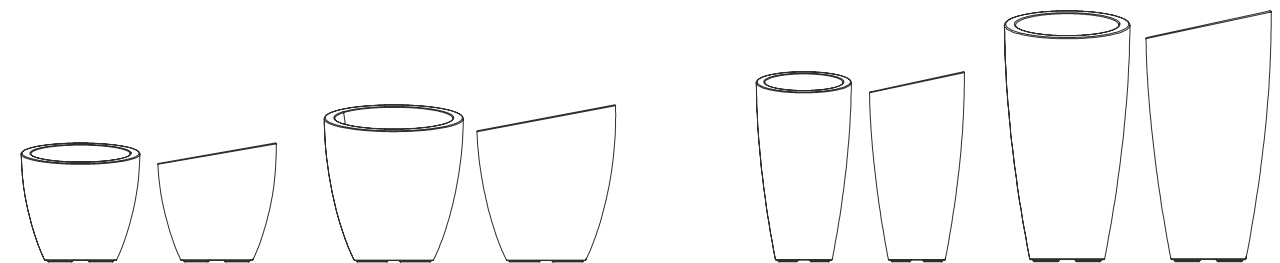

### Modesto Round Planters

#8879	20" L	20" W	20" H
#8884	30" L	30" W	34" H

### Modesto Tall Planters

#8880	16" L	16" W	32" H
#8881	22" L	22" W	42" H





## KOBI COLLECTION

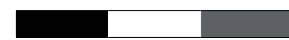

With its smooth exterior and straight lines, the Kobi Collection truly exemplifies modern sophistication.

- Constructed with a double wall for added durability
- Built-in water reservoir helps plant growth
- Built-in UV inhibitors prevent fading
- Thrives indoors and outdoors, year-round

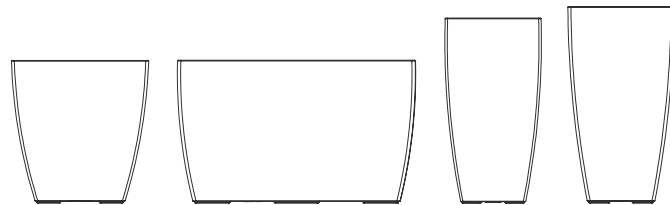

### Kobi Planters

#8889	24" L	24" W	24" H
#8836*	36" L	14" W	24" H
#8887	18" L	18" W	32" H
#8888	20" L	20" W	38" H

\*Lifestyle image of Kobi Trough on page 1







## KOBI COLLECTION

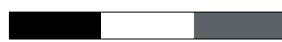

The Kobi Waste Bin has a smooth exterior and modern design. It's the ideal balance of style and durability.

- Made from 100% high-grade polyethylene
- Includes lightweight removable lid and liner
- Built-in UV inhibitors prevent fading
- Model #8842 comes with an inset stainless-steel ashtray

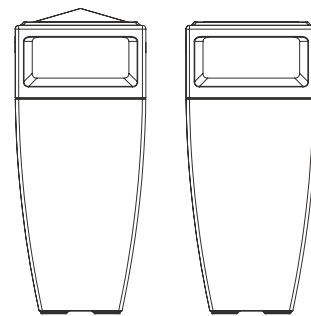

### Kobi Waste Bins

#8841	19" L	19" W	45" H
#8842	19" L	19" W	43" H







Classic panels and smooth lines make the Nantucket Collection both timeless and elegant.

- Made from 100% high-grade polyethylene
- Built-in water reservoir helps plant growth
- Built-in UV inhibitors prevent fading
- Thrives indoors and outdoors, year-round

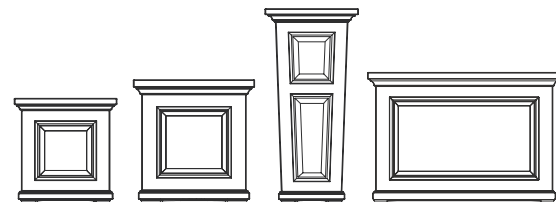

**Nantucket Planters**

#5865	16" L	16" W	16" H
#4846	20" L	20" W	20" H
#4833	16" L	16" W	32" H
#4847	36" L	16" W	24" H

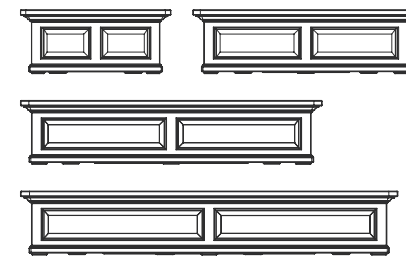

**Nantucket Window Boxes**

#4829	24" L	11.5" W	10" H
#4830	36" L	11.5" W	10" H
#4831	48" L	11.5" W	10" H
#4832	60" L	11.5" W	10" H



**Nantucket Corbels 2pk**

#4828	8" L	4" W	7" H
-------	------	------	------

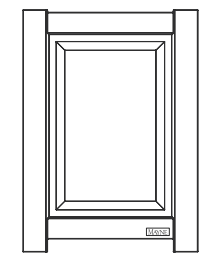

**Nantucket Privacy Panel**

#4850	34" L	2" W	47" H
-------	-------	------	-------





## LAKELAND COLLECTION

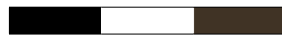

Achieve the perfect coastal style with the Lakeland Collection.

- Made from 100% high-grade polyethylene
- Contains a self-watering feature (residential items only)
- Built-in UV inhibitors prevent fading
- Thrives indoors and outdoors, year-round

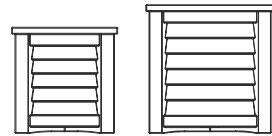

### Lakeland Square Planters

#5866 | 16" L | 16" W | 16" H  
 #5867 | 20" L | 20" W | 20" H



### Lakeland Towel Valet

#8872 | 23" L | 23" W | 66" H



### Lakeland Tall Planter

#5868 | 16" L | 16" W | 28" H



### Lakeland Waste Bin

#8871 | 22" L | 22" W | 38" H





## CAPE COD COLLECTION

Capture the sought-after New England feeling with the Cape Cod Collection.

- Features a beadboard panel design
- Built-in water reservoir helps plant growth
- Built-in UV inhibitors prevent fading
- Thrives indoors and outdoors, year-round

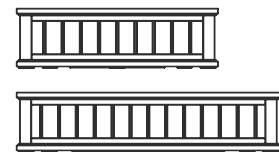

### Cape Cod Window Boxes

#4840	36" L	11" W	11" H
#4841	48" L	11" W	11" H

\* Optional Corbels available. Details on page 39  
 \* Lifestyle image on back cover



### Cape Cod Square Planters

#4839	24" L	11" W	11" H
#4836	14" L	14" W	14" H
#4837	16" L	16" W	18" H
#4838	20" L	20" W	20" H

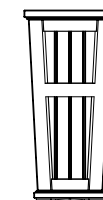

### Cape Cod Tall Planter

#4843	15.5" L	15.5" W	32" H
-------	---------	---------	-------





## BORDEAUX COLLECTION

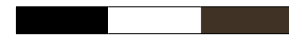

Strike the right balance between luxury and sophistication with the Bordeaux Collection.

- Made from 100% high-grade polyethylene
- Built-in water reservoir helps plant growth (model #5864 only)
- Built-in UV inhibitors prevent fading
- Thrives indoors and outdoors, year-round

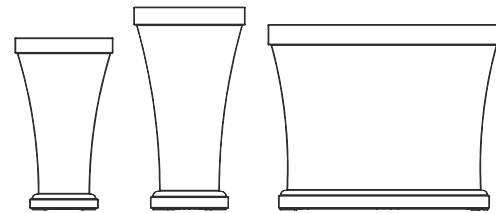

### Bordeaux Planters

#5864	16" L	16" W	28" H
#8802	22" L	22" W	40" H
#8890	40" L	15" W	32" H



Not only is the Bordeaux Waste Bin functional, but it also adds an architectural element to its surrounding. This bin comes with a base, removable lid & insert liner.

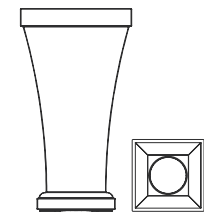
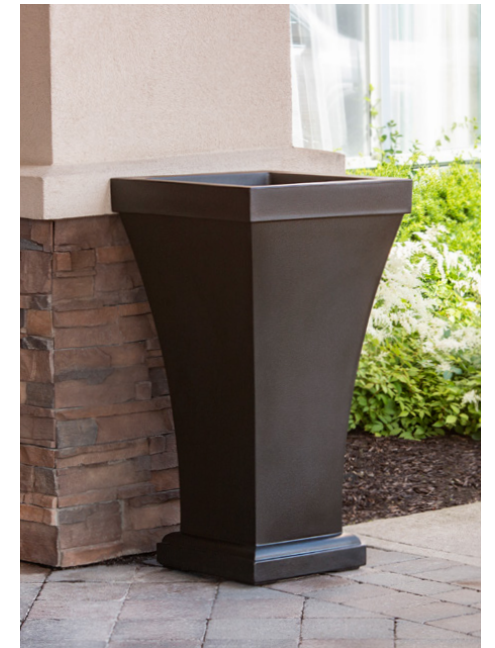

### Bordeaux Waste Bin

#8866	22" L	22" W	40" H
-------	-------	-------	-------





## ACADIA COLLECTION

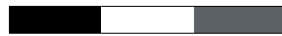

**Acadia Window Box**  
#5917 | 36" L | 11" W | 10" H

Create the feeling of modern elegance in your space with the Acadia Collection

- Constructed with a double wall for added durability
- Built-in water reservoir helps plant growth
- Built-in UV inhibitors prevent fading
- Thrives indoors and outdoors, year-round

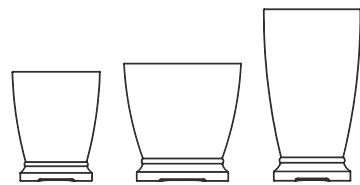

### Acadia Planters

#5915	14.5" L	14.5" W	18" H
#5920	20" L	20" W	20" H
#5916	16" L	16" W	28" H







## CAPRIO COLLECTION

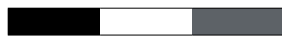

Sleek, round and modern. The minimalist style of the Caprio Collection is sure to brighten your space.

- Built-in water reservoir helps plant growth
- Made from 100% high-grade polyethylene
- Built-in UV inhibitors prevent fading
- For outdoor use only



### Caprio Planters

#5905	16" L	16" W	18" H
#5906	16" L	16" W	26" H



## CAMBRIDGE COLLECTION

Add a dynamic accent piece to your outdoor space with our elegant Cambridge Planters.

- Contains a self-watering feature
- Made from 100% high-grade polyethylene
- Built-in UV inhibitors prevent fading
- Thrives indoors and outdoors, year-round



### Cambridge Planter

#4870	15" L	15" W	18" H
-------	-------	-------	-------

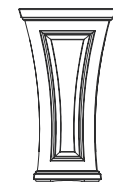

### Cambridge Tall Planter

#4834	16" L	16" W	28" H
-------	-------	-------	-------







## UNIQUE PLANTERS

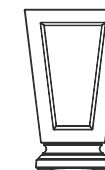

**Aberdeen Planter**



#5898 | 15" L | 15" W | 25" H

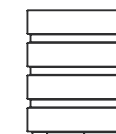

**Freeport Planter**



#5860 | 18" L | 18" W | 20" H



**Chelsey Planter**



#5883 | 16" L | 16" W | 28" H

Our planters are inspired by both modern and traditional designs, appealing to a wide range of style preferences.

- Built-in water reservoir helps plant growth
- Made from 100% high-grade polyethylene
- Built-in UV inhibitors prevent fading
- Backed by a 15-year residential warranty

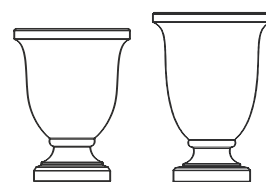

**Augusta Planters**



#5893 | 15.5" L | 15.5" W | 20" H  
#5894 | 18" L | 18" W | 26" H

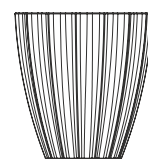

**Sedona Planter**



#2830 | 18" L | 18" W | 18" H







## UNIQUE PLANTERS

**Ellington Urn**  
#5896 | 15.6" L | 15.6" W | 24" H



**Georgian Planter** #5882 | 16" L | 16" W | 28" H



**Vienna Urn** #5892 | 16" L | 16" W | 25" H



**Versailles Planter**  
#5891 | 18" L | 18" W | 26" H



**Wyndham Planter**  
#5929 | 15.5" L | 15.5" W | 24" H



**Wellington Planter**  
#5863\* | 16" L | 16" W | 28" H  
*\*Built-in water reservoir doesn't apply*





## YORKSHIRE COLLECTION

Bring home East Coast charm with the low maintenance Yorkshire Window Box Collection.

- Made from high-quality vinyl
- Panels can be cut to custom lengths
- Built-in water reservoir helps plant growth
- Ready-to-assemble kit provided
- Only available in white but panels can be painted

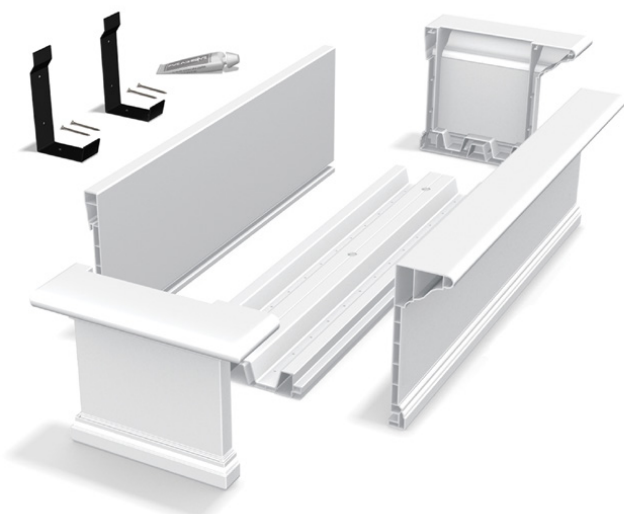

**Yorkshire Corbels 2pk**  
#4821 | 8" L | 4" W | 7" H

### Yorkshire Window Boxes

#4822	24" L	12" W	10" H
#4823	36" L	12" W	10" H
#4824	48" L	12" W	10" H
#4825	60" L	12" W	10" H
#4826	72" L	12" W	10" H
#8827	84" L	12" W	10" H
#8828	96" L	12" W	10" H

## RAIN CATCHER & STORAGE BINS



### Madison Rain Catcher

#5847 | 19.5" L | 22.5" W | 35" H

- 40-gallon water capacity
- Planting space 16.5" x 10" x 8"
- Includes overflow hose & 4' garden hose with shut-off valve



### Berkshire Storage Bin

#4835 | 20" L | 20" W | 38" H  
45-gallon storage capacity



### Mansfield Storage Bin

#5861 | 18" L | 14" W | 32" H  
22-gallon storage capacity



# LAMP POSTS

Light up your life with a Mayne lamp post. Our low maintenance polyethylene lamp posts are a great solution for your residential lighting needs.

- Lamp and wiring materials not included. Can be installed over an existing pipe.



**Liberty Lamp Post**  
#5838 | 9.5" L | 9.5" W | 72" H

**Liberty Lamp Post with Steel Mount**  
#5836 | 9.5" L | 9.5" W | 89" H



**Signature Lamp Post**  
#5837 | 9.5" L | 9.5" W | 72" H

**Signature Lamp Post with Steel Mount**  
#5835 | 9.5" L | 9.5" W | 89" H

# ADDRESS SIGNS

Enjoy the look of a wooden address sign without any of the upkeep with our line of address signs. They are low maintenance and can add a dash of elegance to just about any driveway.

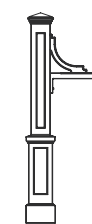

**Woodhaven Address Sign**  
#5812 | 22.5" L | 8" W | 56.5" H

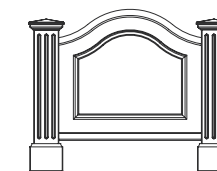

**Nantucket Address Sign**  
#5820 | 7" L | 40" W | 31.5" H



Our Mail Post Collection has a timeless design that will never go out of style and is a surefire way to add curb appeal to your front lawn.



4X4 WOOD POST, MAILBOX, AND MAILBOX MOUNTING HARDWARE NOT INCLUDED WITH ANY MAYNE MAIL POST.

## MAIL POST COLLECTION

See page 39 for mail post accessories

**Dover**  
#5810 | 25.5" L | 8" W | 56.5" H



**Liberty** #5805 | 31" L | 14" W | 64" H



**Westbrook Plus** #5830 | 40" L | 8" W | 56.5" H



**Newport Plus**  
#5813 | 25" L | 8" W | 56.5" H



**Charleston**  
#5857 | 25.5" L | 9" W | 58" H



**Charleston Plus**  
#5846 | 26" L | 9" W | 58" H





# MAIL POST COLLECTION

See page 39 for mail post accessories

**Signature Plus**  
#5808 | 40.5" L | 8" W | 56.5" H



**Manchester** #5852 | 26" L | 9" W | 58" H



**Rockport Single**  
#5809 | 18" L | 15.5" W | 56.5" H



**Rockport Double**  
#5811 | 18" L | 23" W | 56.5" H



**Newport Plus Double**  
#5814 | 8" L | 41" W | 56.5" H





# ACCESSORIES

Mayne hardware includes a 1 year limited warranty. For warranty claims please contact our customer service team at [customerservice@gomayne.com](mailto:customerservice@gomayne.com)



**No-dig Ground Anchor**  
580D | 4" L | 3" W | 27" H



**Adjustable Deck Rail Brackets**  
2pk #3832 | 3.8" L | 1.8" W | 9.5" H  
3pk #3833 | 3.8" L | 1.8" W | 9.5" H



**Mail Post Solar Cap**  
LZM-625 | 6.5" L | 6.5" W | 4.5" H



**Address Sign Arm**  
MP5818 | 19" L | 5" W | 19" H

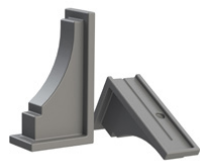

**Fairfield & Cape Cod Corbels 2pk**  
#5856 | 11" L | 4" W | 6.5" H



**Yorkshire Corbels 2pk**  
#4821 | 8" L | 4" W | 7" H

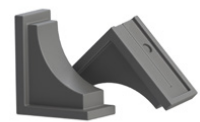

**Nantucket Corbels 2pk**  
#4828 | 8" L | 4" W | 7" H



Newport Plus Mail Post. See page 36



# CUSTOM DESIGNS

---

Great design means great products. At Mayne, design is at the heart of everything we do. Partner with us to create a product that defines the next big trend or let us help you develop your own ideas.

Our in-house design team specializes in creating outdoor décor products. We focus on products that are functional, stylish, and aesthetically pleasing. We do this by taking the time to consider how a product will be used, the environments it will be exposed to, and its expected life cycle.

From concept to creation, we're here to bring ideas to life. Interested in a custom design? Connect with our sales team at [sales@gomayne.com](mailto:sales@gomayne.com).

# COLOR SCHEME

---

Our standard line is made up of classic colors that will never go out of style. Outfit your space with these standard colors to create a timeless look or work with us to create a custom color to give your space a modern twist. Minimum order quantities are required for custom colors.



# MAYNE COMMERCIAL

---

Mayne Inc. is proud to serve the business community with high-end quality products perfect for your business. We've designed a line of planters, towel valets, waste bins, and mail posts ideal for outfitting your commercial property.

Whether you own a small shop or a large hotel, we have the right products to elevate your space.

Some of our key partnerships include:

## Hotels

Make your guests feel welcome by adding Mayne planters to your lobby or adding a Mayne towel valet to your pool area. Our standard color palette includes black, white, espresso and graphite grey. These classic neutral colors add a little something extra to your hotel all while matching your current aesthetic. Looking for a statement piece in a more adventurous color? Not a problem - Reach out to us and we can work together on creating something that is uniquely you!

## Homeowner Associations

We understand the importance and value of curb appeal. That's why we're thrilled to offer an extensive line of mail posts for your neighborhood. Mayne Mail Posts are proudly made in the US. Going for a classic look? Our Signature Plus Mail Post is a fantastic option. Looking for something more contemporary? Then our Manchester Mail Post might just be what you are looking for.

## Design Firms

We believe that products should not only be beautiful but also durable. Our planters are made from 100% high-grade polyethylene, making them lightweight and strong. Designers don't need to choose between style and sturdiness anymore - they can have both with Mayne products.

Are you a business owner interested in learning more? Reach out to us at [sales@gomayne.com](mailto:sales@gomayne.com)





**Cape Cod Window Boxes**

#4840	36" L	11" W	11" H
#4841	48" L	11" W	11" H

# MAYNE®

**HEAD OFFICE**

7024 Kilbourne Road, Unit A, London, Ontario N6P 1K6 Canada

**PRODUCTION FACILITY**

500 W. Main Street, Alliance, Ohio 44601 United States

[gomayne.com](http://gomayne.com) | [sales@gomayne.com](mailto:sales@gomayne.com)