

Hessaire Warranty

Each new cooler is warranted to be free from defects in material or workmanship for one full year from the date of original purchase. If a component(s) is found to be defective within this period, a Hessaire representative will replace the defective part free of charge. Parts are available through authorized dealers or online. Copy of proof of purchase and serial label will be needed for the warranty claim.

What is not covered:

Malfunctions resulting from misuse, negligence, alteration or lack of necessary maintenance.

Loss of time, inconvenience, use of product or other consequential damages due to defects.

Return transportation costs. All return costs are the responsibility of the purchaser.

Hessaire does not cover labor costs associated with troubleshooting or cooler repairs regardless if the product is under warranty or not.

Damaged Shipments:

Hessaire is not responsible for damaged shipments or shortages resulting from carrier mishandling. Notify your carrier's office immediately to file a freight claim in the event of damage. Keep damaged product for inspection until advised by carrier as to disposal.

Returns:

Hessaire's dealers shall implement a return policy that is consistent with the dealer agreement. If the dealer's return policy allows returns within a specified time period—agreed to by Hessaire and dealer, customer may return product to point of purchase. Dealer may reject, accept or accept with a restocking fee at the sole discretion of the dealer. If the customer wishes to repair the defective cooler, the customer can contact Hessaire for a list of authorized repair centers for parts and troubleshooting. Defective parts are provided free of charge within the warranty period.

Please DO NOT return your cooler to Hessaire. Upon authorization, any returns should be sent directly to the distributor/store where purchased.

Visit hessaire.com for registration & warranty claim forms.



Mobile Evaporative Cooler

11000 CFM

Use & Care Guide

MC92V, M350

INDEX

Safety Rules.....	1
Quick Start.....	2
Features.....	3
Maintenance.....	4
Troubleshooting....	5
Cooler Parts.....	6
Warranty.....	7



General Safety Precautions



Read and follow all instructions, cautions and warnings. Failure to do so could result in personal injury, death or property damage.

Unit must be in **OFF** position and **UNPLUGGED** from power receptacle before performing any maintenance / service or before **REMOVING** access panels.

Make sure the electrical power source conforms to the requirement of the evaporative cooler as well as local codes.

To reduce risk of fire or electrical shock, do not expose electrical connections to water.

Do not touch electrically live components.

Ensure all power cords do not touch sharp edges, hot surfaces or chemicals. Immediately replace damaged parts.

Never leave unit unattended.

Continuous fill not to be used indoors or unattended.

Operation Tips

Hessaire coolers are highly recommended for outdoor use. If used indoors, position cooler in front of window or open door for fresh intake air. Ensure there is an open door or window through which the air can exhaust from the room.

Clean media pads and tank frequently.

When shutting down unit, run without pump for 30 minutes to properly dry media pads.

Prior to long term storage:

Drain tank and wipe clean

Dry and clean rigid media pads

Indoor Use

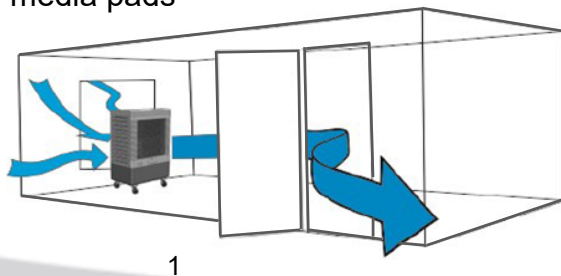

Cooler Parts

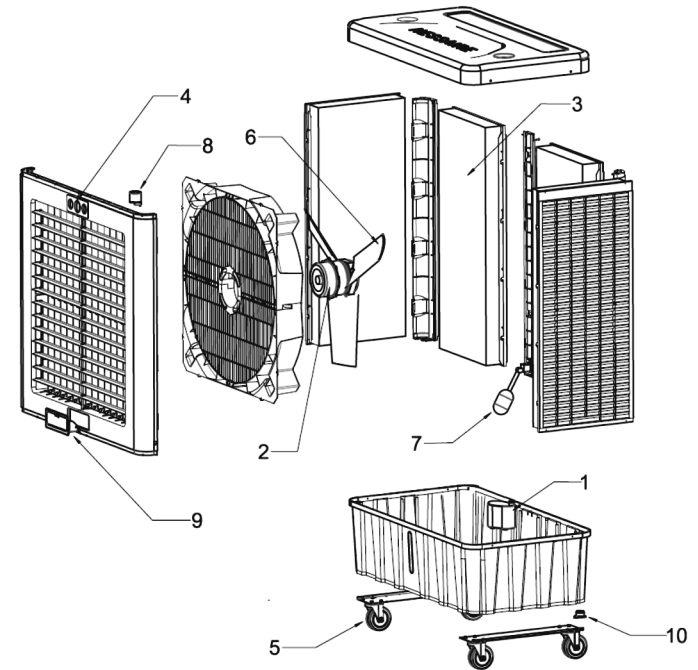

#	Parts	MC92V / M350
1	Pump	6091050
2	Motor	6092000
3	Rigid Media Set	CP900
4	Control	6092069
5	Caster Set (4 pcs)	6186100
6	Fan Blade	9001561
7	Float Valve Kit (float valve, hose adapter)	6018058
8	Oscillator Motor	6091057
9	Manual fill door	6092076
10	Drain plug	6017081



Troubleshooting

Problem	Cause / Remedy
Cooler won't turn on	Ensure unit is plugged in and switched on. Receptacle breaker may need to be reset. If unit is equipped with a GFCI plug, reset. If unit has a timer, ensure it is off. May need new ON/OFF switch.
Fan will not operate	Ensure fan function is on. Make sure nothing is obstructing fan blade. Fan motor may need to be replaced. Fan switch may need to be replaced. Slow running - may need capacitor replaced.
Cooler does not pump	Ensure pump switch is turned on. Make sure water level is not low. Add water. Make sure hoses are connected and free of debris. Pump may need to be replaced. Pump switch may need to be replaced.
Swing does not work	Ensure swing switch is turned on. Make sure the linkage is connected. Oscillation switch may need to be replaced. Oscillation motor may need to be replaced.
Water leakage	Make sure drain plug is securely in place. Make sure cooler is level. Inspect tank for cracks. Check media pads for water running on outside of unit. Change pads if necessary. Check for leaks in water distribution hose connections. Check spreaders for build up causing spill over of water into the airstream.
Water level high or low	Adjust nut on float valve. Float valve may need to be replaced.

Inspection

After unpacking your cooler, carefully inspect for any damage that may have occurred during transit. Inspect for loose, missing or damaged parts. *Note: wheels & hardware are located inside the cooler tank. Remove back panel to locate.*

Contents: Evaporative Cooler (1), Hardware Bag/Hose Adapter (1), Caster Wheels (4).

Visit Hessaire.com to request replacement parts if any of these items are missing.

Quick Start

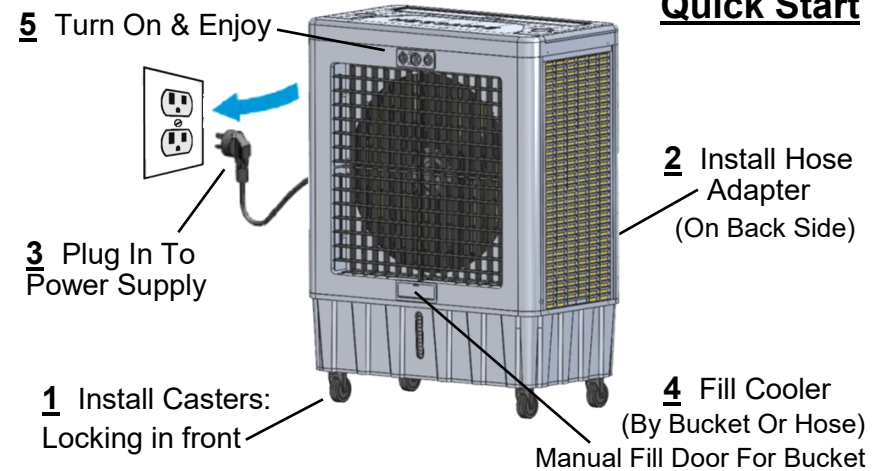

Note: Media pads may have a slight odor upon initial start up but will go away with continued use.

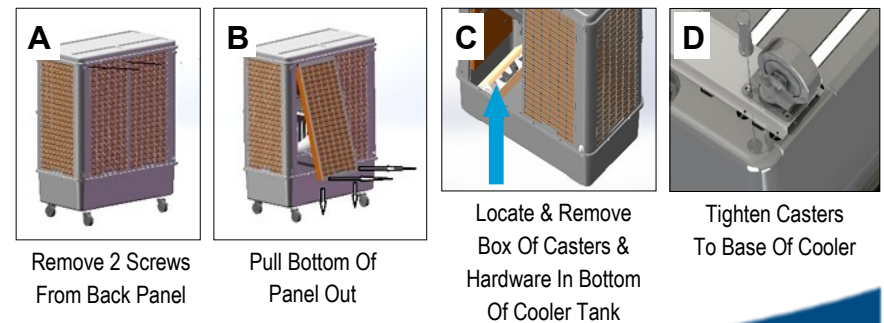



Features

Control Panel For MC92V, M350

Switch for Fan Speeds: 4 Positions (OFF, LOW, MED, HIGH)

Switch for Pump: ON/OFF

Switch for Swing (oscillation): ON/OFF

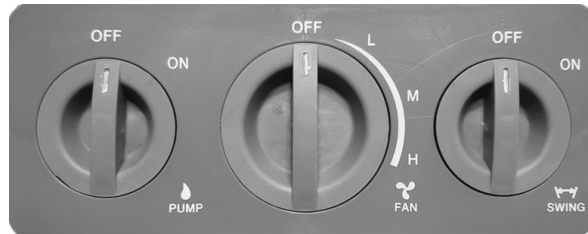

Convenient Top Flat Storage Area



Manual Fill Option
Door Front Center
On Cooler



Continuous Water
Feed Hose Adapter
Back Side Of Cooler

Maintenance

⚠ WARNING Disconnect from power source before attempting any maintenance or routine service. NEVER remove any access panels while cooler is in operation. Failure to do so could lead to **SERIOUS INJURY**.

Cleaning Cooler & Rigid Media Pads:

The removable panel(s) & pads can be gently sprayed off to remove build up. A soft bristle brush can also be used.

NEVER spray pads with water while cooler is in operation. Damage can occur to the motor and will void the warranty.

Note: Vinegar is recommended for cleaning of cooler and can be periodically cycled through during normal use.

Removal Of Back Panel:

Disconnect power supply. Remove phillips screws from the upper back side of cooler.

Push panel up and pull bottom out to remove.

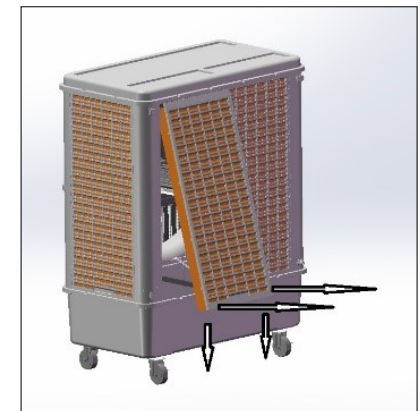
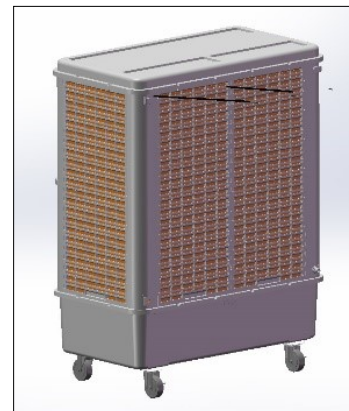

Storage:

Drain tank and wipe dry. Plug is located on bottom of cooler. Ensure pads are dry by running fan without pump for at least 30 minutes.

Visit Hessaire.com for additional maintenance tips and service videos.