

# Installation Instructions

I - Sheet Number I-PW007092 Rev. A



Premium Style. Lasting Performance.

For proper installation and best possible fit, please read all instructions BEFORE you begin.  
For technical assistance or to obtain missing parts, please call Customer Relations at 1-800-241-7219.

Para una instalación adecuada y el mejor ajuste posible, lea todas las instrucciones ANTES de comenzar.  
Para obtener asistencia técnica o para obtener piezas que faltan, por favor llame a Relaciones con el cliente en 1-800-241-7219.

Pour une installation correcte et le meilleur ajustement possible, s'il vous plaît lire toutes les instructions AVANT de commencer.  
Pour une assistance technique ou pour obtenir des pièces manquantes, s'il vous plaît communiquer avec les Relations à la clientèle au 1-800-241-7219.

## Care and Cleaning

- **Wash only with mild soap & dry with a clean cloth.**  
Lavar con jabón suave y seque con un paño limpio.  
Laver avec un savon doux et séchez avec un chiffon propre.
- **Every 3 months or 5000 miles check the cover tension and all components for tightness.**  
Revise cada 3 meses o 5,000 millas la tensión de la cubierta y todos los componentes estén ajustados.  
Vérifiez tous les 3 mois ou 5000 miles la tension couvercle et le serrage des composants.

## Congratulations!

You have purchased one of the many quality Lund® branded products offered by Lund International, Inc. We take the utmost pride in our products and want you to enjoy years of satisfaction from your investment. We have made every effort to ensure that your product is top quality in terms of fit, durability, finish and ease of installation.

Usted ha comprado uno de los muchos productos de calidad ofrecidos por Lund® de marca productos ofrecidos por Lund International, Inc. Tomamos el orgullo extremo en nuestros productos y queremos que disfrute durante años de su inversión. Hemos hecho todos los lo posible para que su producto es de calidad superior en cuanto a ajuste, durabilidad, acabado y facilidad de la instalación.

Vous avez acheté un des nombreux produits de qualité offerts par Lund® marque produits offerts par Lund International, Inc Nous sommes extrêmement fiers de nos produits et souhaitons que vous tiriez des années de satisfaction de votre investissement. Nous avons pris toutes les efforts pour s'assurer que votre produit est de qualité supérieure en termes de durabilité, de finition et la facilité de l'installation.

# INSTALLATION INSTRUCTIONS

PART# 23882092/ 23782092

**IMPORTANT ALERT:** GM uses a very strong thread-locking compound on all body bolts. Use of an air assisted impact ratchet can cause damage to the threads on factory body mount bolts and the internal nut assembly because of this thread locking compound. We only recommend the use of hand tools to slowly remove and reinstall body mount bolts on all GM vehicles.

## PROCEDURE:

**CRITICAL INFORMATION:** If during the removal process, it becomes increasingly difficult to unscrew the body mount bolt with hand tools, tighten the bolt several rotations to clear the thread locking compound from the threads, then reverse direction and continue to unscrew until the body mount bolt is out. Repeat this process as necessary on all GM body mount bolts. Use of an appropriate anti-seize compound is highly recommended for re-installation. Tighten body mount bolt to factory torque specifications for your particular model year.

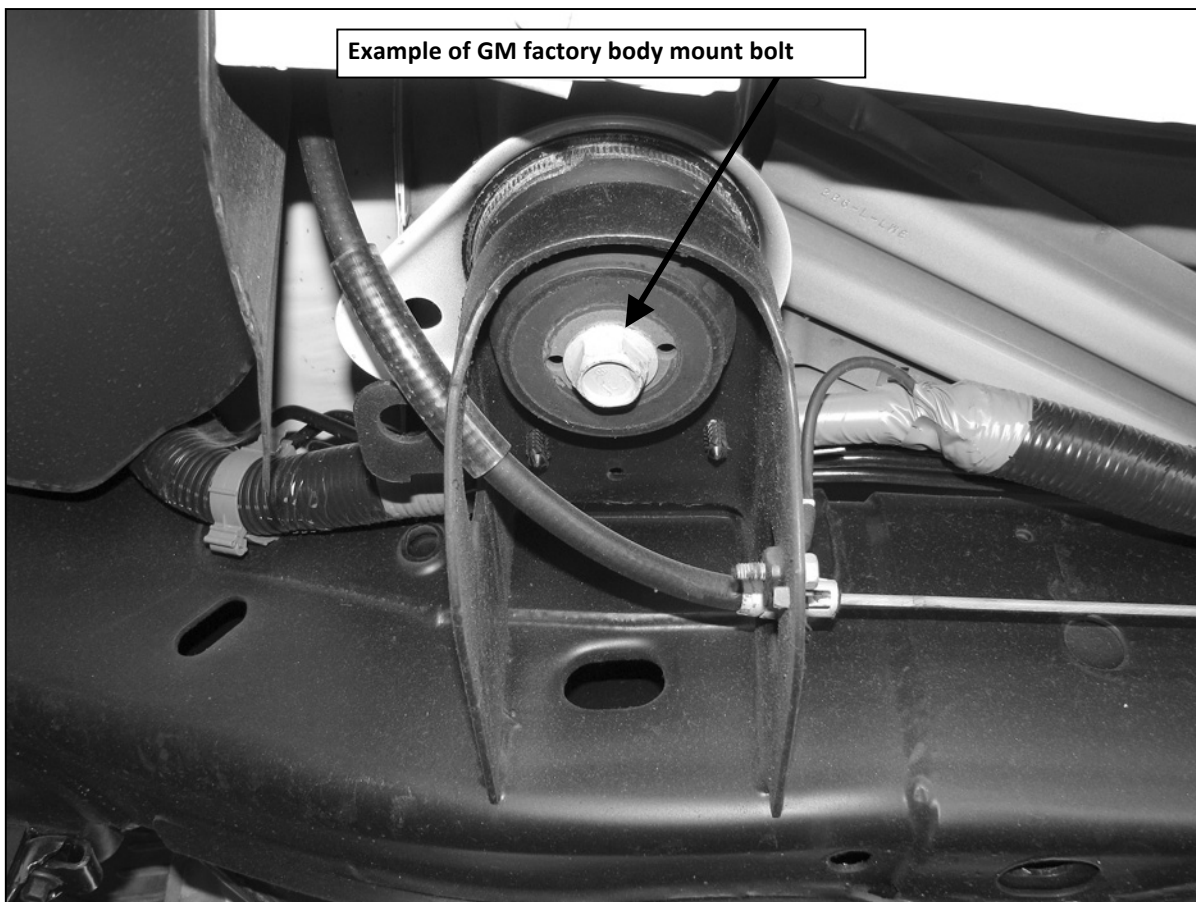

**PARTS LIST:**

1	Driver/Left Side Bar	4	12mm x 32mm x 3mm Flat Washers
1	Passenger/Right Side Bar	2	12mm Lock Washers
1	Driver/Left Front Mounting Bracket	2	12mm Hex Nuts
1	Passenger/Right Front Mounting Bracket	2	10mm Nut Plates
1	Driver/Left Side Center Mounting Bracket	6	10-1.50mm x 30mm Hex Bolts
1	Passenger/Right Side Center Mounting Bracket	10	10mm x 20mm OD x 2mm Flat Washers
1	Driver/Left Rear Mounting Bracket	6	10mm Lock Washers
1	Passenger/Right Rear Mounting Bracket	4	10mm Hex Nuts
1	Driver/Left Front Support Bracket	12	8-1.25mm x 25mm Hex Bolts
1	Passenger/Right Front Support Bracket	12	8mm ID x 24mm OD x 2mm Flat Washers
2	Center Support Brackets	12	8mm Lock Washers
2	12-1.75mm x 30mm Hex Bolts		

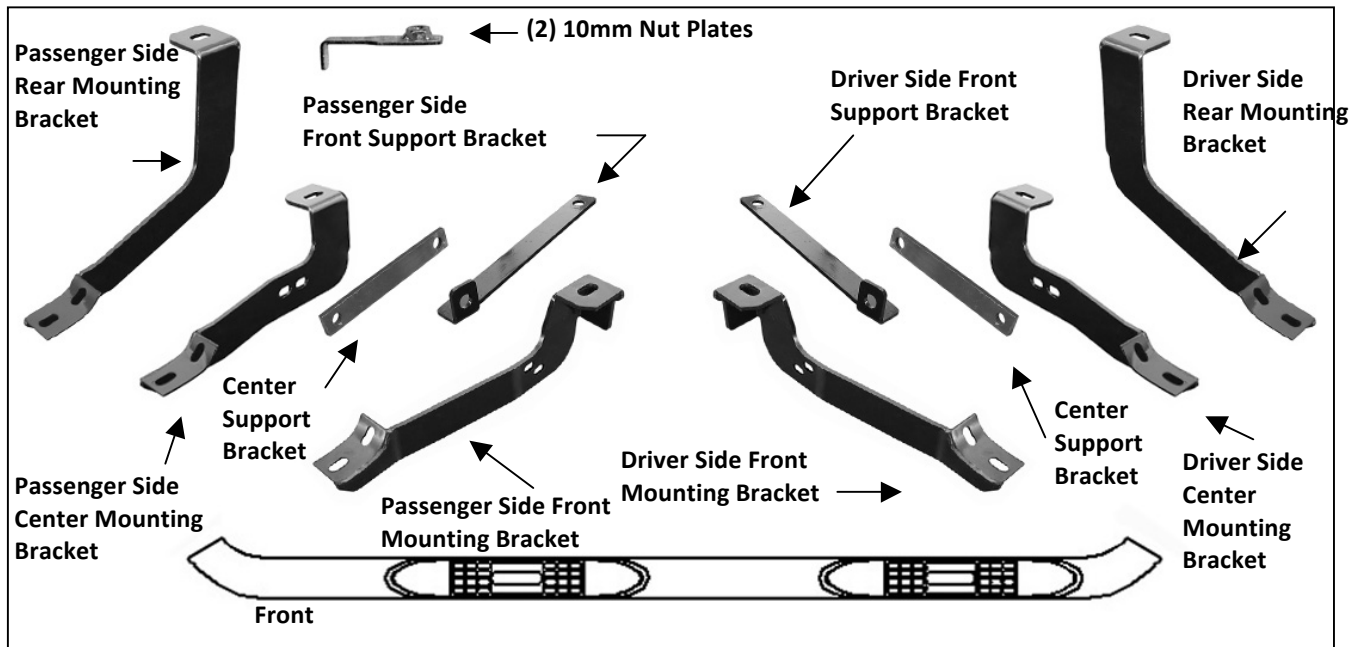

**PROCEDURE:**

**REMOVE CONTENTS FROM BOX. VERIFY ALL PARTS ARE PRESENT. READ FACTORY BODY BOLT REMOVAL INSTRUCTIONS AND INSTALLATION INSTRUCTIONS CAREFULLY BEFORE STARTING INSTALLATION.**

1. Start the installation under the driver side of the vehicle and remove the front, center and rear body mount bolts. Do not remove bushings.
2. Hang the driver side front, center and rear Mounting Brackets from the body mounts in the order pictured above using the factory hex bolts, **(Figures 1 & 2)**. Do not tighten hardware at this time.
3. Locate the two factory holes in the bottom of the frame towards the front of the vehicle. Insert (1) 10mm Nut Plate, **(Figure 3A)**, into the oval hole and line up the threaded nut with the forward round hole, **(Figure 3B)**.  
**NOTE:** Nut Plate and Support Brackets are not required on 2011-12 25-3500 models.
4. Attach the driver side front Support Bracket to the Nut Plate with (1) 10mm x 30mm Hex Bolt, (1) 10mm Lock Washer and (1) 10mm Flat Washer, **(Figures 4 & 5)**. Do not tighten hardware at this time.

**1500 Models:**

Attach the bent end of the Front Support Bracket to the outside hole in the Front Mounting Bracket with (1) 10mm x 30mm Hex Bolt, (2) 10mm Flat Washers, (1) 10mm Lock Washer and (1) 10mm Hex Nut, **(Figure 4)**. Do not tighten at this time.

**Up to 2010 25-3500 Models-Support Bracket not required on 2011-12 25-3500 Models:**

Note that the Front Support Bracket will not reach up to the Mounting Bracket, **(Figure 5)**. Tighten the Support Bracket to the Nut Plate in the frame. Carefully push up on the Support Bracket until it reaches the inside hole in the Mounting Bracket. Bolt the Support Bracket to the hole in the Mounting Bracket with (1) 10mm x 30mm Hex Bolt, (2) 10mm Flat Washers, (1) 10mm Lock Washer and (1) 10mm Hex Nut. Do not tighten at this time.

**All 1500 and up to 2010 25-3500 Models-Support Bracket not required on 2011-12 25-3500 Models:**

5. Move to the Center Mounting Bracket. Select (1) Center Support Bracket-note the two different sizes of mounting holes in the Bracket. Slide the end of the Center Support Bracket with the larger mounting hole between the factory body mount and the Center Mounting Bracket. Attach the Support Bracket to the body mount using the included (1) 12mm x 30mm Hex Bolt, (2) 12mm Flat Washers, (1) 12mm Lock Washer and (1) 12mm Hex Nut, **(Figures 6 & 7)**. Do not tighten at this time. **NOTE:** Larger hole on the Center Support Bracket mounts to body mount.
6. Attach the opposite end of the Support Bracket to the Center Mounting Bracket with (1) 10mm x 30mm Hex Bolt, (2) 10mm Flat Washers, (1) 10mm Lock Washer and (1) 10mm Hex Nut, **(Figures 6 & 7)**. Do not tighten at this time.
7. Carefully position the Driver Sidebar onto the Mounting Brackets. Attach the Sidebar to the Mounting Brackets with (6) 8mm x 25mm Hex Bolts, (6) 8mm Lock Washers and (6) 8mm Flat Washers, **(Figure 8)**. Do not tighten hardware at this time.
8. Level and adjust the Sidebar and tighten all hardware.
9. Repeat steps 2-8 for passenger Sidebar installation.
10. Do periodic inspections to the installation to make sure that all hardware is secure and tight.

**To protect your investment**, wax this product after installing. Regular waxing is recommended to add a protective layer over the finish. Do not use any type of polish or wax that may contain abrasives that could damage the finish.

**For stainless steel:** Aluminum polish may be used to polish small scratches and scuffs on the finish. Mild soap may be used also to clean the Sidebar.

**For gloss black finishes:** Mild soap may be used to clean the Sidebar.

**Driver Side Installation Pictured**

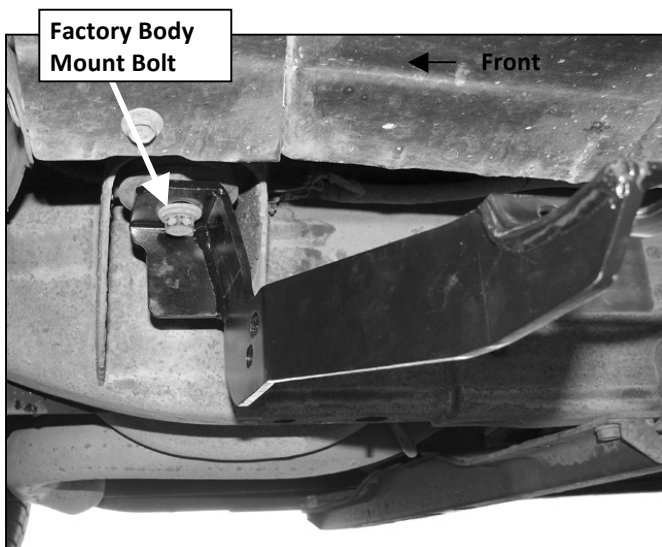

**(Fig 1) Driver side front mounting bracket pictured**

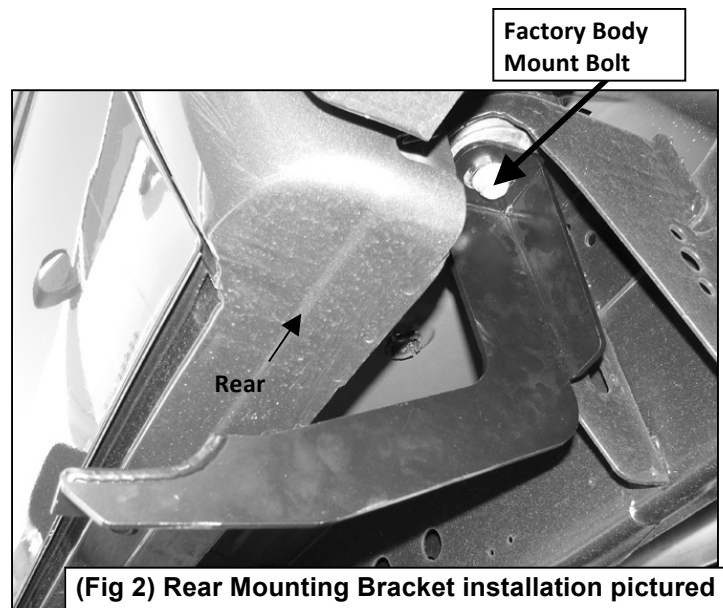

**(Fig 2) Rear Mounting Bracket installation pictured**

### Driver Side Installation Pictured

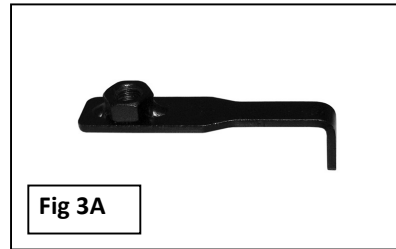
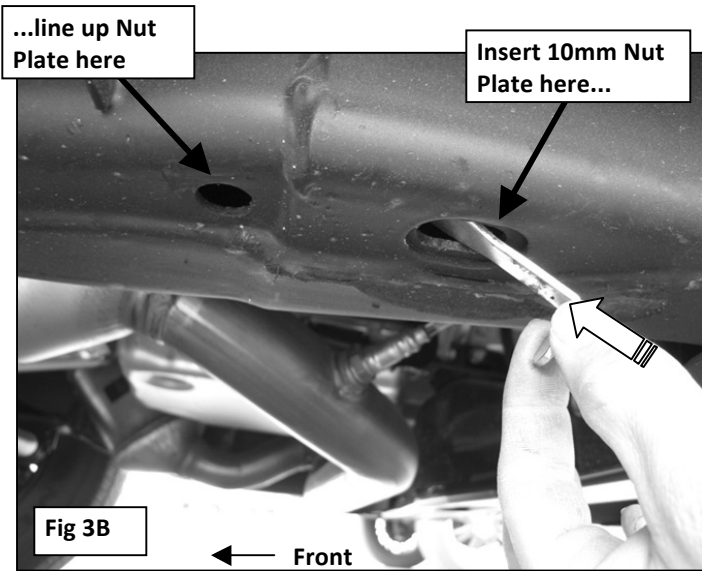

10mm x 30mm Hex Bolt  
(2) 10mm Flat Washers  
10mm Lock Washer  
10mm Hex Nut

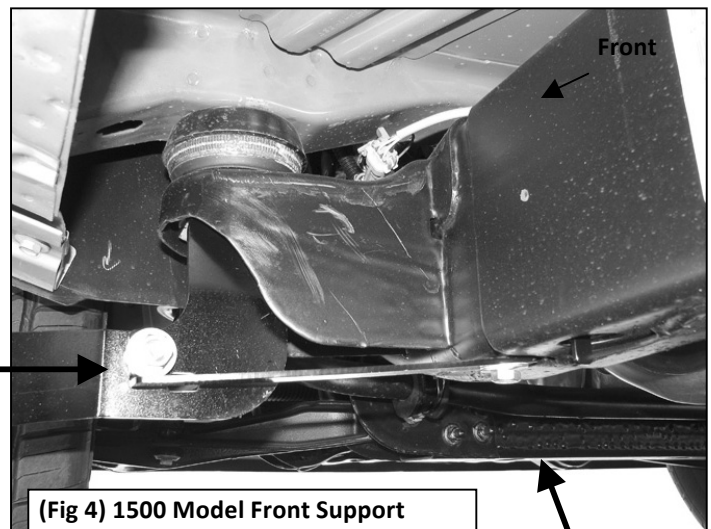

10mm Nut Plate  
10mm x 30mm Hex Bolt  
10mm Lock Washer  
10mm Flat Washer

**NOTE: Support Brackets not required on 2011-12 25-3500 Models**



10mm Nut Plate  
10mm x 30mm Hex Bolt  
10mm Lock Washer  
10mm Flat Washer

**IMPORTANT NOTE:**  
Bend Support Bracket up by hand to meet the inner hole in the Front Mounting Bracket

**NOTE: Support Bracket not required on 2011-12 25-3500 Models**

### Driver Side Installation Pictured



(Fig 6) 1500 Model Center Support Bracket Installation Pictured

**NOTE: Support Brackets not required on 2011-12 25-3500 Models**

10mm x 30mm Hex Bolt  
(2) 10mm Flat Washers  
10mm Lock Washer  
10mm Hex Nut

12mm x 30mm Hex Bolt  
(2) 12mm Flat Washers  
12mm Lock Washer  
12mm Hex Nut



(Fig 7) 25-3500 Model Center Support Bracket Installation Pictured

**NOTE: Support Bracket not required on 2011-12 25-3500 Models**

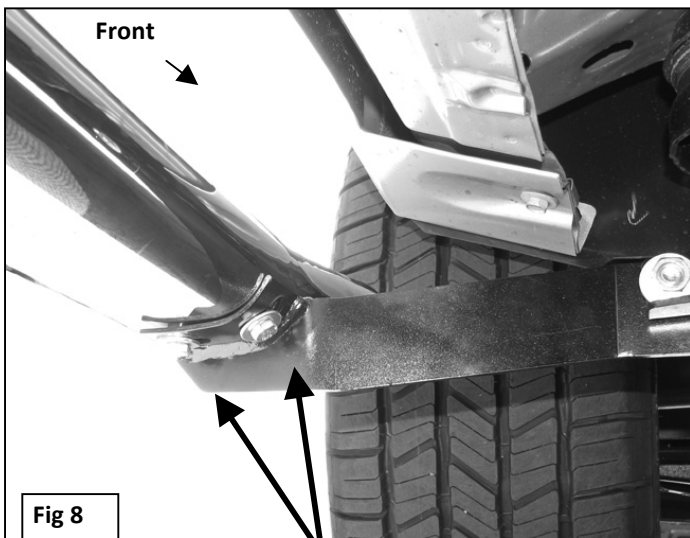

Fig 8

(2) 8mm x 25mm Hex Bolts  
(2) 8mm Lock Washers  
(2) 8mm Flat Washers



Complete Installation