

Installation Instructions



Premium Style. Lasting Performance.

For proper installation and best possible fit, please read all instructions BEFORE you begin.
For technical assistance or to obtain missing parts, please call Customer Relations at 1-800-241-7219.

Para una instalación adecuada y el mejor ajuste posible, lea todas las instrucciones ANTES de comenzar.
Para obtener asistencia técnica o para obtener piezas que faltan, por favor llame a Relaciones con el cliente en 1-800-241-7219.

Pour une installation correcte et le meilleur ajustement possible, s'il vous plaît lire toutes les instructions AVANT de commencer.
Pour une assistance technique ou pour obtenir des pièces manquantes, s'il vous plaît communiquer avec les Relations à la clientèle au 1-800-241-7219.

Care and Cleaning

- **Wash only with mild soap & dry with a clean cloth.**
Lavar con jabón suave y seque con un paño limpio.
Laver avec un savon doux et séchez avec un chiffon propre.
- **Every 3 months or 5000 miles check the cover tension and all components for tightness.**
Revise cada 3 meses o 5,000 millas la tensión de la cubierta y todos los componentes estén ajustados.
Vérifiez tous les 3 mois ou 5000 miles la tension couvercle et le serrage des composants.

Congratulations!

You have purchased one of the many quality Lund® branded products offered by Lund International, Inc. We take the utmost pride in our products and want you to enjoy years of satisfaction from your investment. We have made every effort to ensure that your product is top quality in terms of fit, durability, finish and ease of installation.

Usted ha comprado uno de los muchos productos de calidad ofrecidos por Lund® de marca productos ofrecidos por Lund International, Inc. Tomamos el orgullo extremo en nuestros productos y queremos que disfrute durante años de su inversión. Hemos hecho todos los lo posible para que su producto es de calidad superior en cuanto a ajuste, durabilidad, acabado y facilidad de la instalación.

Vous avez acheté un des nombreux produits de qualité offerts par Lund® marque produits offerts par Lund International, Inc Nous sommes extrêmement fiers de nos produits et souhaitons que vous tiriez des années de satisfaction de votre investissement. Nous avons pris toutes les efforts pour s'assurer que votre produit est de qualité supérieure en termes de durabilité, de finition et la facilité de l'installation.

IMPORTANT ALERT: GM uses a very strong thread-locking compound on all body bolts. Use of an air assisted impact ratchet can cause damage to the threads on factory body mount bolts and the internal nut assembly because of this thread locking compound.

We only recommend the use of hand tools to slowly remove and reinstall body mount bolts on all GM vehicles.

PROCEDURE:

CRITICAL INFORMATION: If during the removal process, it becomes increasingly difficult to unscrew the body mount bolt with hand tools, tighten the bolt several rotations to clear the thread locking compound from the threads, then reverse direction and continue to unscrew until the body mount bolt is out. Repeat this process as necessary on all GM body mount bolts. Use of an appropriate anti-seize compound is highly recommended for re-installation. Tighten body mount bolt to factory torque specifications for your particular model year.

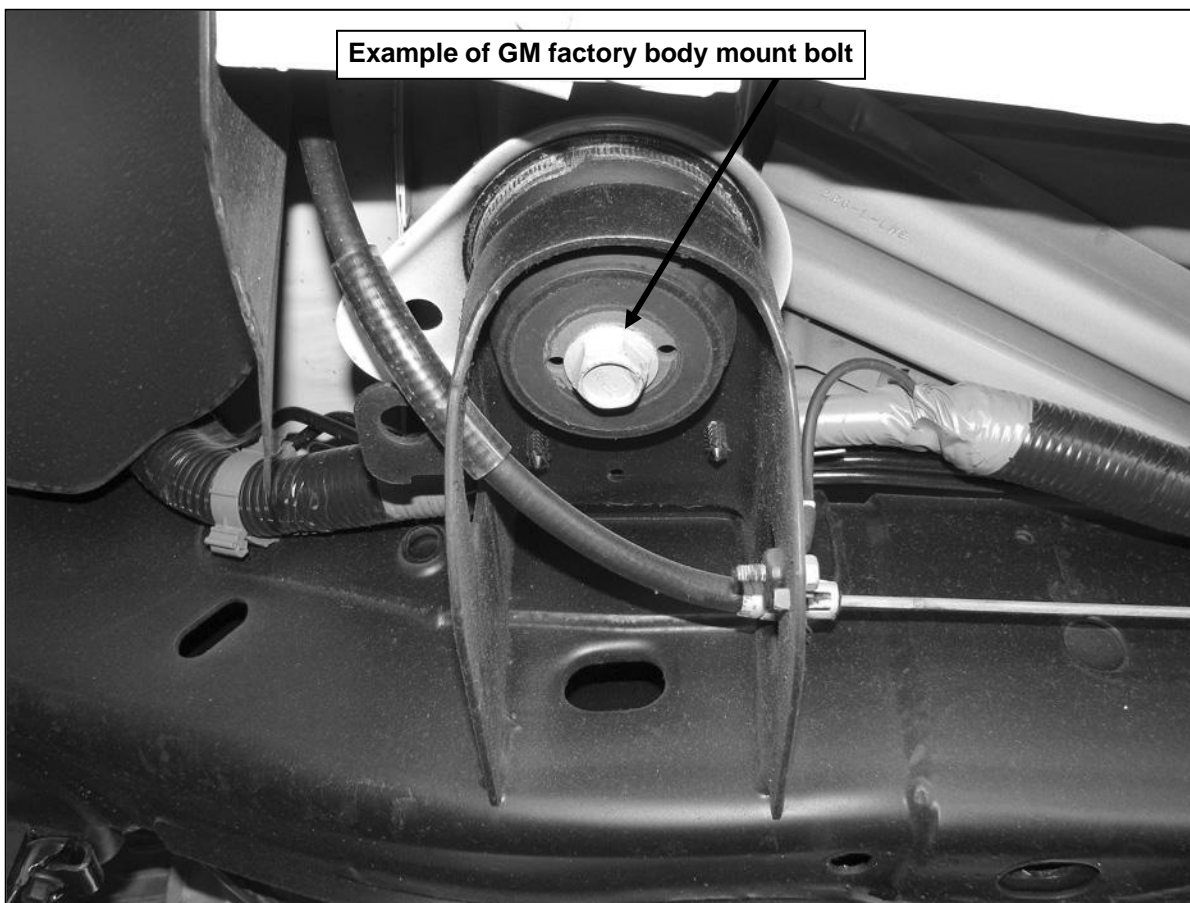

INSTALLATION INSTRUCTIONS

PART# 23278379

PARTS LIST:

Qty	Description	Qty	Description
1	Driver/Left Sidebar	1	Driver/Left Rear Mounting Bracket
1	Passenger/Right Sidebar	1	Passenger/Right Rear Mounting Bracket
1	Driver/Left Front Mounting Bracket	4	1/2" x 2" Hex Bolts
1	Passenger/Right Front Mounting Bracket	4	1/2" Lock Washers
1	Driver/Left Center Support Bracket	4	1/2" x 1-1/2" OD x 1/8" Large Flat Washers
1	Passenger/Right Center Support Bracket	6	8-1.25mm x 25mm Hex Bolts
1	Driver/Left Center Mounting Bracket	6	8mm Lock Washers
1	Passenger/Right Center Mounting Bracket	6	8mm x 24mm x 2mm flat washer

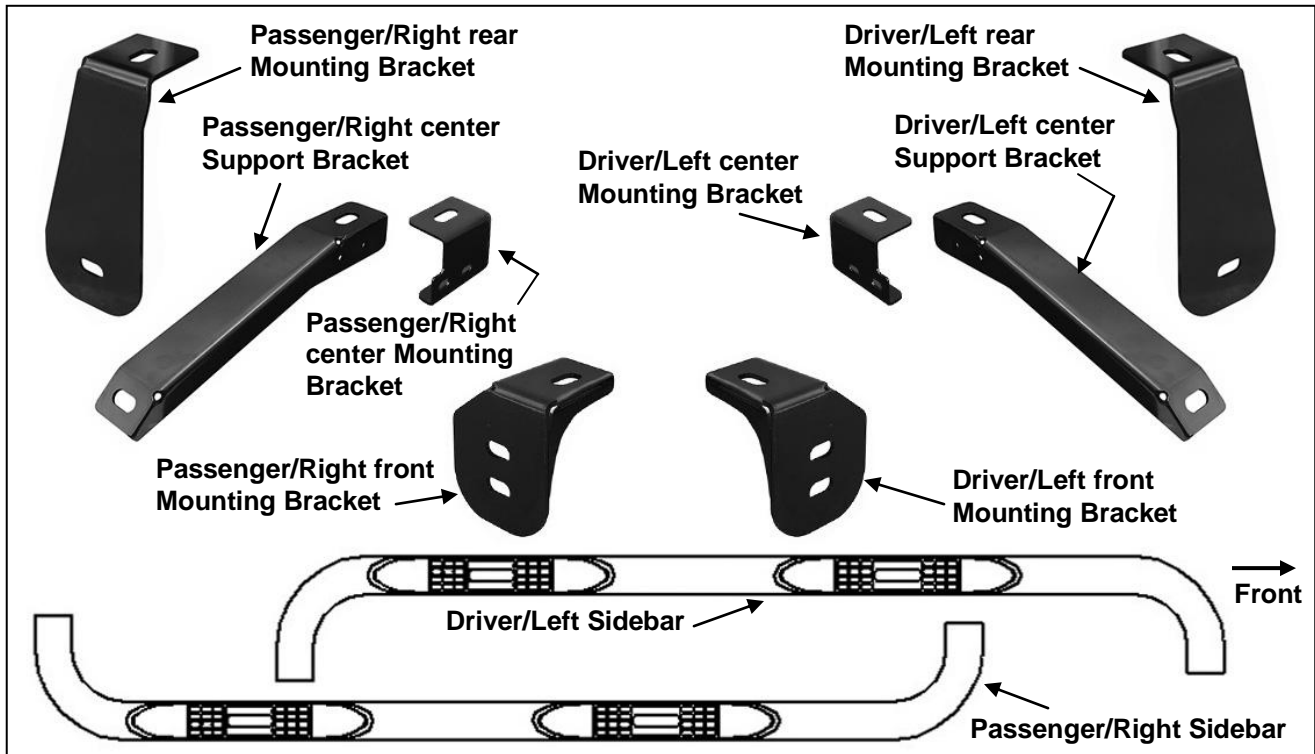

PROCEDURE:

REMOVE CONTENTS FROM BOX. VERIFY ALL PARTS ARE PRESENT. READ THE "FACTORY BODY BOLT REMOVAL INSTRUCTIONS" AND INSTALLATION INSTRUCTIONS CAREFULLY BEFORE STARTING INSTALLATION. ASSISTANCE IS RECOMMENDED.

1. Start installation on the front, driver side of the vehicle. Remove the front body mount bolt, **(Figure 1)**.
2. Select the driver side front Mounting Bracket, **(Figure 2A)**. Insert the factory body mount bolt through the Mounting Bracket, factory washer if equipped and up into the mount. Snug but do not fully tighten the body bolt at this time, **(Figure 2B)**. **VERY IMPORTANT!** To prevent unnecessary noise, adjust the position of all Mounting Brackets so that once tightened, the Mounting Brackets cannot come in contact with the factory steel body mount bracket.
3. Move to the center body mount. Remove the body bolt as previously described. Determine correct procedure for your model and year.

2014-On 1500 Double Cab:

- a. Select the driver/left Support Bracket, **(Figure 3A)**. Repeat **Step 2** to install the Center Support Bracket only, **(Figure 3B)**.

1999-2013 1500, 1999-2015 25-3500:

- a. Select the driver side Center Mounting Bracket, **(Figure 3A)**. Attach the Mounting Bracket to the body mount as previously described in **Step 2, (Figure 3C)**. Make sure the Bracket is straight and tighten the body bolt.
 - b. Select the driver side Center Support Bracket, **(Figure 3A)**. Bolt the Support Bracket to the inside of the Mounting Bracket with (2) 8mm Hex Bolts, (2) 8mm Lock Washers and (2) 8mm Flat Washers, **(Figure 3C)**. Leave 8mm hardware loose.
4. Move toward the rear of the vehicle. Select the driver side Rear Mounting Bracket, **(Figure 4)**. Bolt the rear Mounting Bracket in place as previously described in **Step 2, (Figure 7)**.
 5. With assistance, position the diver/left Sidebar up to the front Mounting Bracket. Determine the correct mounting hole to use:
2014-On 1500 Double Cab: Attach the Sidebar to the top slot in the front Bracket, **(Figures 2A & 5)**.
1999-2013 1500, 1999-2015 25-3500: Attach the Sidebar to the bottom slot in the front Bracket, **(Figures 2A & 5)**.
 6. Attach the front and rear of the Sidebar to the Brackets with the included (2) 1/2" x 2" Hex Bolts, (2) 1/2" Lock Washers and (2) 1/2" Flat Washers, **(Figures 5 & 7)**. Do not tighten hardware at this time.
 7. Attach the center Mounting Bracket to the Sidebar with the included (1) 8mm x 25mm Hex Bolt, (1) 8mm Lock Washer and (1) 8mm Flat Washer, **(Figure 6)**. If the Bracket does not line up with the insert, it may be necessary to loosen the body bolt slightly to move the Bracket. Do not tighten the 8mm hardware at this time.
 8. Level and adjust the Sidebar and tighten all hardware. Check all mounting locations for clearance between the factory steel body mount brackets and the Mounting Brackets. Adjust Brackets if necessary and once satisfied with fit, fully tighten all hardware.
 9. Repeat **Steps 1—8** for passenger Sidebar installation.
 10. Do periodic inspections to the installation to make sure that all hardware is secure and tight.

To protect your investment, wax this product after installing. Regular waxing is recommended to add a protective layer over the finish. Do not use any type of polish or wax that may contain abrasives that could damage the finish.

For stainless steel: Aluminum polish may be used to polish small scratches and scuffs on the finish. Mild soap may be used also to clean the Sidebar.

For gloss black finishes: Mild soap may be used to clean the Sidebar.

Driver side installation pictured

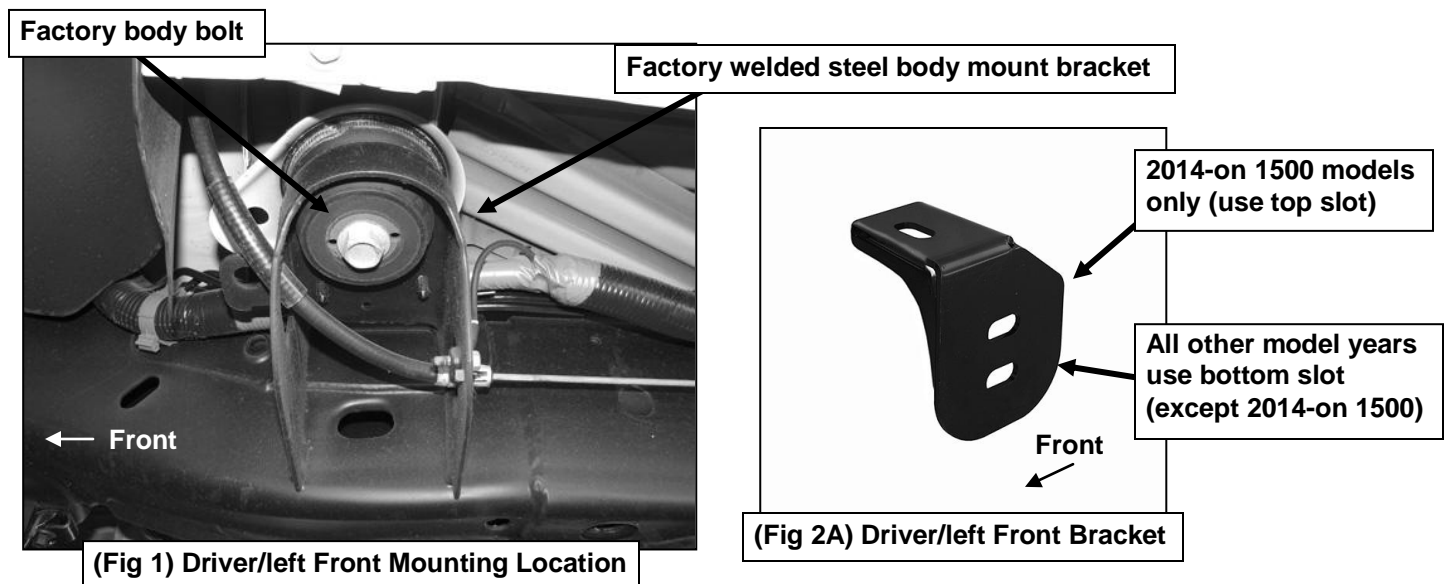

Driver side installation pictured

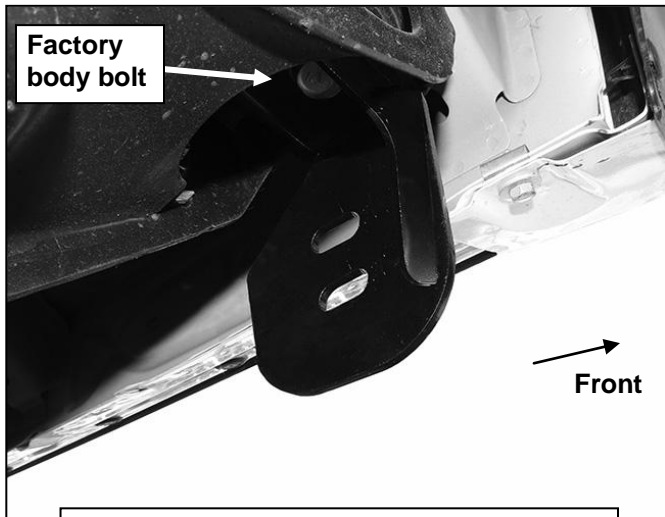

(Fig 2B) Driver/left Front Bracket installed

**2014-on 1500 models only
(Mounting Bracket not required)**

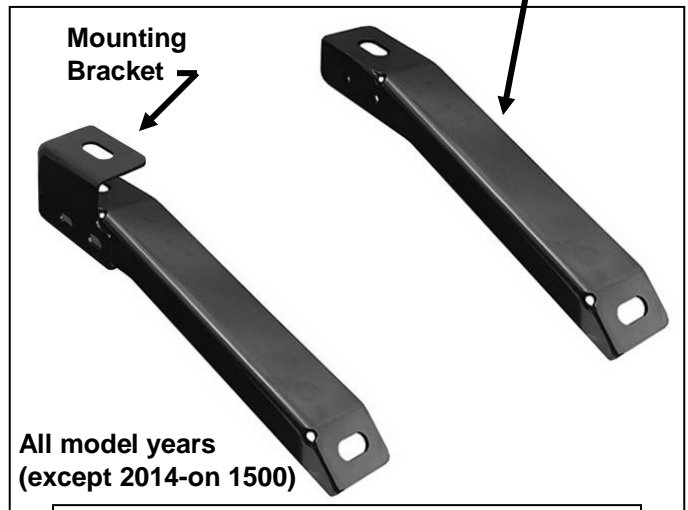

**All model years
(except 2014-on 1500)**

(Fig 3A) Driver/left Center Bracket assembly

Factory body bolt

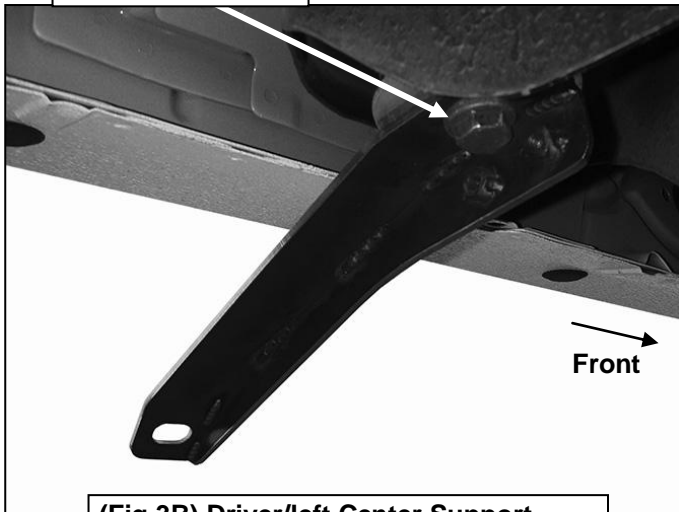

**(Fig 3B) Driver/left Center Support
Bracket only as installed on 2014 1500**

**(2) 8mm Hex Bolts
(2) 8mm Lock Washers
(2) 8mm Flat Washers**

Factory body bolt

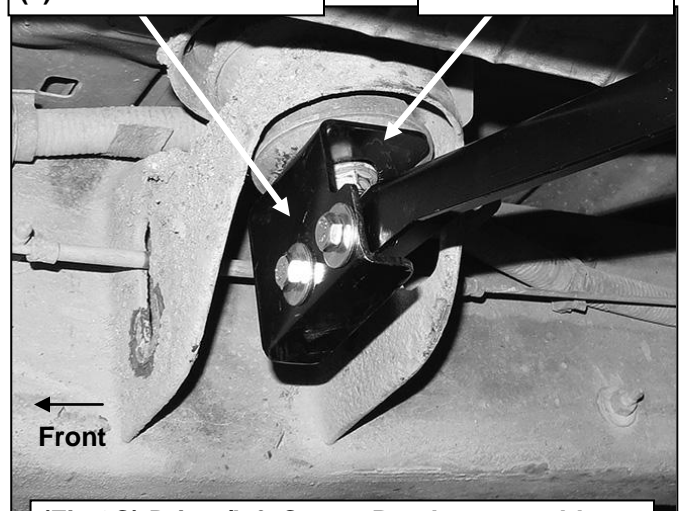

**(Fig 3C) Driver/left Center Bracket assembly as
installed on all model years (except 2014 1500)**

Driver side installation pictured

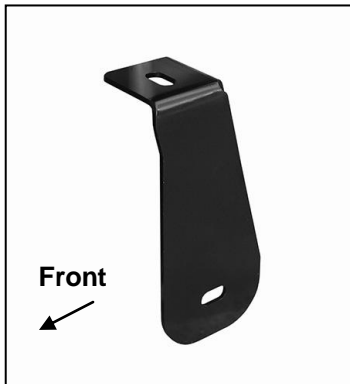

(Fig 4) Driver/left rear Bracket



Factory body bolt

1/2" x 2" Hex Bolt
1/2" Lock Washer
1/2" Flat Washer

(Fig 5) Driver/left front Bracket

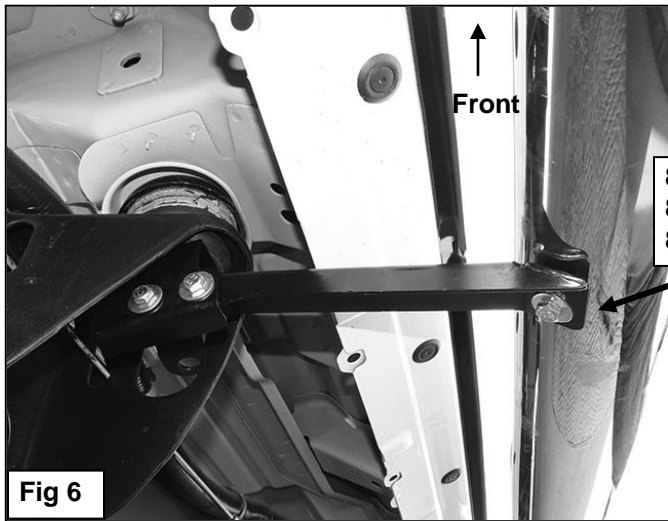

8mm x 25mm Hex Bolt
8mm Lock Washer
8mm Flat Washer

Fig 6

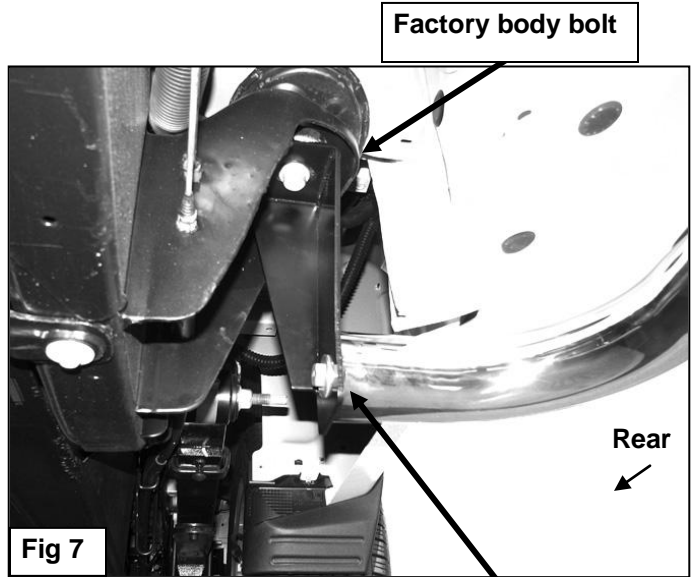

Factory body bolt

1/2" x 2" Hex Bolt
1/2" Lock Washer
1/2" Flat Washer

Fig 7



Complete Installation