

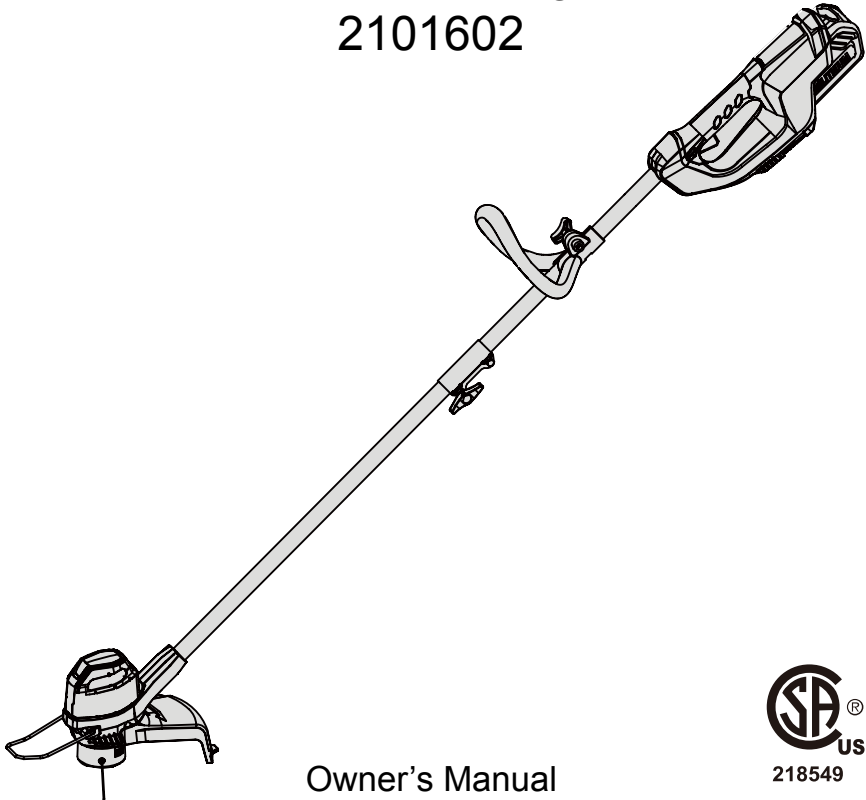

greenworks™

40V Lithium-Ion String Trimmer
2101602



Owner's Manual

TOLL-FREE HELPLINE: 1-888-90WORKS (888.909.6757)

www.GreenWorksTools.com

218549

 Read all safety rules and instructions carefully before operating this tool.

CONTENTS

Contents	2
Product Specifications	2
Important Safety Instructions.....	3
Symbols.....	6
Know Your String Trimmer	8
Assembly	10
Operation.....	16
Battery & Charger Maintenance.....	24
Maintenance.....	26
Environmentally Safe Battery Disposal	27
Troubleshooting.....	28
Warranty.....	30
Exploded View and Part List.....	31

PRODUCT SPECIFICATIONS

40V LITHIUM-ION STRING TRIMMER

Type.....	Cordless, battery powered
Motor	40V Brushed
Cutting Width	12 in. (30 cm)
Line Diameter	Nylon / 0.065" (1.65 mm)
Speed	7500 (±10%) RPM
Run Time	Up to 30 minutes
Charge Time	60 minutes
Feed Type	Auto Feed
Weight (with 2Ah battery)	7.87 lbs (3.57 kg)



IMPORTANT SAFETY INSTRUCTIONS

WARNING

Read and understand all instructions before using this product. Failure to follow all instructions listed below may result in electric shock, fire, and/or serious personal injury.

- Use only identical manufacturer's replacement parts and accessories. Use of any other parts may create a hazard or cause product damage.
- Always wear safety glasses with side shields marked to comply with ANSI Z87.1. Everyday glasses have only impact resistant lenses. They are NOT safety glasses. Following this rule will reduce the risk of eye injury. Use face mask if operation is dusty.
- Avoid Dangerous Environment — Don't expose power tools to damp or wet conditions. Water entering a power tool will increase the risk of electric shock.
- Don't use in rain.
- Keep all bystanders, children, and pets at least 50 ft. away.
- Use Right Appliance – Do not use appliance for any job except that for which it is intended.
- Avoid Unintentional Starting – Do not carry string trimmer with fingers on the switch. Be sure the battery is removed while transporting.
- Do not operate the equipment while barefoot or when wearing sandals or similar lightweight footwear. Wear protective footwear that will protect your feet and improve your footing on slippery surfaces.
- Don't overreach - Keep proper footing and balance at all times.
- Stay alert - Watch what you are doing. Use common sense. Do not operate this unit when you are tired, ill or under the influence of alcohol, drugs or medication.
- Store idle appliances indoors - When not in use, appliances should be stored indoors in dry, and high or locked-up place - out of reach of children.
- Maintain appliance with care – Replace string head if cracked, chipped, or damaged in any way. Be sure the string head is properly installed and securely fastened. Keep cutting edge sharp and clean for best performance and to reduce the risk of injury. Follow instructions for lubricating and changing accessories. Inspect appliance cord periodically, and if damaged, have it repaired by an authorized service facility. Inspect extension cords periodically and replace if damaged. Keep handles dry, clean, and free from oil and grease. Failure to do so can cause serious injury.
- Check Damaged Parts – Before further use of the appliance, a guard or other part that is damaged should be carefully checked to determine that it will operate properly and perform its intended function. Check for alignment of moving parts, binding of moving parts, breakage of parts, mounting, and any other condition that may affect its operation. A guard or other part that is damaged should be properly repaired or replaced by an authorized service center unless indicated elsewhere in this manual.
- Do not charge or operate cordless tools in damp or wet locations or in the rain. Following this rule will reduce the risk of electric shock.
- Remove or disconnect battery before servicing, cleaning or removing material from the gardening appliance.

IMPORTANT SAFETY INSTRUCTIONS

- Do not dispose of the batteries in a fire. The cells may explode. Check with local codes for possible special disposal instructions.
- Do not open or mutilate the batteries. Released electrolyte is corrosive and may cause damage to the eyes or skin. It may be toxic if swallowed.
- Exercise care in handling batteries in order not to short the battery with conducting materials such as rings, bracelets, and keys. The battery or conductor may overheat and cause burns.
- Dress Properly – Do not wear loose clothing or jewelry. They can be caught in moving parts. Use of rubber gloves and substantial footwear is recommended when working outdoors. Wear protective hair covering to contain long hair.
- Don't Force Appliance – It will do the job better and with less likelihood of a risk of injury at the rate for which it was designed.
- Recharge only with the charger specified by the manufacturer. A charger that is suitable for one type of battery pack may create a risk of fire when used with another battery pack.
- For use only with 29462/2901319/29472 battery. For use only with 29482 charger.
- When battery pack is not in use, keep it away from other metal objects, like paper clips, coins, keys, nails, screws or other small metal objects, that can make a connection from one terminal to another. Shorting the battery terminals together may cause burns or a fire.
- Under abusive conditions, liquid may be ejected from the battery; avoid contact. If contact accidentally occurs, flush with water. If liquid contacts eyes, additionally seek medical help. Liquid ejected from the battery may cause irritation or burns.
- Do not use a battery pack or appliance that is damaged or modified. Damaged or modified batteries may exhibit unpredictable behavior resulting in fire, explosion or risk of injury.
- Do not expose a battery pack or appliance to fire or excessive temperature. Exposure to fire or temperature above 130°C may cause explosion. The temperature of 130°C can be replaced by the temperature of 265°F.

IMPORTANT SAFETY INSTRUCTIONS

CHILD SAFETY

Tragic accidents can occur if the operator is not aware of the presence of children.

- Keep children out of the working area and under the watchful care of a responsible adult.
- Do not allow children under the age of 14 to operate this trimmer. Children who are 14 years of age and older must read and understand the operating instructions and safety rules in this manual and must be trained and supervised by a parent.
- Stay alert, and turn the trimmer off if a child or any other person enters the working area.
- Look behind and down for small children before and while cutting backwards.
- Use extreme care when approaching blind corners, doorways, shrubs, trees, or other objects that may obscure your view of a child who may run into the path of the trimmer.

⚠ W A R N I N G (PROPOSITION 65)

Some dust created by power sanding, sawing, grinding, drilling, and other construction activities contains chemicals known to cause cancer, birth defects or other reproductive harm. Some examples of these chemicals are:







- Lead from lead-based paints
- Crystalline silica from bricks and cement and other masonry products, and
- Arsenic and chromium from chemically treated lumber.

Your risk of exposure to these chemicals varies depending on how often you do this type of work. To reduce your exposure to these chemicals, work in a well-ventilated area, and work with approved safety equipment, such as dust masks that are specially designed to filter out microscopic particles.

SAVE THESE INSTRUCTIONS



SYMBOLS

Some of the following symbols may be used on this product. Please study them and learn their meaning. Proper interpretation of these symbols will allow you to operate the product better and safer.

SYMBOL	NAME	DESIGNATION/EXPLANATION
V	Volts	Voltage
A	Amperes	Current
Hz	Hertz	Frequency (cycles per second)
W	Watts	Power
min	Minutes	Time
~	Alternating Current	Type of current
—	Direct Current	Type or a characteristic of current
	No Blade	Do not install or use any type of blade on a product or displaying this symbol.
/min	Per Minute	Revolutions, strokes, surface speed, orbits etc., per minute.
	Wet Conditions Alert	Do not expose to rain or use in damp locations.
	Read The Operator's Manual	To reduce the risk of injury user must read and understand operator's manual before using this product.
	Eye Protection	Always wear eye protection with side shields marked to comply with ANSI Z87.1 when operating this equipment.
	Safety Alert	Precautions that involve your safety.
	Ricochet	Thrown objects can ricochet and result in personal injury or property damage.
	Keep Bystanders Away	Keep all bystanders at least 50 ft. away.

SYMBOLS

The following signal words and meanings are intended to explain the levels of risk associated with this product.

SYMBOL	SIGNAL	MEANING
	DANGER	Indicates an imminently hazardous situation, which, if not avoided, will result in death or serious injury.
	WARNING	Indicates a potentially hazardous situation, which, if not avoided, could result in death or serious injury.
	CAUTION	Indicates a potentially hazardous situation, which, if not avoided, may result in minor or moderate injury.
	CAUTION	(Without Safety Alert Symbol) Indicates a situation that may result in property damage.

SERVICE

Servicing requires extreme care and knowledge and should be performed only by a qualified service technician. For service we suggest you return the product to your nearest **AUTHORIZED SERVICE CENTER** for repair. Use only identical manufacturer's replacement parts and accessories.

WARNING

To avoid serious personal injury, do not attempt to use this product until you have read this Owner's Manual thoroughly and understand it completely. If you do not understand the warnings and instructions in this Owner's Manual, do not use this product. Call the Toll-free Helpline (1-888-909-6757) for assistance. The operation of any power tool can result in foreign objects being thrown into your eyes, which can result in severe eye damage. Before operating a power tool, always wear safety goggles, safety glasses with side shields, or a full face shield when needed. We recommend a Wide Vision Safety Mask for use over eyeglasses or standard safety glasses with side shields. Always use eye protection that is marked to comply with ANSI Z87.1.

WARNING



The operation of any power tool can result in foreign objects being thrown into your eyes, which can result in severe eye damage. Before beginning power tool operation, always wear safety goggles or safety glasses with side shields and, when needed, a full face shield. We recommend Wide Vision Safety Mask for use over eyeglasses or standard safety glasses with side shields. Always use eye protection which is marked to comply with ANSI Z87.1.

SAVE THESE INSTRUCTIONS

KNOW YOUR STRING TRIMMER

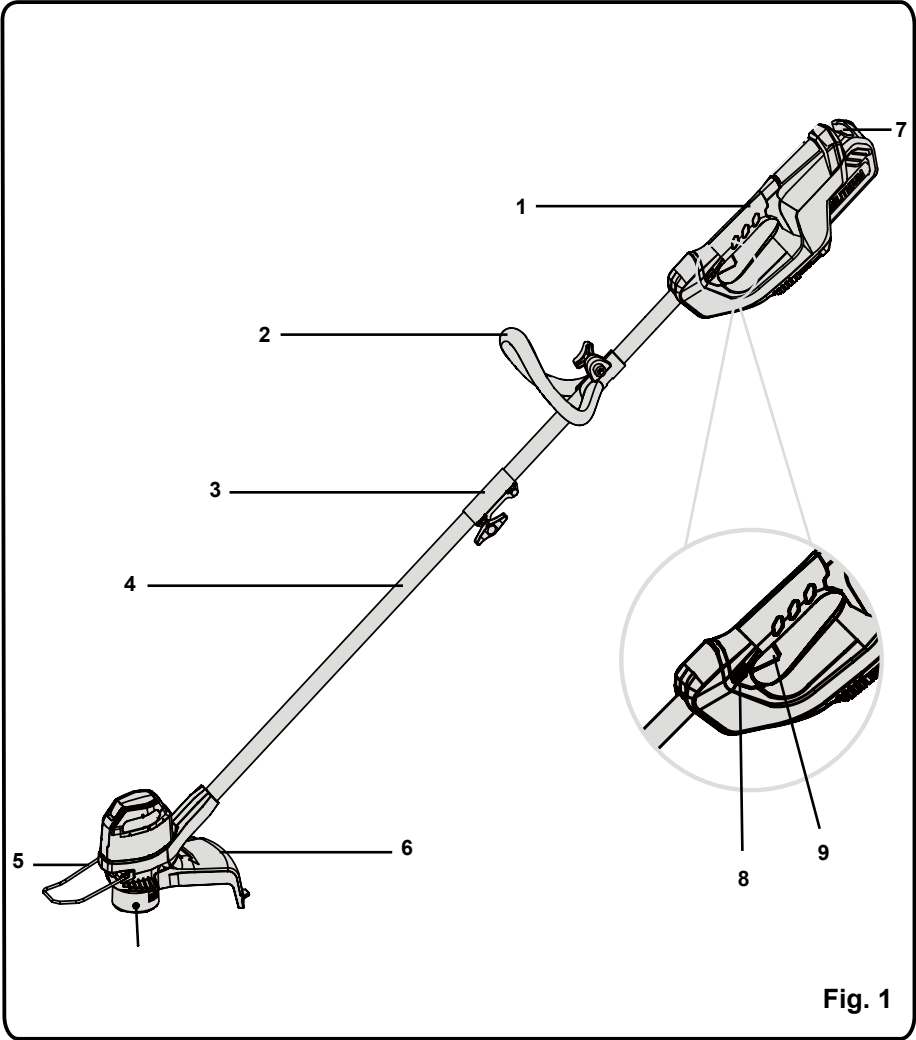

KNOW YOUR STRING TRIMMER

KNOW YOUR STRING TRIMMER (See *Figure 1.*)

The safe use of this product requires an understanding of the information on the product and in this operator's manual as well as a knowledge of the project you are attempting. Before use of this product, familiarize yourself with all operating features and safety rules.

1. REAR HANDLE

Ergonomic handle with overmold improves comfort and grip.

2. AUXILIARY HANDLE

The string trimmer is equipped with an auxiliary handle for ease of operation and to prevent loss of control.

3. COUPLER

The coupler connects and locks the two shafts.

4. TRIMMER SHAFT

The trimmer shaft encloses and protects the cables between the motor and rear handle.

5. EDGE GUIDE

Allows for trimming around flower bed without damaging plants.

6. GUARD

The trimmer includes a guard that helps protect from flying debris.

7. BATTERY PACK LATCH

Press to release the battery pack from the tool.

8. LOCK-OUT BUTTON

The lock-out button prevents accidental starting.

9. SWITCH TRIGGER

To turn the string trimmer On and Off.

ASSEMBLY

UNPACKING







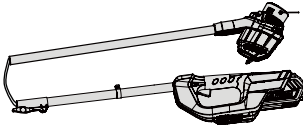

This product requires assembly.

- Carefully remove the product and any accessories from the box. Make sure that all items listed in the packing list are included.
- Inspect the tool carefully to make sure no breakage or damage occurred during shipping.
- Do not discard the packing material until you have carefully inspected and satisfactorily operated the tool.
- If any parts are damaged or missing, please call 1-888-909-6757.

⚠ WARNING

Do not use this product if any parts on the packing list are already assembled to your product when you unpack it. Parts on this list are not assembled to the product by the manufacturer and require customer installation. Use of a product that may have been improperly assembled could result in serious personal injury.

PACKING LIST

Part Name	Figure	Qty
String trimmer		1
Auxiliary handle		1
Guard		1
Edge guide		1
Bonus spool		1
Bonus spool cover		1
Operator's manual		1
Quick start guide		1

ASSEMBLY

⚠ WARNING

If any parts are damaged or missing, do not operate this product until the parts are replaced. Use of this product with damaged or missing parts could result in serious personal injury.

⚠ WARNING

Do not attempt to modify this product or create accessories not recommended for use with this string trimmer. Any such alteration or modification is misuse and could result in a hazardous condition leading to possible serious personal injury.

⚠ WARNING

Do not connect to power supply until assembly is complete. Failure to comply could result in accidental starting and possible serious personal injury.

ASSEMBLY

ATTACHING THE GUARD (See Figure 2.)

NOTE: Install the guard before the attachment is connected to the lower shaft.

1. Invert the string trimmer to access the trimmer head.
2. Remove supplied screws (1) from the trimmer head with a philips screwdriver.

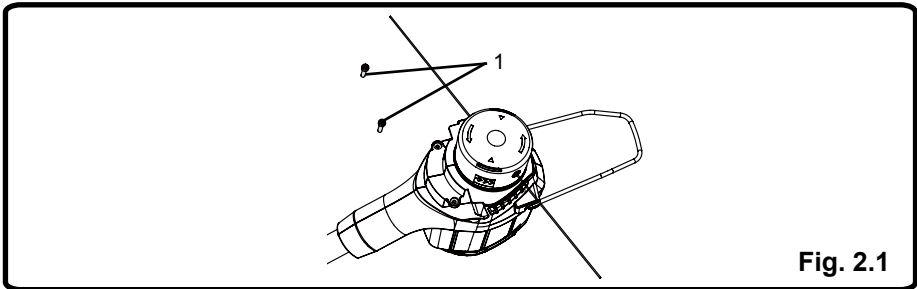

Fig. 2.1

3. Place the guard (2) on to the trimmer head.
4. Align the screw holes on the guard (3) with the screw holes on the trimmer head (4)

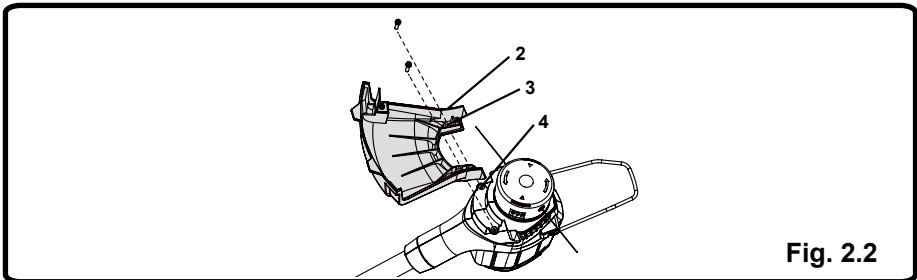

Fig. 2.2

5. Insert the screws into the trimmer head, fastening the guard in place using a philips head screwdriver (not included).

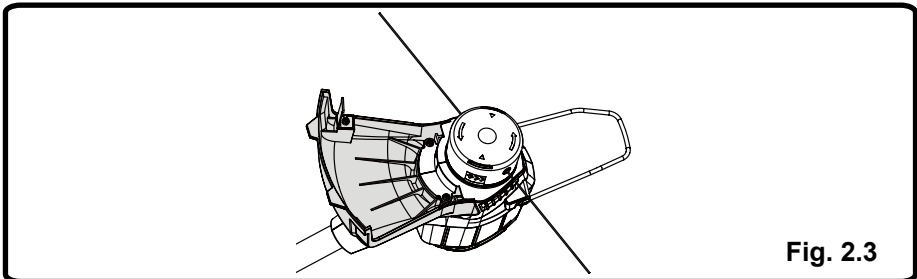

Fig. 2.3

ASSEMBLY

INSTALLING THE UPPER SHAFT TO THE LOWER SHAFT (See Figure 3.)

⚠ WARNING

Never install, remove, or adjust any attachment while string trimmer is running. Failure to stop the motor can cause serious personal injury.

The attachment connects to the power head by means of a coupler device.

1. Set the unit on a flat, level surface.
2. Loosen the knob (1) on the coupler (5).
3. Push in the release button (2) located on the lower shaft (3). Align the release button with the positioning hole (4) and slide the two shafts together. Rotate the lower shaft until the button locks into the positioning hole.

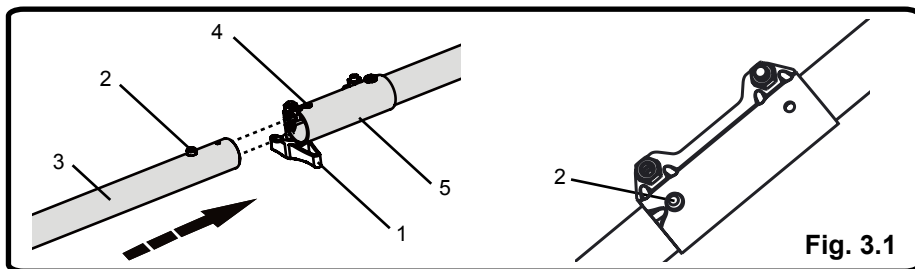

NOTE: If the button does not release completely in the positioning hole, the shafts are not locked into place. Slightly rotate from side to side until the button is locked into place.

4. Tighten the knob securely.

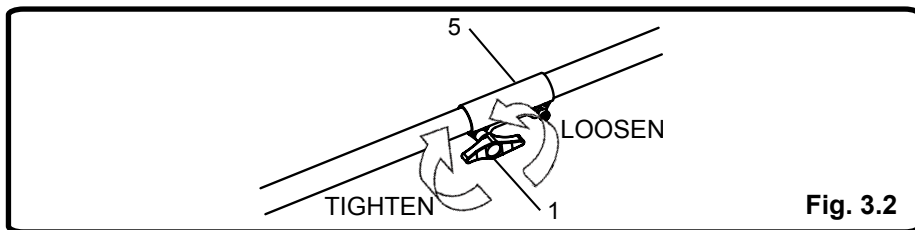

ASSEMBLY

ATTACHING THE AUXILIARY HANDLE (See Figure 4.)

1. Press the auxiliary handle (1) onto the upper shaft so that the handle is angled toward the rear handle that allows for comfortable operation.
2. Slide the auxiliary handle over the metal ring (2) and ensure the metal ring fits between the slot on the auxiliary handle.

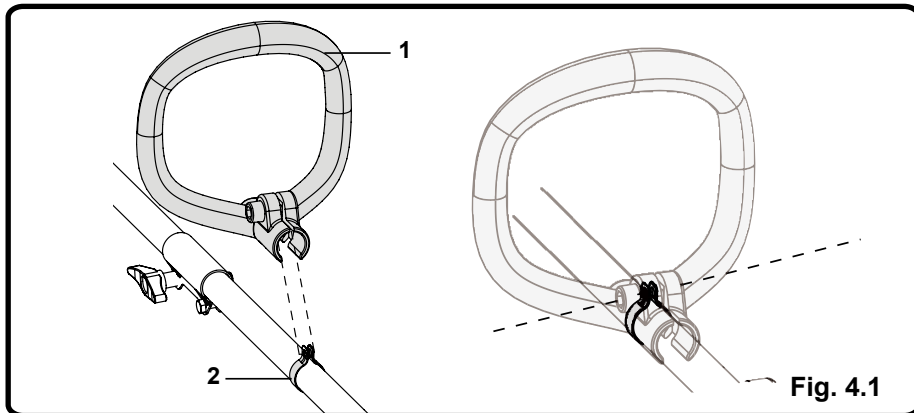

3. Align the holes on the auxiliary handle with the holes on metal ring.
4. Insert the handle knob (3) through the auxiliary handle.

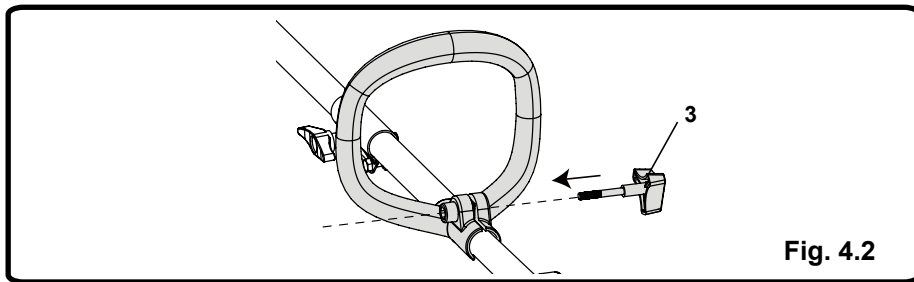

5. Tighten until there is no movement in the handle.

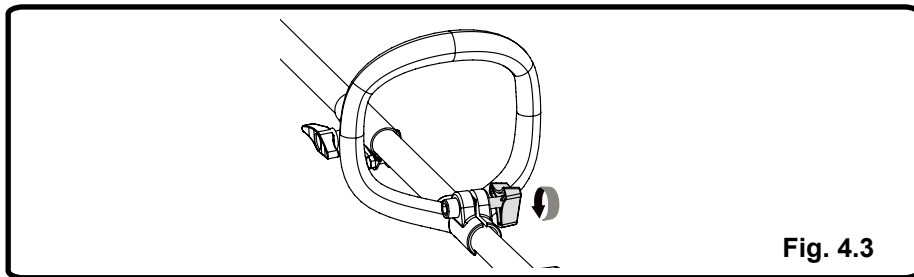

ASSEMBLY

LINE TRIMMING CUT-OFF BLADE (See Figure 5.)

The trimmer is equipped with a line trimming cut-off blade on the guard. Replace the string when trimming efficiency diminishes. This will maintain best performance.

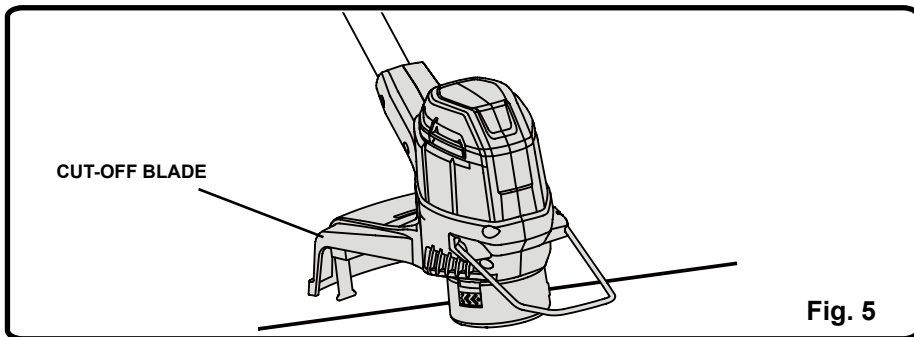

OPERATION

⚠ WARNING

Read and understand entire Operator's Manual for each optional attachment used on this power head and follow all warnings and instructions. Failure to follow all instructions may result in electric shock, fire and/or serious personal injury.

⚠ WARNING

Do not allow familiarity with this product to make you careless. Remember that a careless fraction of a second is sufficient to inflict serious injury.

⚠ WARNING

Do not use any attachments or accessories not recommended by the manufacturer of this product. The use of attachments or accessories not recommended can result in serious personal injury.

⚠ WARNING

This string trimmer is not meant to be used with brush cutter attachments. Use of a brush cutter attachment could cause serious personal injuries or property damage.

OPERATION

INSTALLING THE BATTERY PACK (See Figure 6.)

- Place the battery pack in the trimmer. Align raised ribs (3) on battery pack with grooves in the trimmer's battery port.
- Make sure the latch on the back of the battery pack clicks into place and that battery pack is fully seated and secure in the trimmer before beginning operation.

REMOVING THE BATTERY PACK (See Figure 6.)

- Release the switch trigger and lock-out trigger to stop the trimmer.
- Press and hold the battery latch button (1) on the back of the battery pack.
- While holding the battery latch place one hand on the trimmer handle (2) and remove battery pack.

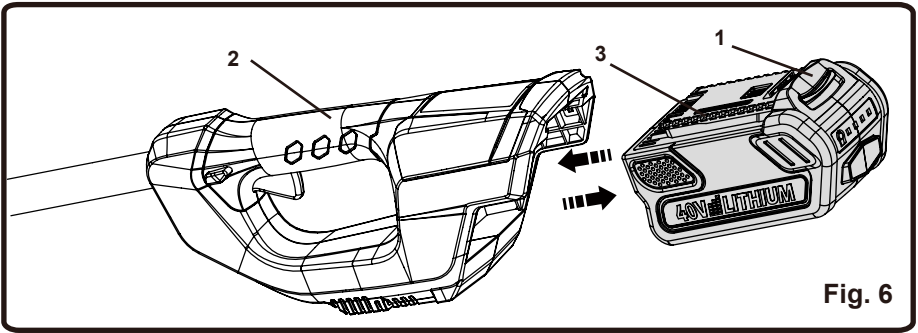

STARTING AND STOPPING THE TRIMMER (See Figure 7.)

- Ensure a fully charged battery is installed into the string trimmer.
- To start the string trimmer, press and hold the lock-out button (1) and squeeze the switch trigger (2).
- To stop the string trimmer, release switch trigger to stop.

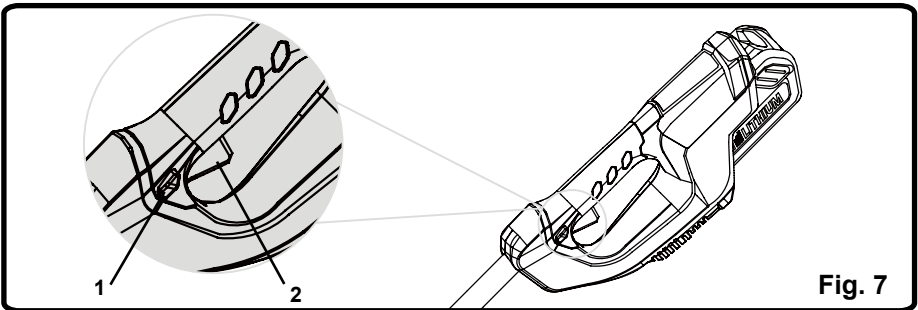

OPERATION

OPERATING THE TRIMMER (See *Figure 8*.)

⚠ WARNING

Always hold the string trimmer away from the body keeping clearance between the body and the string trimmer. Any contact with the string trimmer cutting head while operating can result in serious personal injury.

Follow these tips when using the string trimmer:

- Hold the trimmer with your right hand on the rear handle and your left hand on the auxiliary handle.
- Keep a firm grip with both hands while in operation.
- Trimmer should be held at a comfortable position with the rear handle about hip height.
- Cut tall grass from the top down. This will prevent grass from wrapping around the shaft housing and string head which may cause damage from overheating.

If grass becomes wrapped around the string head:

- Remove the battery pack.
- Remove the grass.

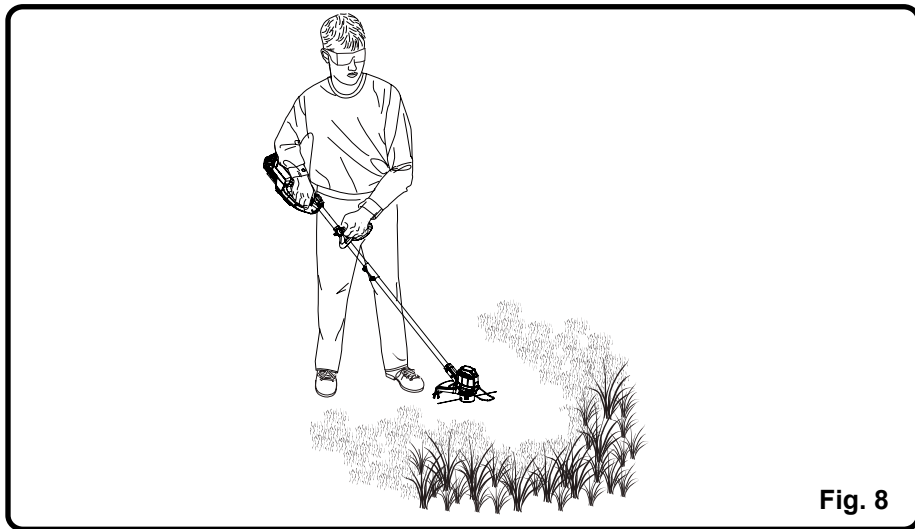

OPERATION

⚠ WARNING

Any contact with the attachment cutting head can result in burns and/or other serious personal injury.

⚠ WARNING

Read the safety information for safe operation when using a blade attachment and refer to the safety rules and instructions in your attachment manual. Never use a brush cutter attachment with this electric power head. Improper operation of a blade or any attachment could result in serious injury.

ADVANCING LINE

The trimmer is equipped with an auto-feed head. Bumping the head to try to advance the line will damage the trimmer and void the warranty.

- With the trimmer running, release the switch trigger.
- Wait two seconds, and press the switch trigger.

NOTE: *The line will extend approximately 1/4 in. with each stop and start of the switch trigger until the line reaches the length of the grass deflector cut-off blade.*

- Resume trimming

ADVANCING THE LINE MANUALLY (See Figure 9.)

- Remove the battery pack.
- Push the black button located on the string head while pulling on line to manually advance the line.

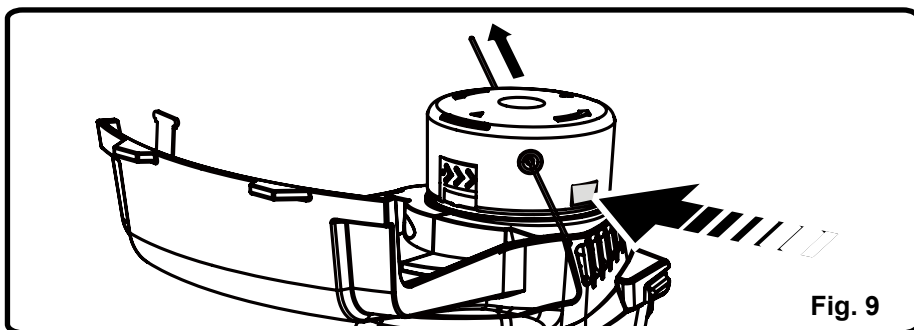
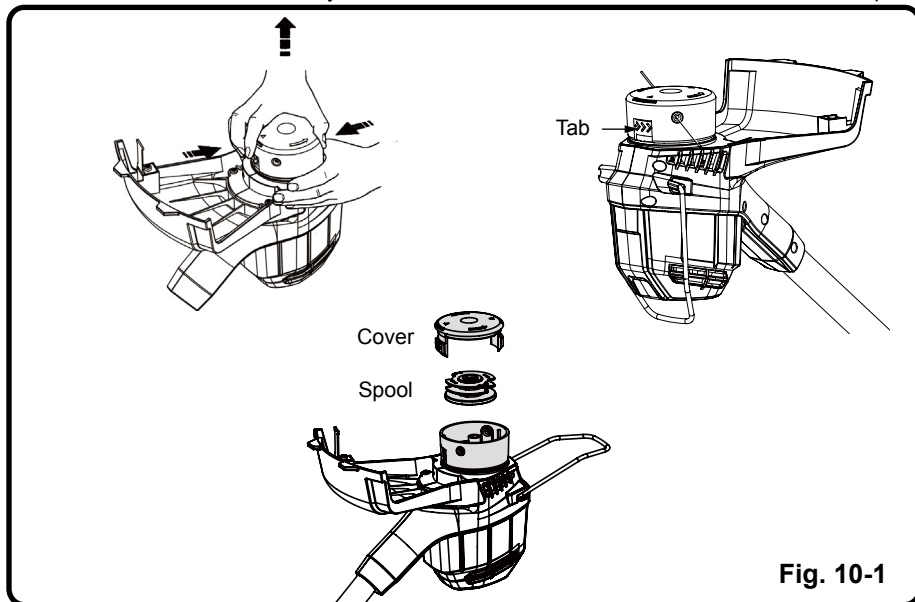

Fig. 9

OPERATION

REPLACING THE LINE (See Figure 10.)

1. Press the tabs simultaneously on the side of the trimmer head and remove cover and spool.



2. Remove any remaining line.
3. Clean dirt and debris from all parts. Replace spool if it is worn or damaged.
4. Replace with a pre-wound spool (#2900719), or replace line using two lines.

⚠ WARNING

Never use wire, rope, string, etc., which can break off and become a dangerous projectile.

5. Cut two lines, each being approximately 10 ft. (3 m) long. Use only .065 in. (1.65 mm) diameter line.

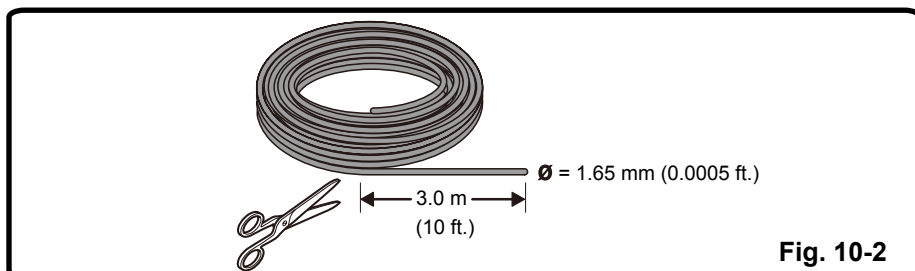

OPERATION

6. Bend one end of the line 1/4 of an inch (0.002 ft.).



Fig. 10-3

7. Insert one line into the anchor hole in the upper part of the spool while the other line into the anchor hole in the bottom part of the spool.

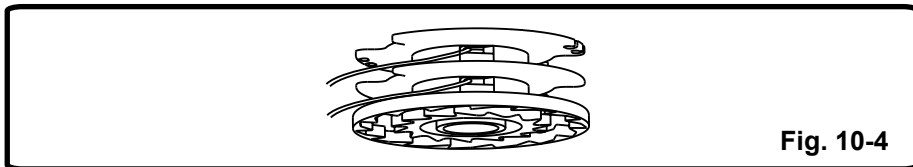

Fig. 10-4

8. Wind the lines clockwise around the spool simultaneously, as shown by the arrows on the spool.

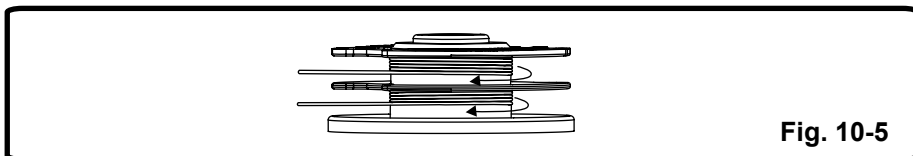

Fig. 10-5

9. Place lines in the slot on the upper spool flange, leaving about 6 in. (152mm) extended beyond the slot.

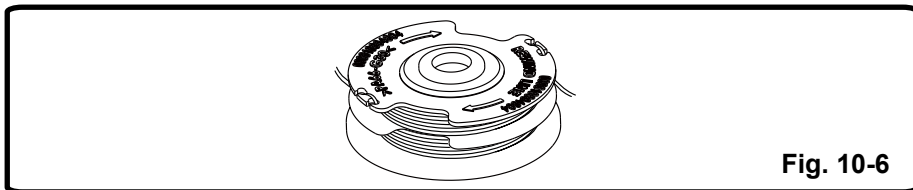

Fig. 10-6

NOTE: Do not overfill. After winding the line, there should be at least 1/4 in. (6mm) between the wound line and the outside edge of the spool.

10. Place the spool in the trimmer head as shown below.

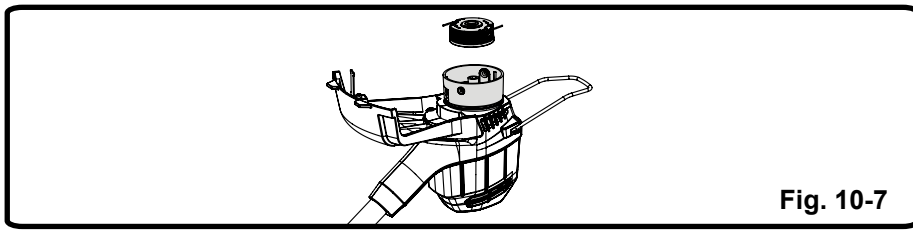
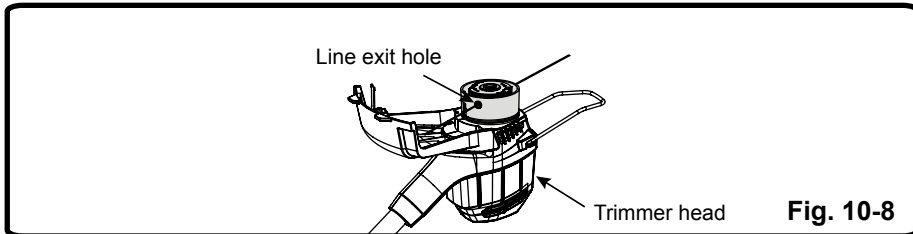

Fig. 10-7

OPERATION

11. Insert the ends of the lines through line exit holes in the sides of the cover.



12. Reinstall the cover onto the trimmer head. Push until cover snaps into place.

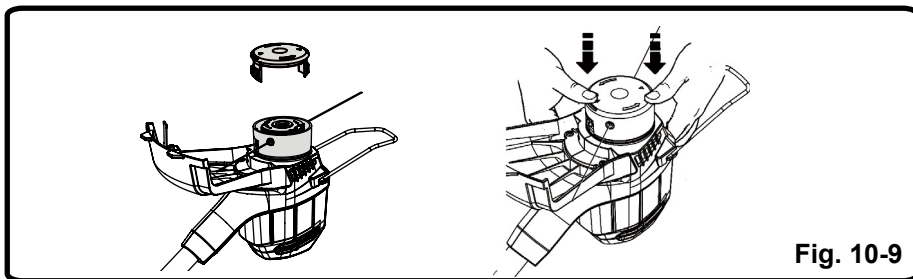

OPERATION

CUTTING TIPS (See *Figure 11*.)

- Keep the trimmer tilted toward the area being cut; this is the best cutting area.
- The trimmer cuts when passing the unit from right to left. This will avoid throwing debris at the operator. Avoid cutting in the dangerous area shown in figure 11.
- Use the tip of string to do the cutting; do not force string head into uncut grass.
- Wire and picket fences cause extra string wear and breakage. Stone and brick walls, curbs, and wood may wear string rapidly.
- Avoid trees and shrubs. Tree bark, wood moldings, siding, and fence posts can easily be damaged by the string.

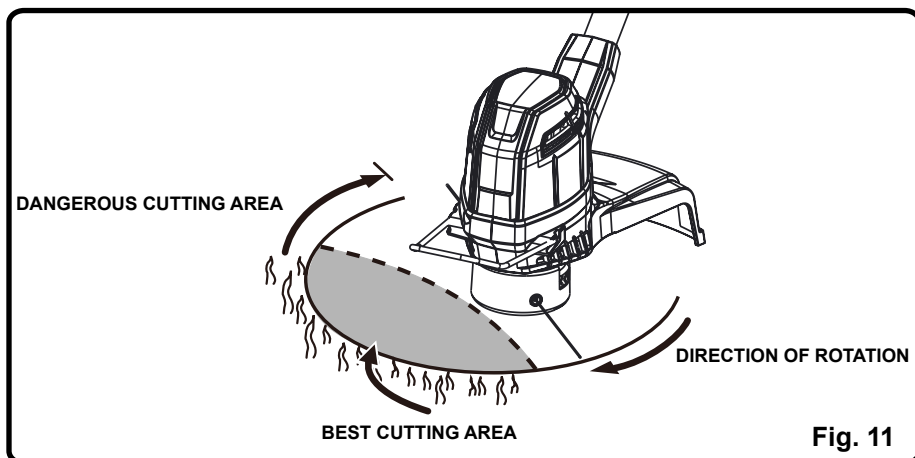

BATTERY & CHARGER MAINTENANCE

CHECKING BATTERY CAPACITY

Press the battery capacity indicator (BCI) button. The lights will illuminate according to the batteries capacity level. See chart below:

BATTERY CAPACITY INDICATOR (BCI) BUTTON

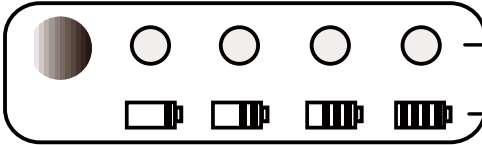

LIGHT METRE

BATTERY METRE

Lights	Capacity
4 Green Lights	The battery is at full capacity
3 Green Lights	The battery is at 75% capacity
2 Green Lights	The battery is at 50% capacity
1 Green Light	The battery is at 25% capacity and requires charging soon
Lights go out	The battery is less than 10% capacity and requires charging immediately

CHARGING PROCEDURE

NOTE: *The battery is not shipped fully charged. It is recommended to fully charge before first use to ensure that maximum run time can be achieved. This lithium-ion battery will not develop a memory and may be charged at any time.*

1. Plug the charger into an AC power outlet.
2. Insert the battery pack (1) into the charger (2).

This is a diagnostic charger. The Charger LED Lights (3) will illuminate in specific order to communicate the current battery status. They are as follows:

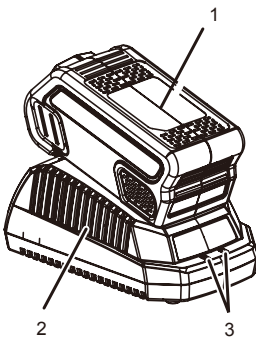

CHARGING PROCEDURE (LED INDICATOR)

BATTERY IS CHARGING:	● RED	● RED
FULLY CHARGED:	● RED	● GREEN
BATTERY IS TOO WARM: <small>(REMOVE FOR APPROX. 30 MINUTES TO ALLOW TO COOL)</small>	● RED	● ORANGE
NO BATTERY PRESENT:	● RED	○ OFF
DEFECTIVE BATTERY: <small>(REMOVE AND REPLACE WITH NEW BATTERY IF THIS OCCURS)</small>	● RED	> ● < > RED < > BLINKING <

False Defect Note: When the battery is inserted into the charger, and the status LED flashes, remove the battery from the charger for 1 minute, then reinsert. If the status LED indicates normal than the battery pack is good. If the status LED is still blinking, remove the battery pack and unplug the charger. Wait 1 minute and plug the charger back in and reinsert the battery pack. If the status LED indicates normal than the battery pack is good. If the status LED is still blinking then the battery pack is defective and needs to be replaced.

BATTERY & CHARGER MAINTENANCE

CHECKING THE CHARGE

If the battery pack does not charge properly:

- Check the current at the power outlet with another tool. Make sure that the outlet is not turned off.
- Check that the charger contacts have not been shorted by debris or foreign material.
- If the surrounding air temperature is not normal room temperature, move the charger and battery pack to a location where the temperature is between 45 °F and 104°F .

⚠ WARNING

If the battery is inserted into the charger when warm or hot, the CHARGING LED indicator light on the charger may switch on and illuminate ORANGE. If this occurs allow the battery to cool outside of the charger from approximately 30 minutes.

CHARGER MOUNTING

1. This charger can be installed hanging on a wall using two screws (not supplied)
2. Locate the placement for the charger to be wall mounted.
3. If fastening to wood studs use 2 wood screws.
4. Drill two holes 2 3/8" (6 cm) on center ensuring they are level.
5. If fastening to drywall use wall anchors and screws to secure the charger to the wall.

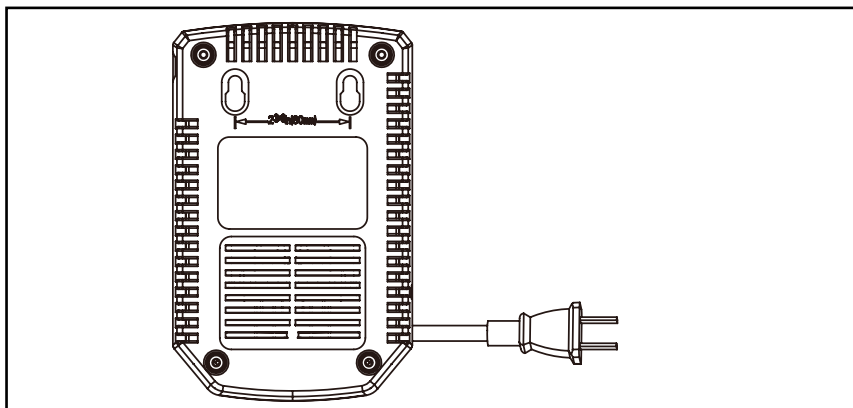

NOTE: If the battery and the charger won't be used for a long time, please remove the battery from the charger and pull out the AC power plug.

MAINTENANCE

GENERAL MAINTENANCE

Avoid using solvents when cleaning plastic parts. Most plastics are susceptible to damage from various types of commercial solvents and may be damaged by their use. Use clean cloths to remove dirt, dust, lubricant, grease, etc.

Always store the machine clean and in a dry enclosure with the battery charged.

Maintenance task	Each time the machine is used	Every two hours	Each week	After use	Every year or when required
Visual check of the tool's safety systems (distancing device, carrying eye, safety casing)	X			X	
Check the trigger safety system functions	X				
Check the sharpness of blades and sharpen if necessary	X	X			X
Visual check of the tool (no cracks or deformation)	X	X			X
Visual check of the tool at the shaft attachment (no deformations or wear)	X	X			X
Check the battery level	X				
Inspection of the tool by an approved Greenworks dealer					X

ENVIRONMENTALLY SAFE BATTERY DISPOSAL

The following toxic and corrosive materials are in the batteries used in this string trimmer battery pack: **Lithium-Ion, a toxic material.**



⚠ WARNING

All toxic materials must be disposed of in a specified manner to prevent contamination of the environment. Before disposing of damaged or worn out Lithium-Ion battery packs, contact your local waste disposal agency, or the local Environmental Protection Agency for information and specific instructions. Take the batteries to a local recycling and/or disposal centre, certified for lithium-ion disposal.

⚠ WARNING

If the battery pack cracks or breaks, with or without leaks, do not recharge it and do not use. Dispose of it and replace with a new battery pack. **DO NOT ATTEMPT TO REPAIR IT!** To avoid injury and risk of fire, explosion, or electric shock, and to avoid damage to the environment:

- Cover the battery's terminals with heavy-duty adhesive tape.
 - DO NOT attempt to remove or destroy any of the battery pack components.
 - DO NOT attempt to open the battery pack.
 - If a leak develops, the released electrolytes are corrosive and toxic. DO NOT get the solution in the eyes or on skin, and do not swallow it.
 - DO NOT place these batteries in your regular household trash.
 - DO NOT incinerate.
 - DO NOT place them where they will become part of any waste landfill or municipal solid waste stream.
 - Take them to a certified recycling or disposal centre.
-

TROUBLESHOOTING

Problem	Cause	Solution
String trimmer fails to start.	1. The battery pack is not attached to the trimmer.	1. Attach the battery pack to the trimmer.
	2. No electrical contact between the trimmer and battery.	2. Remove battery check contact and reinstall the battery pack.
	3. The battery pack is depleted.	3. Charge the battery pack.
	4. The lock-off lever and trigger are not depressed simultaneously.	4. Press down the lock-off lever and hold it, then depress the trigger to turn on the string trimmer.
	5. Did not press the power button, press the trigger directly.	5. Start the power button, the power indicator will trigger later.
String trimmer stops while cutting.	1. The guard is not mounted on the trimmer, resulting in an overly long cutting and motor overload.	1. Remove the battery pack and mount the guard on the trimmer.
	2. Heavy cutting line is used.	2. Use only with nylon cutting line 0.065" diameter or less.
	3. The motor shaft or trimmer head is bound with grass.	3. Stop the trimmer, remove the battery, and remove the grass from the motor shaft and trimmer head.
	4. The motor is overloaded.	4. Remove the trimmer head from the grass.the motor will recover to work as soon as the load is removed. when cutting, move the trimmer head in and out of the grass to be cut and remove no more than 8 inches of length in a single cut.
	5. The battery pack or string trimmer is too hot.	5. Allow the battery pack to cool until the temperature drops below 158°F (70°C). Allow the trimmer to cool until the temperature drops below 140°C.
	6. The battery pack is disconnected from the tool.	6. Re-install the battery pack.
	7. The battery pack is depleted.	7. Charge the battery pack.

TROUBLESHOOTING

Problem	Cause	Solution
Trimmer head will not advance line.	1. The motor shaft or trimmer head is bound with grass.	1. Stop the trimmer, remove the battery, and clean the motor shaft and trimmer head.
	2. There is not enough line on the spool.	2. Remove the battery and replace the cutting line; follow the section "line replacement" in this manual.
	3. The trimmer head is dirty.	3. Remove the battery and clean the spool, spool retainer and spool base.
	4. The line is tangled on the spool.	4. Remove the battery, remove the line from the spool and rewind; follow the section "line replacement" in this manual.
	5. The line is too short.	5. Remove the battery and pull the lines while alternately pressing down on and releasing the bump knob.
	6. Bump head hit on the grass.	6. Remove bump head hit on the ground.
Line keeps breaking.	1. Trimmer used incorrectly.	1. Only trim with the tip of the line, avoid stones, walls and other hard objects. Feed the line regularly to maintain full cutting width.
Grass wraps around trimmer head and motor housing.	1. Cutting tall grass at ground level	1. Cut tall grass from the top down, removing no more than 8 inches in each pass to prevent wrapping.
Line is not cutting well	1. The line-cutting blade on the edge of the guard has become dull.	1. Sharpen the line-cutting blade with a file or replace it with a new blade.

LIMITED WARRANTY



GREENWORKS™ hereby warranties this product, to the original purchaser with **proof of purchase**, for a period of four (4) years against defects in materials, parts or workmanship. GREENWORKS™, at its own discretion will repair or replace any and all parts found to be defective, through normal use, free of charge to the customer. This warranty is valid only for units which have been used for personal use that have not been hired or rented for industrial/ commercial use, and that have been maintained in accordance with the instructions in the owners' manual supplied with the product from new.

Battery carries a two (2) year warranty against defects in workmanship and materials. Batteries must be charged in accordance with the operator's manuals directions and regulations in order to be valid.

ITEMS NOT COVERED BY WARRANTY:

1. Any part that has become inoperative due to misuse, commercial use, abuse, neglect, accident, improper maintenance, or alteration; or
2. The unit, if it has not been operated and/or maintained in accordance with the owner's manual; or
3. Normal wear, except as noted below;
4. Routine maintenance items such as lubricants, blade sharpening;
5. Normal deterioration of the exterior finish due to use or exposure.

GREENWORKS HELPLINE (1 888 90WORKS):

Warranty service is available by calling our toll-free helpline, at **1-888-909-6757 (1-888-90WORKS)**.

TRANSPORTATION CHARGES:

Transportation charges for the movement of any power equipment unit or attachment are the responsibility of the purchaser. It is the purchaser's responsibility to pay transportation charges for any part submitted for replacement under this warranty unless such return is requested in writing by **GREENWORKS**.

EXPLODED VIEW

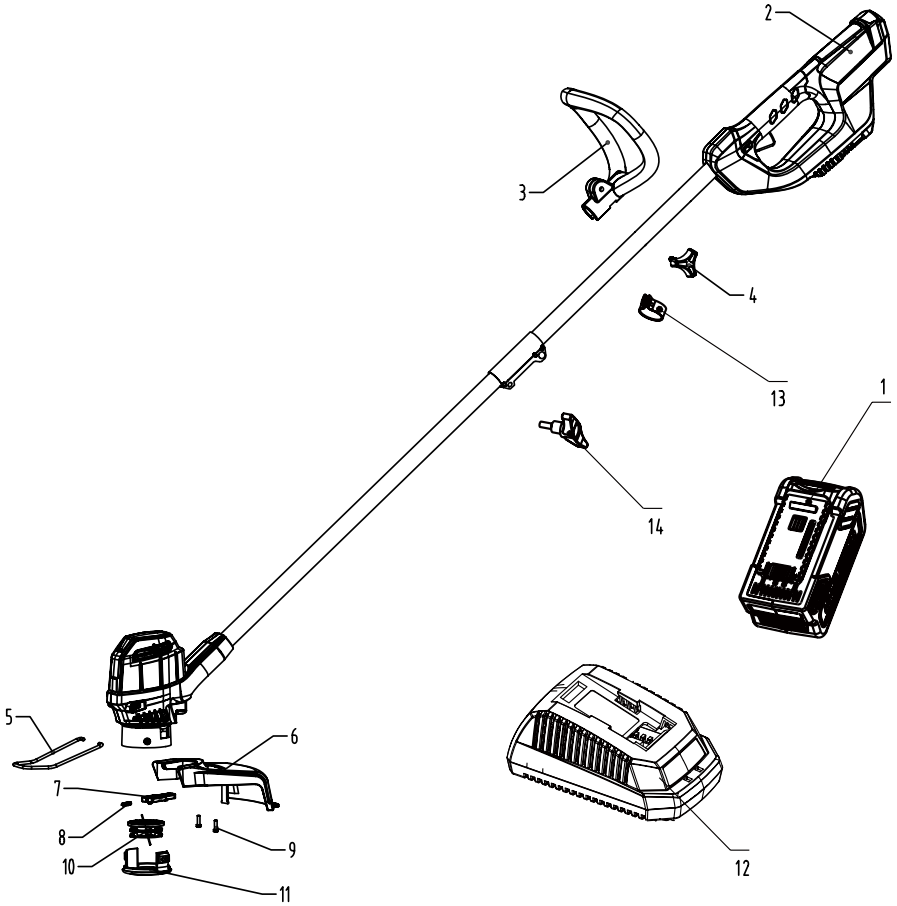

PARTS LIST

Item No.	Part No.	Description	QTY
1	31103976(BK) (29462)	(G-MAX) 40V 2Ah battery	1
2	2101602	Bare tool assembly	1
3	34105874	Auxiliary handle	1
4	34116884AB	Auxiliary handle knob	1
5	333011426	Edge guide	1
6	341041426	Guard	1
7	34120186	Button	1
8	3340646A	Spring	1
9	3220313-3	Screw ST4x14-F	2
10	31101724	Spool	1
11	34121186-2	Spool cover	1
12	31102998 (29482)	(G-MAX) Charger	1
13	33306874	Metal ring	1
14	34107511AC	Knob	1



TOLL-FREE HELPLINE: 1-888-90WORKS (888.909.6757)

Rev: 00 (08-04-15)

 Printed in China on 100% Recycled Paper