

Assembly Instructions

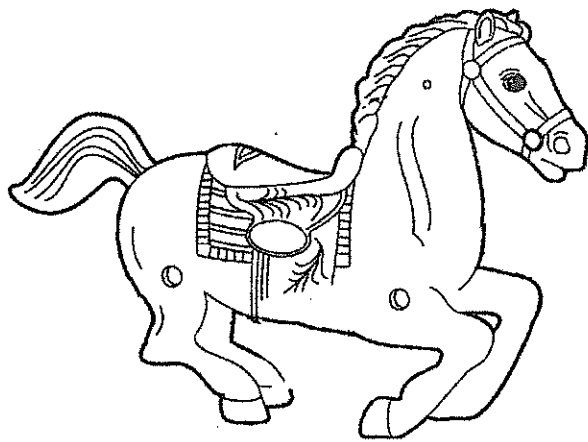

A 1PC

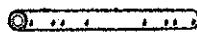

B 1PC

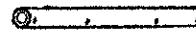

C 1PC



D 2PCS

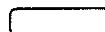

E 2PCS



F 4PCS



G 2PCS



H 4PCS

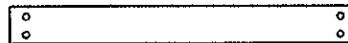

I 2PCS

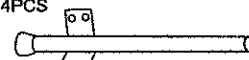

J₁ 2PCS

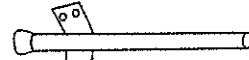

J₂ 2PCS



K 16PCS



L 20PCS



M 20PCS



N 4PCS



O 4PCS

Figure 1

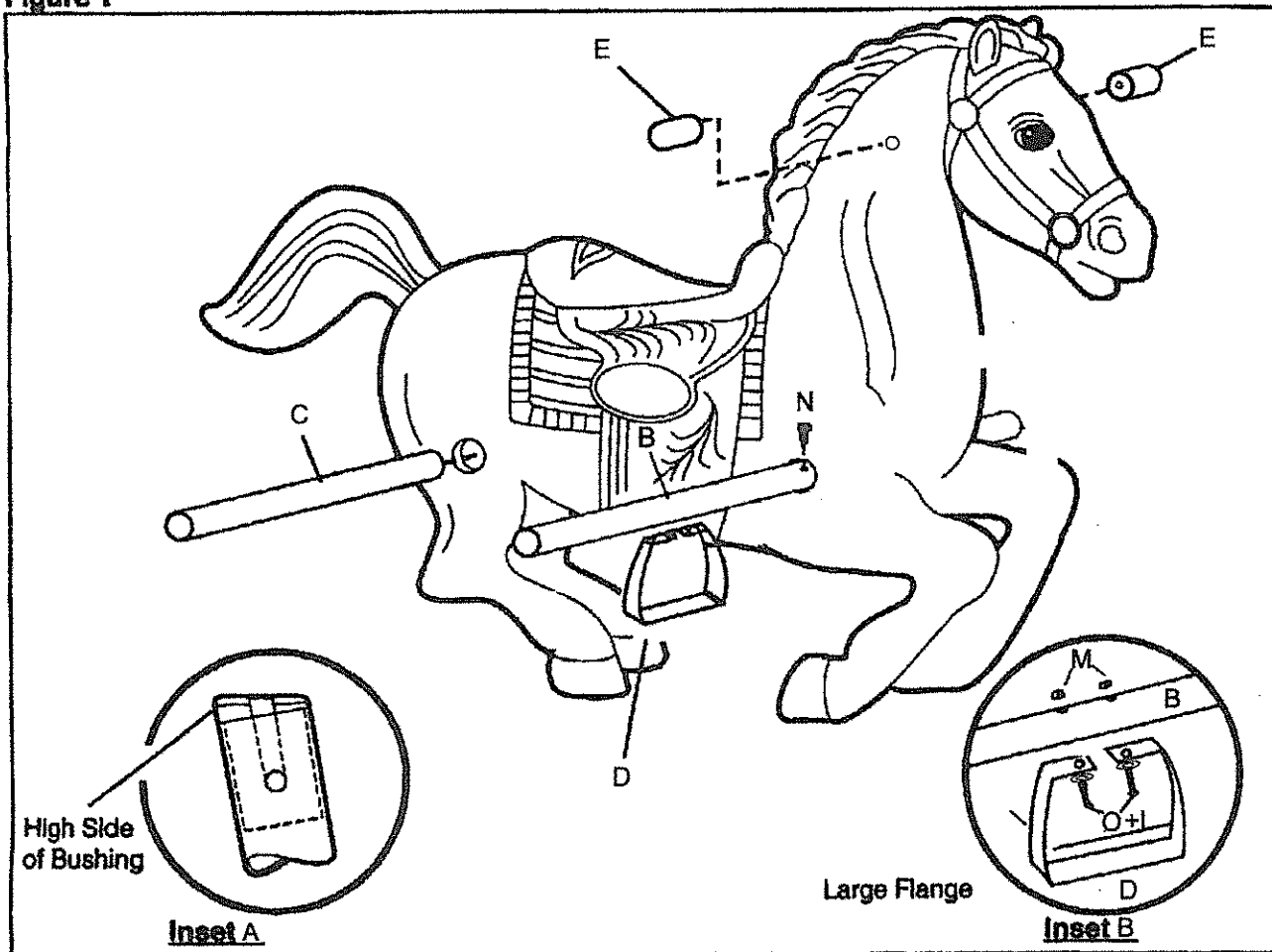

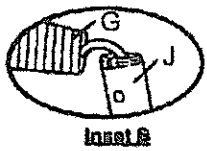
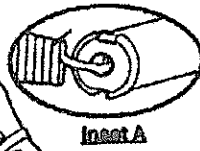
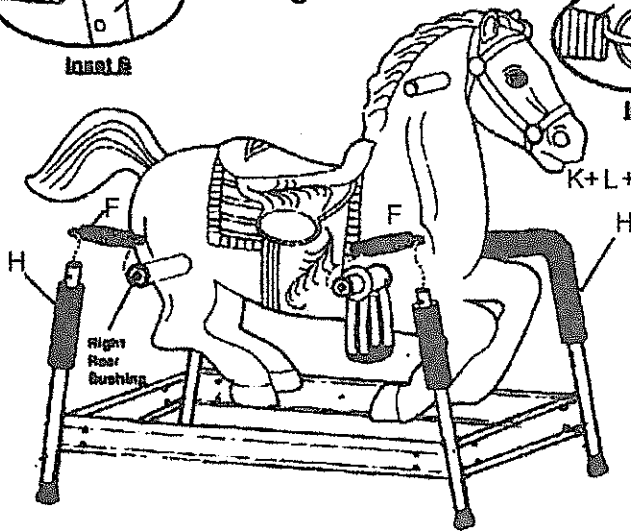

Figure 3



Inset A

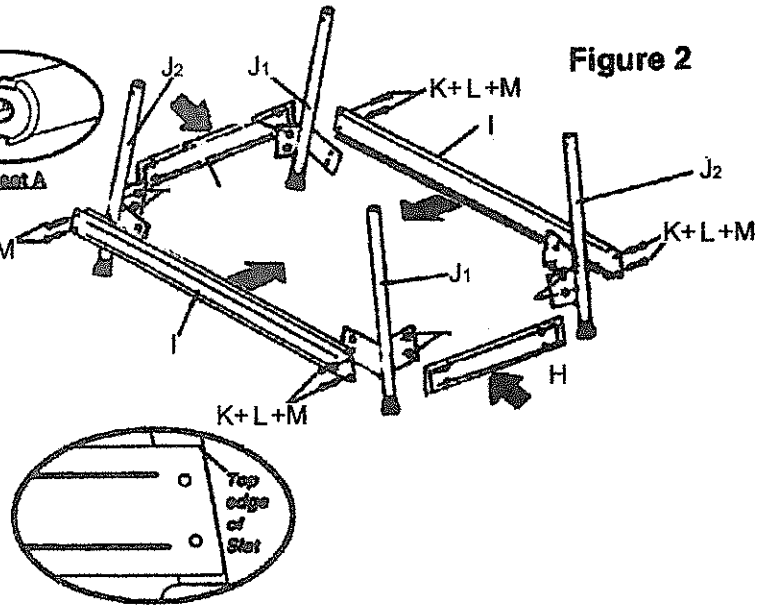
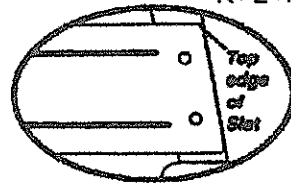

Figure 2



BODY TUBE ASSEMBLY:

IMPORTANT:

Make sure mounting holes are lined up and high side of each Bushing faces towards center of the Cattle body.

1. With high side of attached Bushing facing towards the center of Cattle Body, slide Body Tubes into front and rear holes on Cattle Body. See Figure 1 Inset A.
2. Attach a Stirrup (D) to ends of front Body Tube with large flange facing away from Horse Body. See Figure 1 Inset B.
3. Secure each Bushing with Screw (N) and Lockwasher (L). See Figure 1.
4. Center Front and Rear Body Tubes and use Screws (N) on each side of tube at hole closest to Cattle Body.

HEAD TUBE ASSEMBLY:

1. Screw in the two Handles into the holes located on the neck of the Cattle.

FRAME SLAT ASSEMBLY:

1. Attach Frame Slats (I) between Leg Tubes (J1 J2) using Screws (K) and Capnuts (M). See Figure 2 Inset A.
2. Attach Frame Slats (G) between Leg Tubes (J1 J2). See Figure 2 Inset A.

COVER & SPRING ASSEMBLY:

1. Slide Spring Covers (H) over Leg Tubes. Make sure Spring Covers are down far enough to reveal Bushing in end of Leg Tubes.

Note: For ease of assembly apply a small amount of window cleaner to Body Tubes and Leg Tubes before attaching Spring Covers.

2. Place Cattle Body on floor in middle of Frame.
3. Hook end of Spring into right rear Body Tube Bushing. See Figure 3 Inset A.
4. Hook other end of Spring into Bushing in Leg Tube. See Figure 3 Inset B.
5. Hook end of Spring into left front Body Tube Bushing. See Figure 3 Inset A.
6. Hook other end of Spring into Bushing in Leg Tube. See Figure 3 Inset B.
7. Repeat Steps 3 through 6 above for attaching left rear and then right front Springs.

IMPORTANT: Make sure hooked end of Springs (F) are fully inserted into Bushings.

8. Slide rear Spring Covers until they touch Cattle Body.
9. Slide front Spring Covers until end touches Stirrup.

Note: Battery pack is located in stomach.

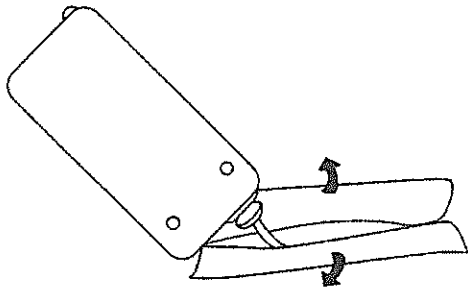

Tear off the bottom velcro and take out the battery.

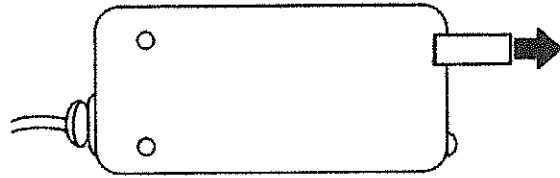

Remove the safe plastic on battery.



Press the mark on animal hand, then it will make noise.

**ADULT SUPERVISION IS RECOMMENDED
REMOVE ALL PLASTIC
FASTENERS AND HANG TAGS
BEFORE GIVING TOY TO CHILD.
THESE ATTACHMENTS ARE
NOT PART OF THE TOY.
COLORS AND CONTENTS MAY VARY
RATIONS**

FOR BEST PERFORMANCE:

- Use only the batteries recommended.
- Do not mix alkaline, standard (carbon-zinc), or rechargeable (nickel-cadmium) batteries.
- Do not mix new and used batteries together.
- Remove batteries when toy is not in use.
- Remove exhausted batteries from toy and dispose of in accordance with the battery manufacturer's recommendation.
- Do not attempt to recharge non-rechargeable batteries.
- Do not use rechargeable batteries.
- Batteries are to be inserted with the correct polarity.
- The supply terminals are not to be short-circuited.

**ADULT SUPERVISION IS RECOMMENDED
WHEN CHANGING BATTERIES.**

Max weight 60kg.

ATTENTION:The batteries included in this item are intended for in-store use. It is possible that these batteries may become weak or discharged prior to purchase and the customer may need to replace the batteries with fresh cells to insure proper operation.

WARNING

Manufacturer and seller expressly disclaim any and all liability for personal injury, property damage or loss, whether direct, indirect, or incidental, resulting from the incorrect attachment, improper use, inadequate maintenance, or neglect of this product.



Made In China