

Follow this flight path

1

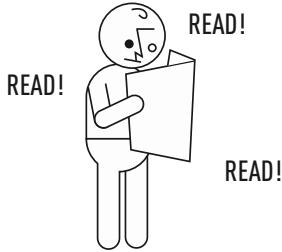

READ THESE INSTRUCTIONS!

Follow these steps for a successful assembly. If you still have questions, we're here to help. Please contact our Prevue Customer Service team via email at : customerservice@prevuepet.com

2

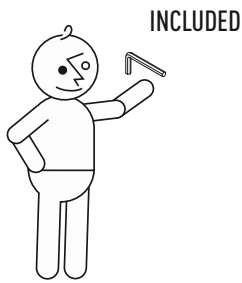

HELPFUL TOOLS

The entire cage can be assembled with the allen wrench included in this kit. Optional tools which may be helpful at a couple points include a **flathead screwdriver** and **rubber mallet** (see Step 2), and a small **adjustable crescent wrench** (see Step 6).

OPTIONAL

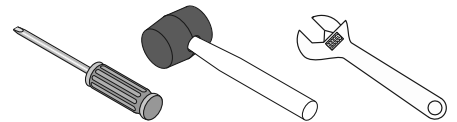

3

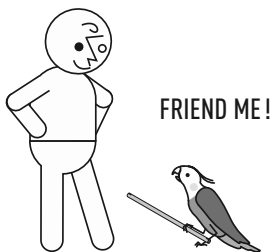

FIND A FRIEND

A second person's assistance is a necessity during several stages of this cage assembly. Look for this symbol:



4

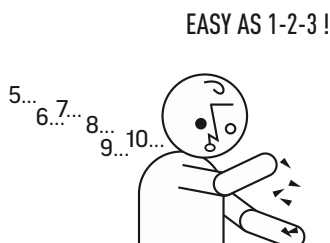

REVIEW ALL PARTS & HARDWARE

After unpacking all components, review all parts and count the contents of the screw packets and compare the quantities against the Hardware Included list on the other side.

Please contact Prevue if any problems or issues arise.

5



CARE FOR BIRDS

CAGE PLACEMENT

Place the cage away from drafts and drafty areas and away from harsh or direct sun. Keep the cage away from strong fumes and odors.

ACTIVITY TOYS

Activity toys are vital for maintaining a bird's mental and physical health. Select a variety of toys to meet different instinctual activities—foraging, grooming, sound, movement, discovery, and more. Regularly rotate new and familiar toys through the cage. Do not overcrowd the cage environment. Periodically supervise birds at play and inspect toys for replacement or replenishment. Prevue offers a wide range of activity toys for birds of all sizes.

ACCESSORIES

Add or upgrade accessories to promote health. Add variable-shape perches. Use cage covers to quiet and calm birds at night or for high-traffic areas. Search www.prevuepet.com for useful accessories for birds and their cage environment.

TRAVEL CARRIERS

Always keep an appropriate size travel carrier on hand for emergencies, travel or temporary housing when cleaning the cage. Prevue has several carrier options available—from softcase to wrought iron.

PREVUE PET PRODUCTS

PHONE 1 (312) 243-3624

ONLINE www.prevuepet.com

EMAIL customerservice@prevuepet.com

These instructions are online, under the item's detail listing at www.prevuepet.com.



For more wonderful cages, toys,
and accessories for dogs, cats, birds,
chickens, rabbits, ferrets and small
animals, visit www.prevuepet.com



Empire Cage PARTS LIST

Instructions online at www.prevuepet.com

CUSTOMER SUPPORT

Please contact Prevue Pet Products:

PHONE 1 (312) 243-3624

ONLINE www.prevuepet.com

EMAIL customerservice@prevuepet.com

KEY:

C = Center (Roof) Panels

F = Front Panels

B = Back Panels

L = Left Side Panels

R = Right Side Panels

G = Grille

T = Tray

SG = Seed Guards

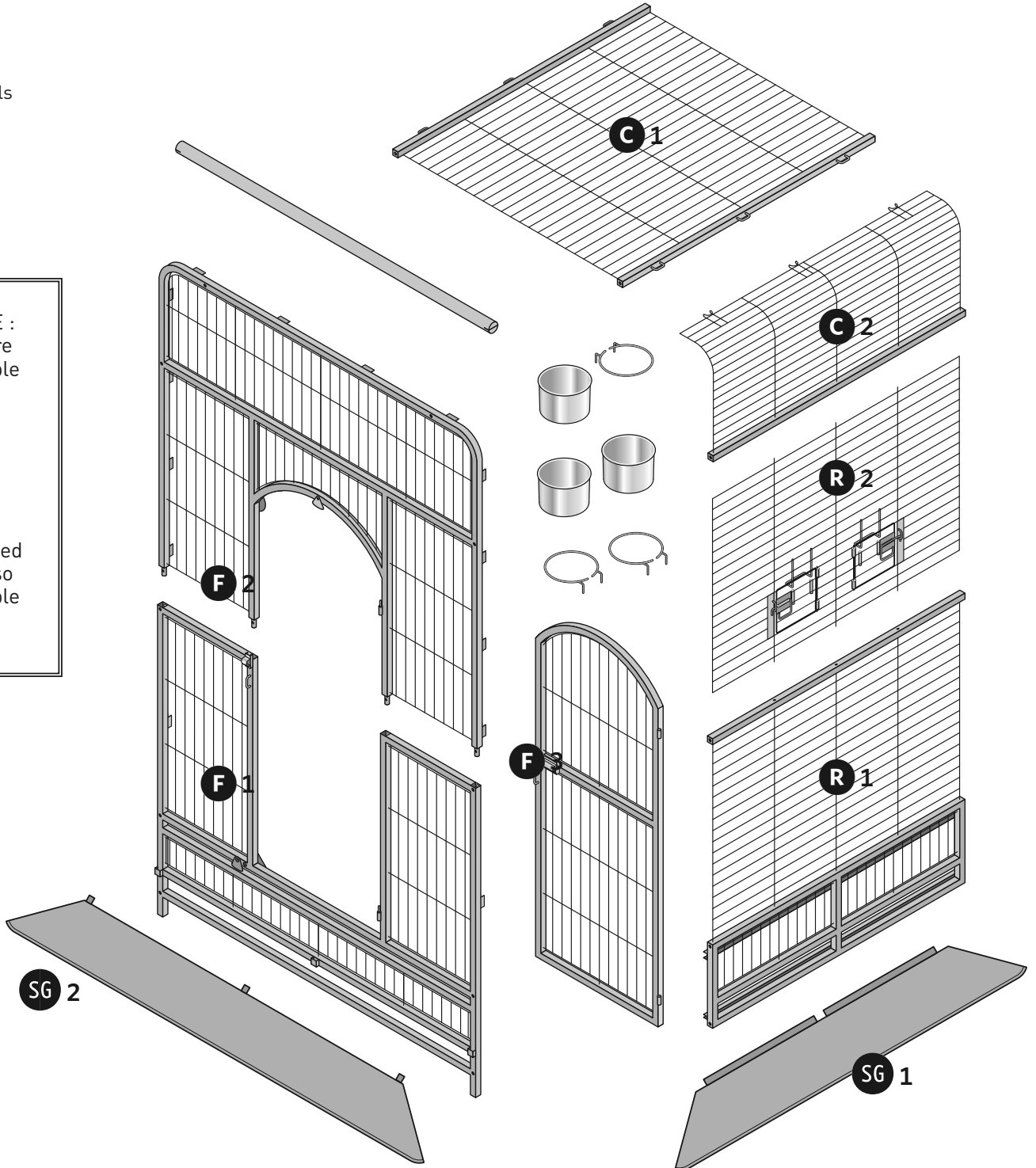

PLEASE NOTE :
Side panels are interchangeable

C 3 = C 2
L 2 = R 2
L 1 = R 1
SG 4 = SG 1
 Front/Back seed guards are also interchangeable

SG 2 = SG 3



Empire Cage PARTS LIST

Instructions online at www.pvuepet.com

CUSTOMER SUPPORT

Please contact Prevue Pet Products:

PHONE 1 (312) 243-3624

ONLINE www.pvuepet.com

EMAIL customerservice@prevuepet.com

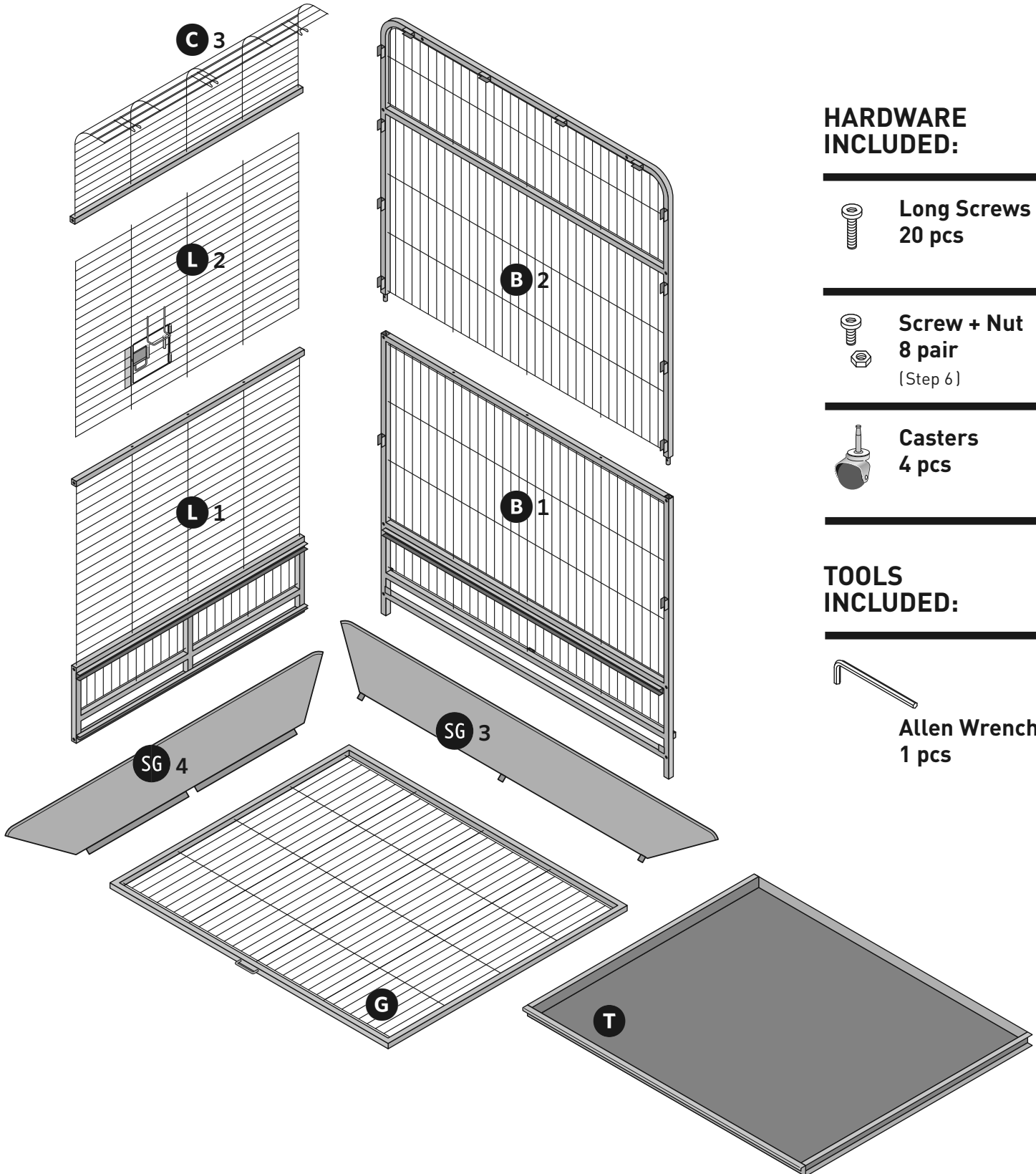

HARDWARE INCLUDED:

 **Long Screws**
20 pcs

 **Screw + Nut**
8 pair
(Step 6)

 **Casters**
4 pcs

TOOLS INCLUDED:

 **Allen Wrench**
1 pcs



Empire Cage ASSEMBLY

Instructions online at www.prevuepet.com

CUSTOMER SUPPORT

Please contact Prevue Pet Products:

PHONE 1 (312) 243-3624

ONLINE www.prevuepet.com

EMAIL customerservice@prevuepet.com

For best results, follow the Assembly Steps in the order presented.

KEY:

- F = Front Panels
- B = Back Panels
- L = Left Side Panels
- R = Right Side Panels
- C = Center (Roof) Panels
- G = Grille
- T = Tray
- SG = Seed Guards

1 PIECES

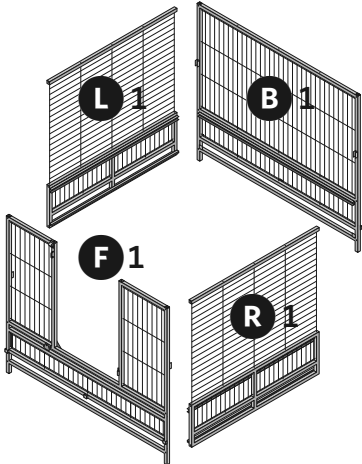

In most cases, we recommend two people assemble this cage.

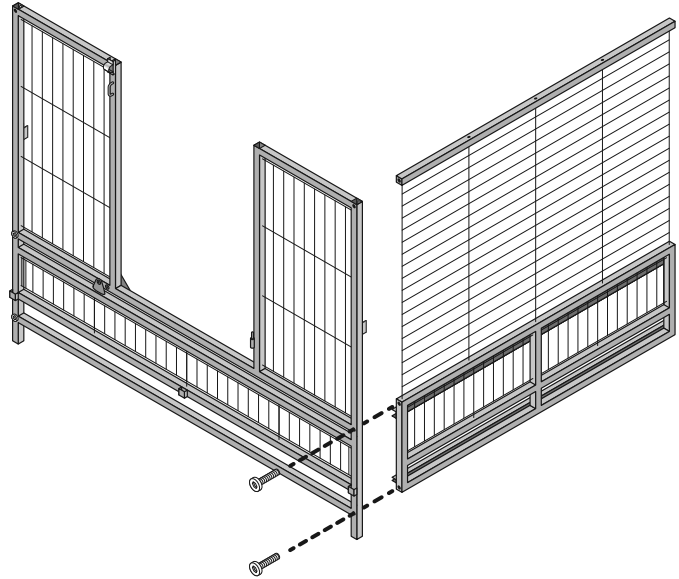

Align the lower front panel with the lower right side panel. Attach the panels together with long screws.

Grille/tray tracks on all side panels should face the interior.

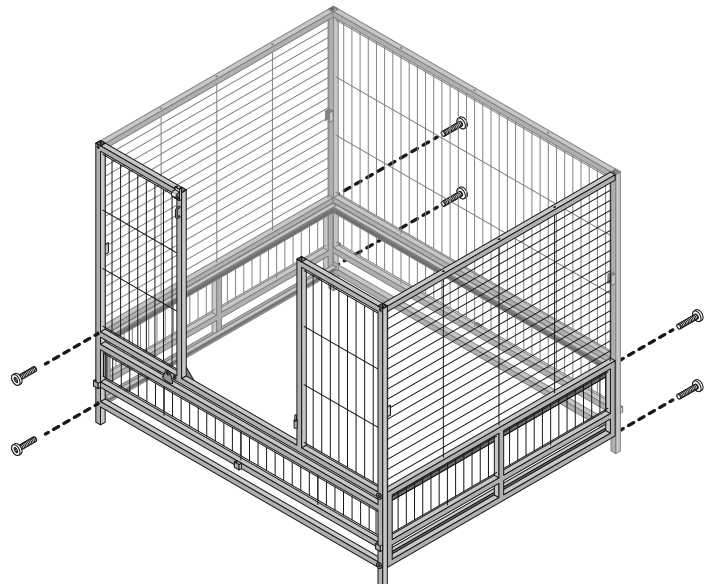

Continue attaching all lower panels together with long screws.

2 PIECES

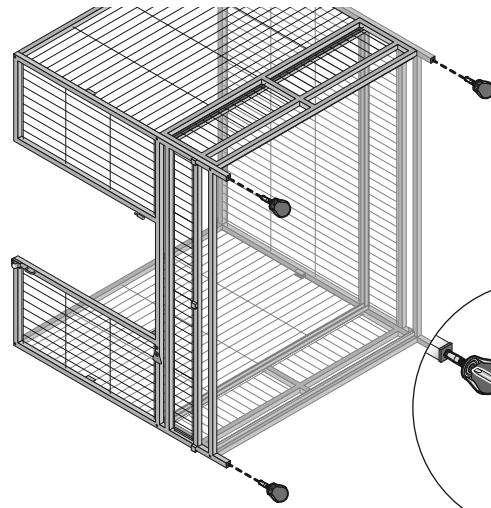
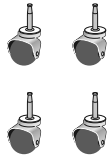

Carefully lay the cage on its side. Insert the casters by hand.

If casters do not insert fully, position a flathead screwdriver at the caster base and gently tap the caster in place with a rubber mallet.

After caster installation, carefully upright the cage and continue with assembly.

OPTIONAL

3 PIECES

[4] LONG

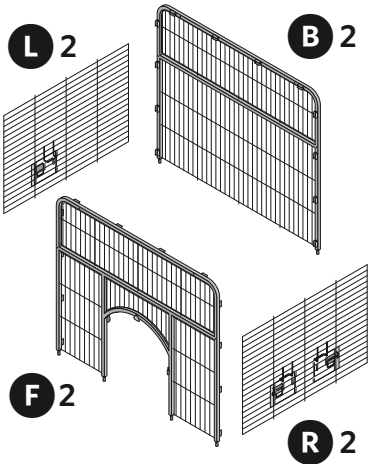

Insert the corner posts of the **upper back panel** into the frame rail holes of the lower back panel. Align and insert the extended vertical wires into the holes in the horizontal frame rail. Attach the back panels together with long screws.

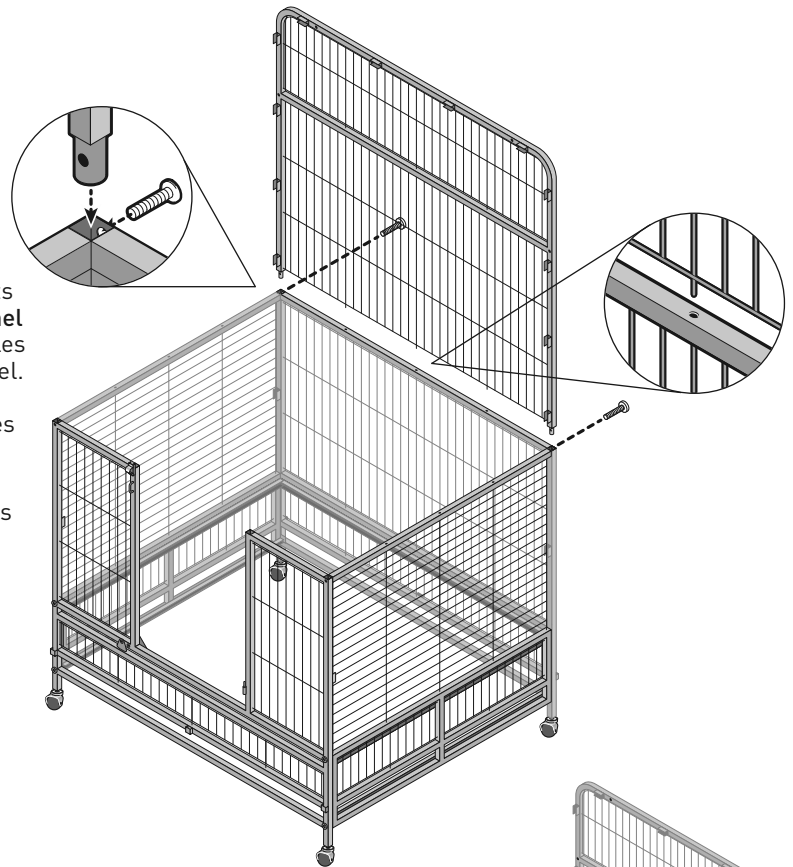

Slide the corner posts of the **upper front panel** into the frame rail holes of the lower front panel. Attach the panels together with long screws.

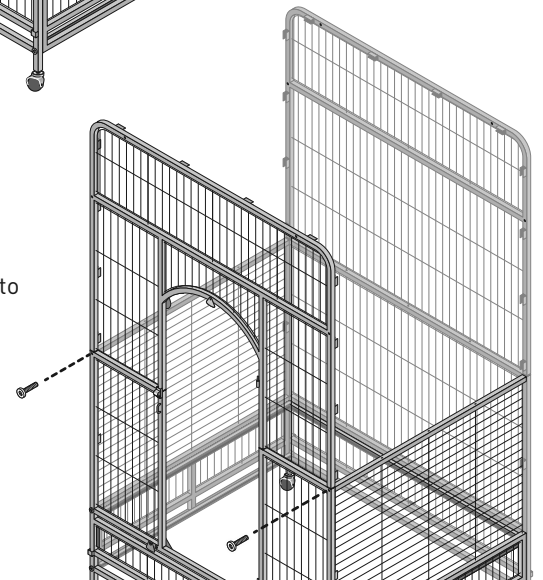

3 ...continued

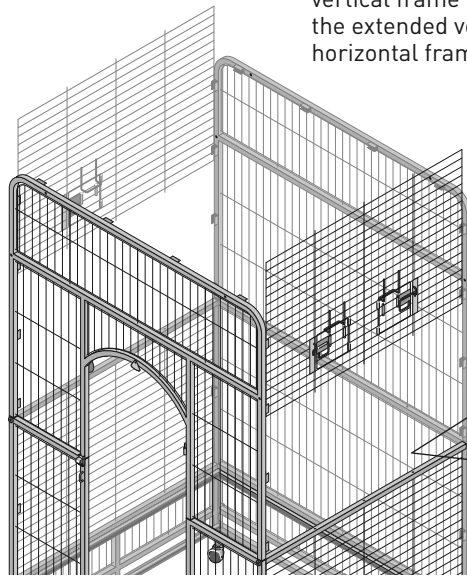
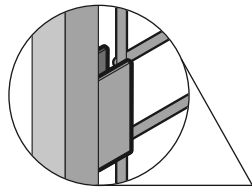

Slide the **upper side panels** down through the vertical frame rail channels. Align and insert the extended vertical wires into the holes in the horizontal frame rails.

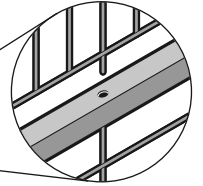

4 PIECES



 [8] LONG

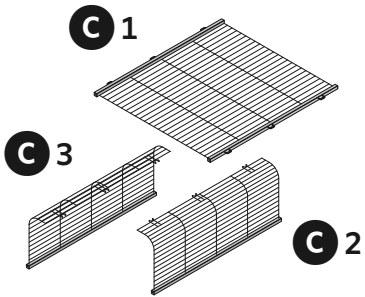

Guide the **top roof panel** into the channels on the horizontal frame rails. **LOOSELY** attach the roof with long screws.

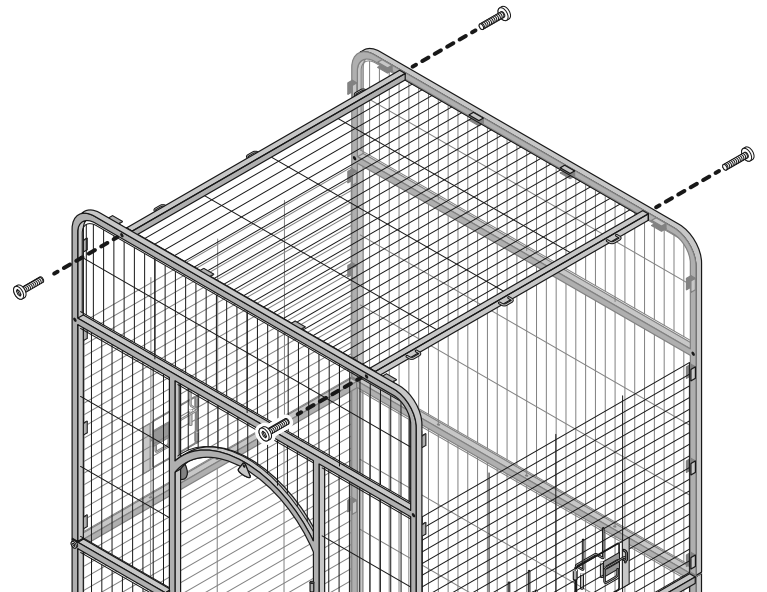

Hook the loops of the **side roof panels** onto the loops along the horizontal frame rail of the main roof panel. Swing the side roof panel down, align and insert the extended vertical wires of the lower panel into the holes on the underside of the frame rail.

Attach the side roof panels with long screws. Tighten the screws for the main roof panel.

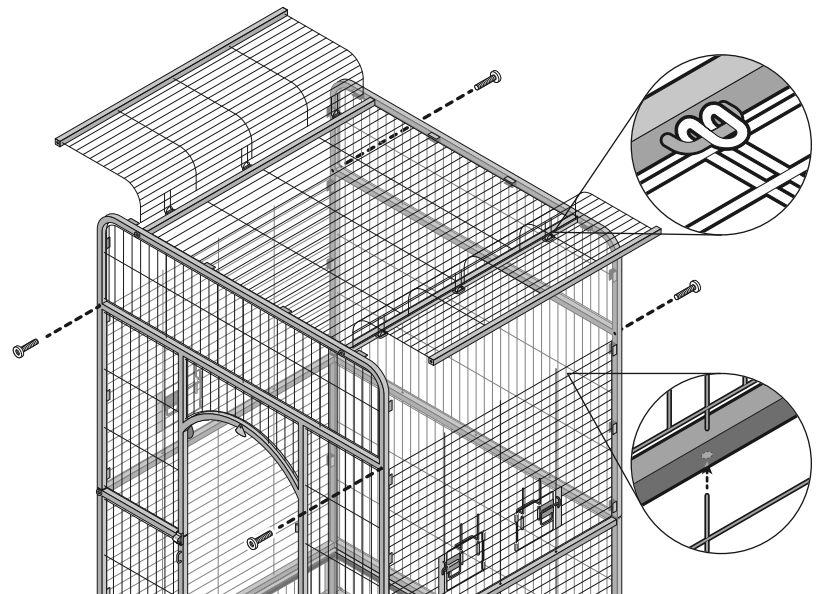

5 PIECES

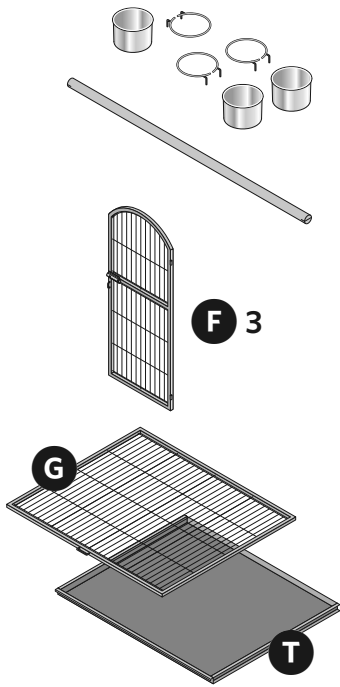

DOOR

Install the front door by aligning and inserting the sleeves on the door into the posts on the frame rails.

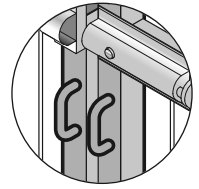
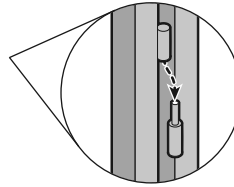
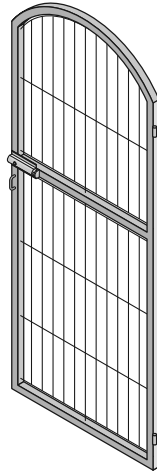

The door may be padlocked for security (padlock not included).

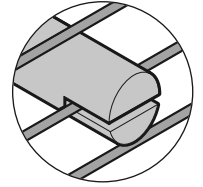

PERCH

Install the perch on corresponding-height horizontal wires.

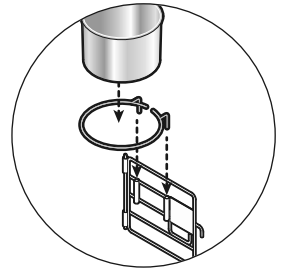

CUPS

Open the cup doors. Insert the cup holder. Insert cups into the cup holders.



GRILL + TRAY

Rotate the windbell lock out of the way, and insert the floor grille. Insert the debris tray in the lower channel.

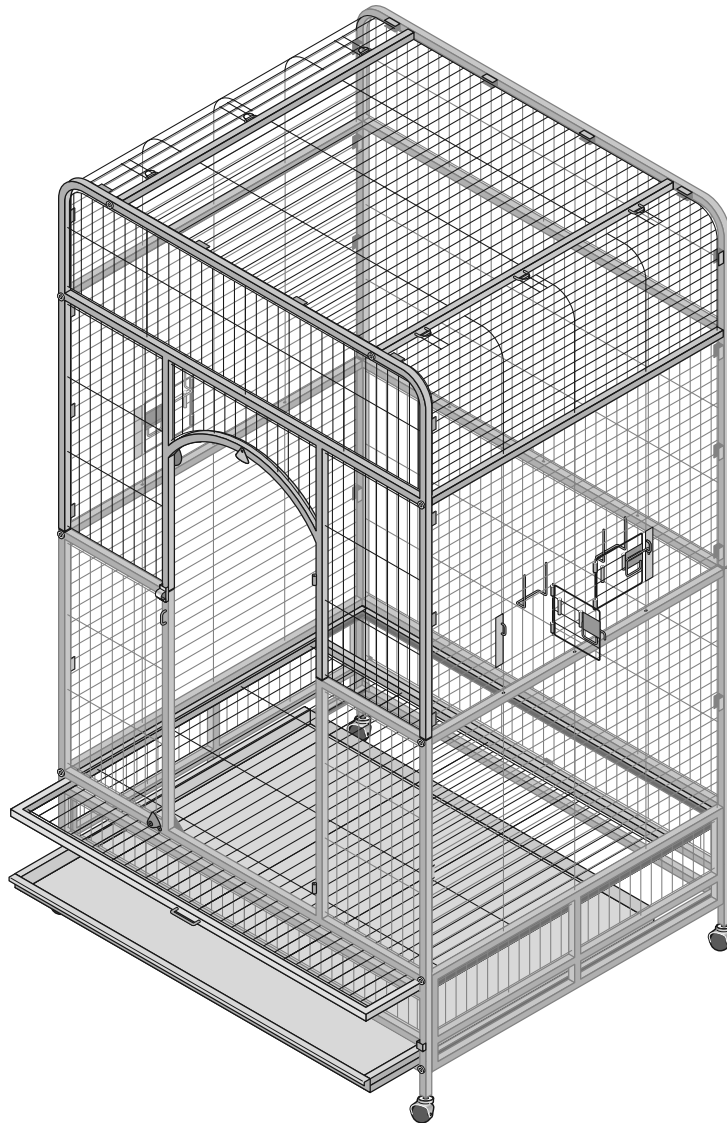

6 PIECES

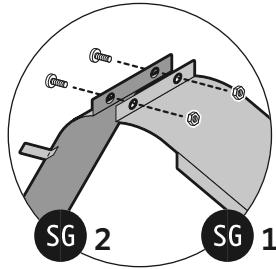
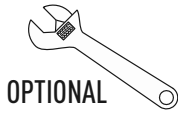
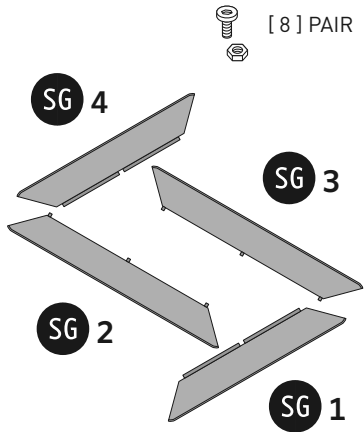

Pre-assemble the right side seed guard to the front seed guard.
Pre-assemble the left side seed guard to the back seed guard.

Insert the assembled seed guard sections onto the cage.
Finish by attaching the open ends with the remaining screw/nut pairs.

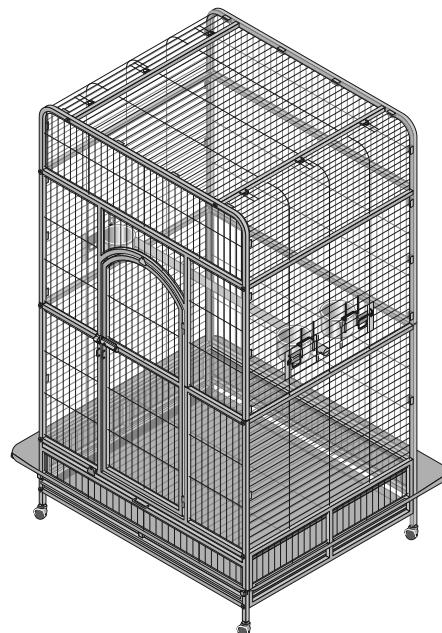
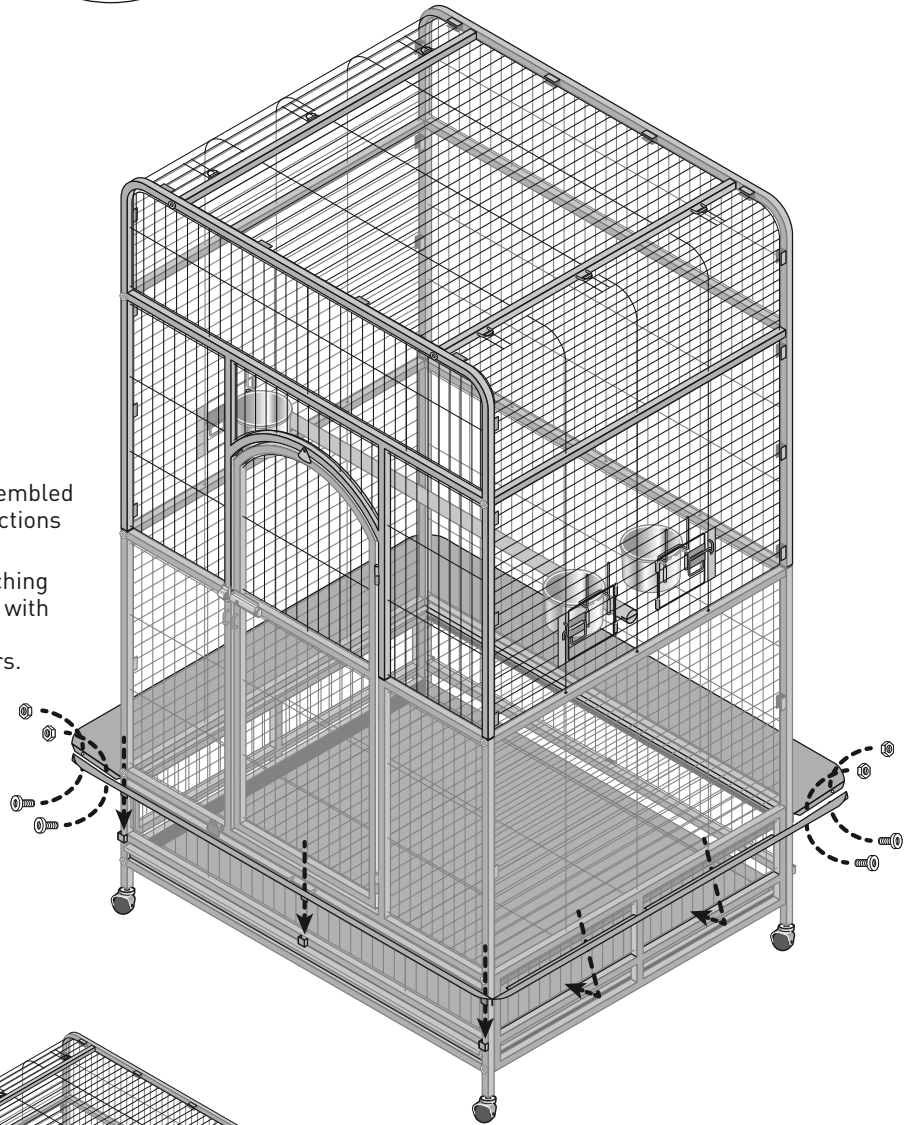

When fully assembled, check and tighten ALL screws over the entire cage to ensure a safe and stable home.

Assembly completed. ■