



COMPACT ELECTRIC LEAF BLOWER

6-AMP | 155-MPH

OPERATOR'S MANUAL

A Division of Snow Joe®, LLC

Model SBJ597E

Form No. SJ-SBJ597E-880E-MR3

IMPORTANT! Safety Instructions

All Operators Must Read These Instructions Before Use

Any electrical appliance can be dangerous if used incorrectly. Some of the safety precautions given in this manual apply generally to many appliances. Other warnings are specific to the use of this electric blower.

Always follow these safety guidelines. Failure to do so may result in serious bodily injury or death.

⚠ DANGER! This indicates a hazardous situation, which, if not followed, will result in serious injury or death.

⚠ WARNING! This indicates a hazardous situation, which, if not avoided, could result in serious injury or death.

⚠ CAUTION! This indicates a hazardous situation, which, if not avoided, could result in minor or moderate injury.

General Safety

FOR HOUSEHOLD USE ONLY

Before using, be sure that everyone using this tool reads and understands all safety instructions and other information contained in this manual. Save this manual and review it frequently prior to using this tool and when instructing others on the proper operating procedures.

⚠ CAUTION! Wear appropriate hearing protection during use. After long periods of extended use, the noise generated from this appliance may cause hearing loss if your ears are not properly protected.

⚠ WARNING! When using electric yard tools, basic safety precautions should always be followed to reduce the risk of fire, electric shock, and personal injury, including the following:

- 1. Keep work area clean and well-lit** – Cluttered, dark areas invite accidents.
- 2. Replacement parts** – When servicing this unit, use only identical replacement parts. Replace or repair damaged cords immediately.
- 3. Keep children, bystanders, and pets away** – All spectators, including pets, should be kept a safe distance away from the work area.

- 4. Dress properly** – Do not wear loose clothing or jewelry as such articles can get caught in moving parts. Wear a protective covering to contain long hair. Wearing rubber gloves and substantial non-slip footwear is recommended when working outdoors.
- 5. Extension cords** – To prevent electric shock, use only with an extension cord suitable for outdoor use.
- 6. Avoid accidental starting** – Do not carry the blower with your finger on the switch. Make sure the switch is off before plugging in the unit.
- 7. Do not abuse the cord** – Never carry the blower by the cord or yank the cord to disconnect it from the receptacle. Keep the cord away from heat, oil, and sharp edges.
- 8. Moving parts** – Keep hands and feet away from moving parts. Keep guards in place and in proper working order.
- 9. Do not force the tool** – It will perform better with less likelihood of personal or mechanical injury if it is used at the rate for which it is designed.
- 10. Wear personal protective equipment** – When using this tool, wear safety glasses with side shields or goggles to provide necessary eye protection. Wear ear defenders to prevent hearing damage. Use a face or dust mask if the work environment is dusty.
- 11. Disconnect the tool** – Disconnect the blower from the power supply when it is not in use, before servicing it, when changing accessories, and when performing any other maintenance task.
- 12. Store idle tool indoors** – When not in use, the blower should be stored indoors in a dry and high or locked-up place out of the reach of children.
- 13. Maintain the blower with care** – Keep the blower tube and the fan area clear and clean for optimal performance and to reduce the risk of injury. Inspect the extension cord periodically and immediately replace it if damaged. Keep the handles dry, clean, and free from oil and grease. Follow the additional recommendations described in the maintenance section of this manual.
- 14. Ground fault circuit interrupter (GFCI) protection** should be provided on the circuit(s) or outlet(s) that are to be used for the blower. Receptacles are available having built-in GFCI protection and may be used for this measure of safety.
- 15. Use the right tool** – Do not use the tool for any job except that for which it is intended.
- 17. Avoid dangerous environments** – Do not use the blower in rain, damp, or wet locations.

- 18. **Stay alert** – Watch what you are doing. Use common sense. Do not operate the blower when you are tired or under the influence of drugs, alcohol, or other medication.

Additional Safety Instructions

- Do not use the blower in the rain or in a damp area.
- Use extra care when cleaning on stairs.
- Do not use to pick up flammable or combustible liquids, such as gasoline, or use in areas where they may be present.
- Do not allow to be used as a toy. Close attention is necessary when used by or near children.
- Keep firm footing and maintain good balance at all times. Do not overreach. Overreaching can result in loss of balance.
- Turn off all controls before unplugging the tool.
- Do not use the tool if the power switch does not turn it ON or OFF. Any tool that cannot be controlled with the switch is dangerous and must be repaired.
- Do not use the tool with a damaged plug. If the tool is not working as it should or has been dropped, damaged, left outdoors, or dropped into water, return it to an authorized Snow Joe® + Sun Joe® dealer or contact the Snow Joe® + Sun Joe® customer service department at 1-866-SNOWJOE (1-866-766-9563).
- Carefully inspect your appliance prior to use and follow all label and marking instructions.
- Keep all parts of your body away from any moving parts and all hot surfaces of the unit.
- Do not put any object into the tool's openings. Do not use the tool with any opening blocked; keep openings free of dust, lint, hair, or any other object that may reduce air flow.
- Check the work area before each use. Remove all objects such as rocks, broken glass, nails, wire, or string, which can be thrown or become entangled in the machine.
- Service on the product must be performed by qualified repair personnel only. Service or maintenance performed by unqualified personnel could result in injury to the user or damage to the product.
- This blower is intended for residential use only. Commercial use of this product is prohibited and will void the manufacturer's warranty.
- Never run the unit without the proper equipment attached. Always ensure the blower tubes are properly installed.
- Always grasp both handles when operating the unit, only operate the machine in its intended orientation.

Specific Safety Rules For Blower

- The blower has been designed to clear light debris and leaves from hard surfaces, not for clearing grassed areas.
- When operating the unit, never point the blower nozzle in the direction of people or pets or in the direction of

windows. Use extra caution when blowing debris near solid objects, such as trees, automobiles, and walls.

- Be sure to secure the unit when transporting it.
- Never douse or squirt the unit with water or any other liquid. Clean the unit after each use as described in the cleaning and storage section.

Electrical Safety

1. Ground fault circuit interrupter (GFCI) protection should be provided on the circuit(s) or outlet(s) to be used for this electric blower. Receptacles are available having built-in GFCI protection and may be used for this measure of safety.
2. Make sure that the mains voltage matches that listed on the unit's rating label. Using the improper voltage can damage the motor and injure the user.
3. To prevent electric shock, use only with an extension cord suitable for outdoor use, such as SW-A, SOW-A, STW-A, STOW-A, SJW-A, SJOW-A, SJTW-A, or SJTOW-A.

Before use, check that the extension cord is in good condition. When using an extension cord, make sure to use one heavy enough to carry the current your product will draw. For lengths less than 50 ft (15 m), a No.16 AWG (or greater) extension cord should be used. An undersized cord will cause a drop in line voltage resulting in loss of power and overheating.

WARNING

Electric shock may cause SEVERE INJURY or DEATH. Heed these warnings:

- Do not allow any part of the electric blower to make contact with water while it is in operation. If the appliance becomes wet while turned off, wipe dry before starting.
- Use only a UL-, CSA- or ETL-rated extension cord for outdoor, all-weather use.
- Do not use an extension cord over 100 ft (30 m).
- Do not touch the appliance or its plug with wet hands or while standing in water. Wearing rubber boots offers some protection.

EXTENSION CORD CHART

Extension Cord Length	Up to 50 ft (15 m)	+50 ft - 100 ft (+15 m - 30 m)
Wire Gauge (A.W.G.):	16	14

4. To reduce the risk of electric shock, this appliance has a polarized plug (i.e. one blade is wider than the other). Use this appliance only with a polarized UL-, CSA-, or ETL-listed extension cord recommended for outdoor, all-weather use. The appliance plug will fit into a polarized extension cord only one way. If the appliance plug does not fit fully into the extension cord, reverse the plug. If the plug still does not fit, obtain a correct polarized extension cord. A polarized extension cord will require the use of a polarized wall outlet. The extension cord plug will fit into the polarized wall outlet only one way. If the plug does not fit fully into the wall outlet, reverse the plug. If the plug still does not fit, contact a qualified electrician to install the proper wall outlet. Do not modify the appliance plug, extension cord receptacle, or extension cord plug in any way.
5. To prevent the appliance cord from disconnecting from the extension cord during operation, make a knot with the two cords as shown in Table 1.



DOUBLE-INSULATED: GROUNDING NOT REQUIRED. WHEN SERVICING, USE ONLY IDENTICAL REPLACEMENT PARTS.

This electric blower is double-insulated, eliminating the need for a separate grounding system. Use only identical replacement parts. Read the instructions before servicing double-insulated appliances. Use this blower only as described in this manual.

Table 1. Method of Securing Extension Cord

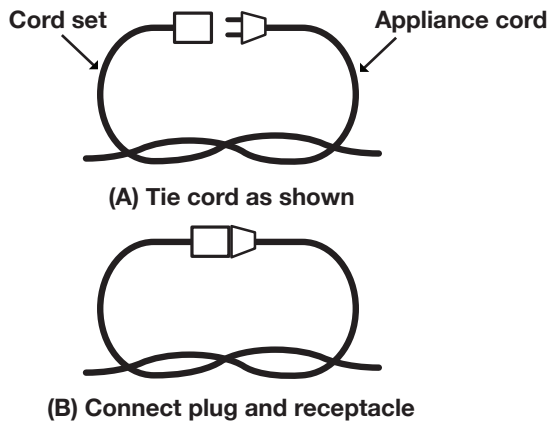











6. Use one of the plug-receptacle retaining straps or connector described in this manual.
7. Do not abuse the cord. Never pull the blower by the cord or yank the cord to disconnect it from the receptacle. Keep the cord away from heat, oil, and sharp edges.

Double-Insulated Appliances

In a double-insulated appliance, two systems of insulation are provided instead of grounding. No grounding means is provided on a double-insulated appliance, nor should a means for grounding be added to the appliance. Servicing a double-insulated appliance requires extreme care and knowledge of the system, and should be performed only by qualified service personnel at an authorized Snow Joe® + Sun Joe® dealer. Replacement parts for a double-insulated appliance must be identical to the parts they replace. A double-insulated appliance is marked with the words “Double Insulation” or “Double Insulated.” The symbol (square within a square) may also be marked on the appliance.

Safety Symbols

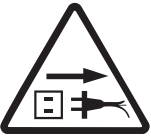
The following table depicts and describes safety symbols that may appear on this product. Read, understand, and follow all instructions on the machine before attempting to assemble and operate.

Symbols	Descriptions	Symbols	Descriptions
	READ THE OPERATOR'S MANUAL(S) – Read, understand, and follow all instructions in the user manual(s) before attempting to assemble and operate.		Keep bystanders and children a safe distance away.
	SAFETY ALERT – Indicates a precaution, a warning, or a danger.		WARNING! Do not expose the unit to rain or wet conditions.
	Beware of flying objects and debris.		Wear hearing protection. Wear eye protection. Wear breathing protection.
	DANGER! Rotating blades pose a serious risk of injury. Keep hands and feet away from openings while the machine is running.		The rotating part will continuously run for several seconds after you turn off the machine.
	Immediately remove the plug from the mains if the power cable is damaged, frayed, or entangled. Always keep the power cable away from heat, oil, and sharp edges.		WARNING! Turn the machine OFF and disconnect it from the power supply before inspecting, cleaning, changing accessories, or conducting any other maintenance task.
	DOUBLE INSULATION – When servicing, use only identical replacement parts.		

Know Your Electric Blower

Read the owner's manual and safety instructions carefully before operating the electric blower. Compare the illustration below to the electric blower in order to familiarize yourself with the location of the various controls and adjustments. Save this manual for future reference.

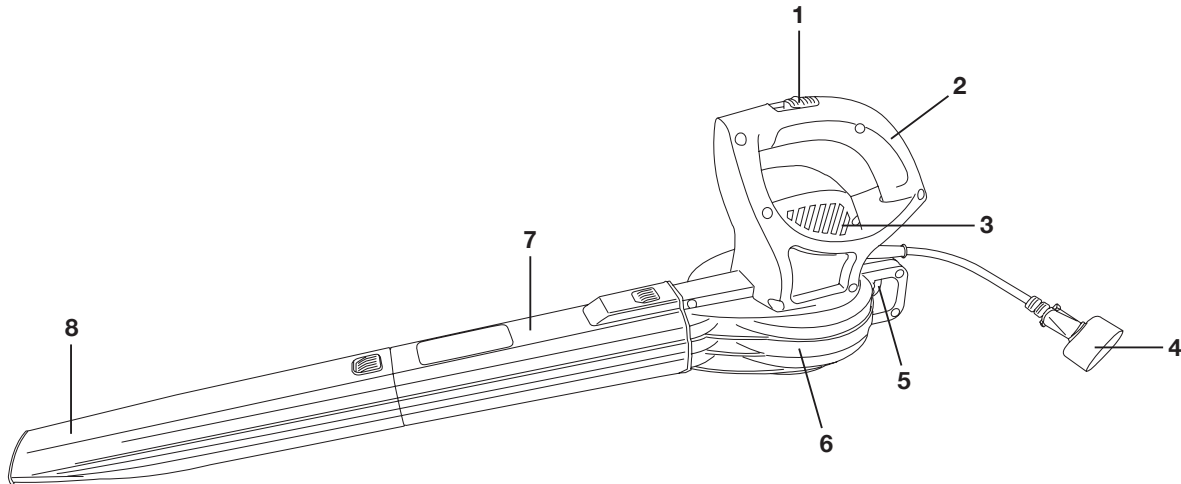

- | | |
|-------------------|----------------------------------|
| 1. ON/OFF switch | 5. Extension cord restraint hook |
| 2. Handle | 6. Blower housing |
| 3. Air vents | 7. Rear blower tube |
| 4. Appliance cord | 8. Front blower tube |

Technical Data

Rated Voltage 120 V ~ 60 Hz
Power 6 A
No Load Speed 14000 rpm

Air Speed Max..... 155 mph (249 km/h)
Air Flow Max..... 260 CFM (7.4 m³/min)
Weight 3.9 lbs (1.75 kg)

Unpacking

Carton Contents

- Electric blower
- Rear blower tube
- Front blower tube
- Manual with registration card

1. Carefully remove the electric blower and check to see that all of the above items are supplied.
2. Inspect the product carefully to make sure no breakage or damage occurred during shipping. If you find damaged or missing parts, DO NOT return the unit to the store. Please call the Snow Joe® + Sun Joe® customer service center at 1-866-SNOWJOE (1-866-766-9563).

NOTE: Do not discard the shipping carton and packaging material until you are ready to use the electric blower. The packaging is made of recyclable materials. Properly dispose of these materials in accordance with local regulations.

IMPORTANT! The equipment and packaging material are not toys. Do not let children play with plastic bags, foils, or small parts. These items can be swallowed and pose a suffocation risk!

Assembly

⚠️ WARNING! To avoid serious personal injury, read and understand all safety instructions provided.

⚠️ WARNING! Do not connect to power supply until assembly is complete. Failure to comply could result in accidental starting and possible serious personal injury.

⚠️ WARNING! Before performing any maintenance, make sure the tool is unplugged from the power supply. Failure to heed this warning could result in serious personal injury.

Attaching the Blower Tube

1. Align the grooves on the front blower tube with the grooves on the rear blower outlet. Push the front blower tube onto the rear blower outlet until it snaps into place (tube is secured by release button) (Figs 1 & 2).

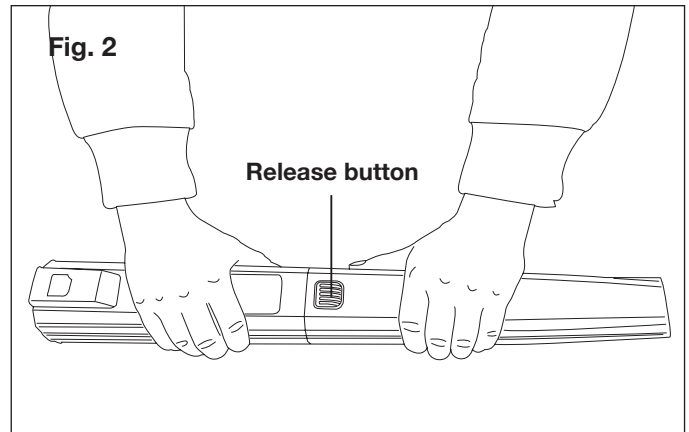
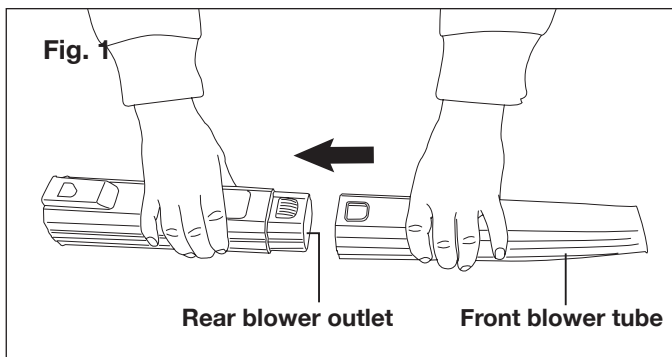

2. Fit the blower tube onto the motor housing (Fig. 3).

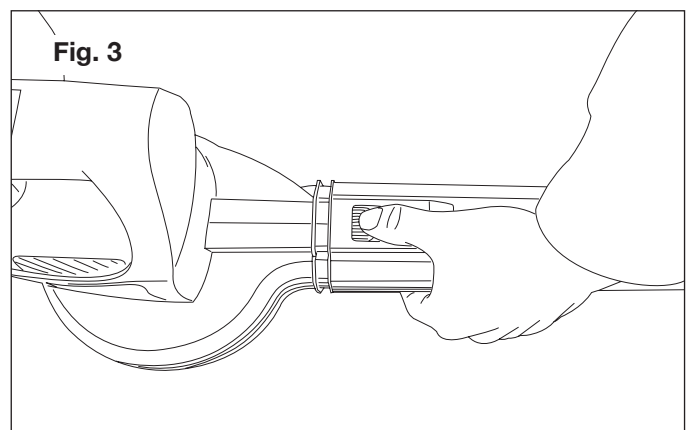

3. Push the blower tube onto the housing and depress the locking button and slide the tube until the lock button sets into hole (Fig. 4).

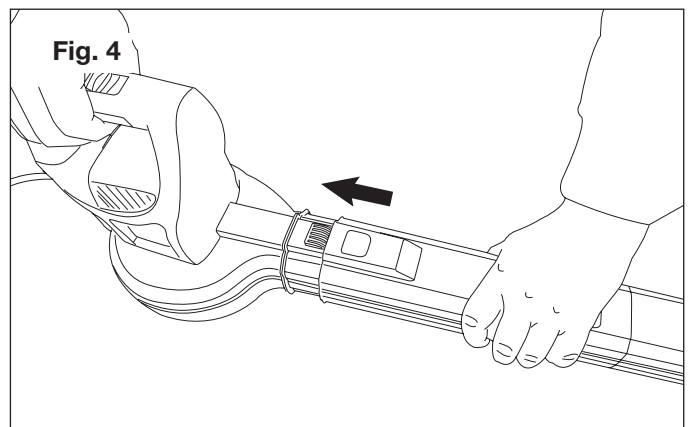

Operation

⚠️ WARNING! Flying debris can cause serious personal injury to the operator, bystanders or pets. Keep bystanders and pets at least 16 ft (5 m) away from the area of work and always wear suitable eye and ear protection, long pants and sturdy shoes or boots while operating the tool.

⚠️ WARNING! Check damaged parts. Before further use of the appliance, a guard or other part that is damaged should be carefully checked to determine that it will operate properly and perform its intended function. Check for alignment of moving parts, binding of moving parts, breakage of parts, mounting, and any other condition that may affect its operation. A guard or other part that is damaged should be properly repaired or replaced by an authorized service center unless indicated elsewhere in this manual.

Connecting to a Power Source

⚠️ WARNING! A damaged extension cord can cause electric shock or a fire. Please inspect the extension cord periodically. The tool must not be used if the cord is damaged in any way. Replace a damaged extension cord before use.

1. Use a heavy duty extension cord, suitable for outdoor use and so marked. An ordinary duty extension cord will cause loss of power and may overheat.
2. Keep the extension cord behind you, away from the area of operation.
3. Secure the extension cord to the motor housing using the cord retainer located at the rear of the blower. Securing the extension cord in this manner prevents accidental removal of the electrical cord during operation (Fig. 5).
4. Plug the female end of the electrical cord into the receptacle at the back of the unit.

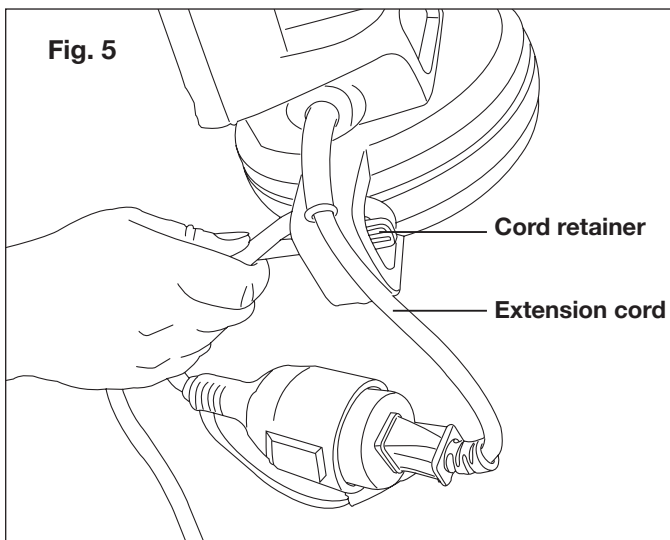

Starting and Stopping

1. To start the electric blower, slide the ON/OFF switch to the (I) position (Figs. 6 & 7).

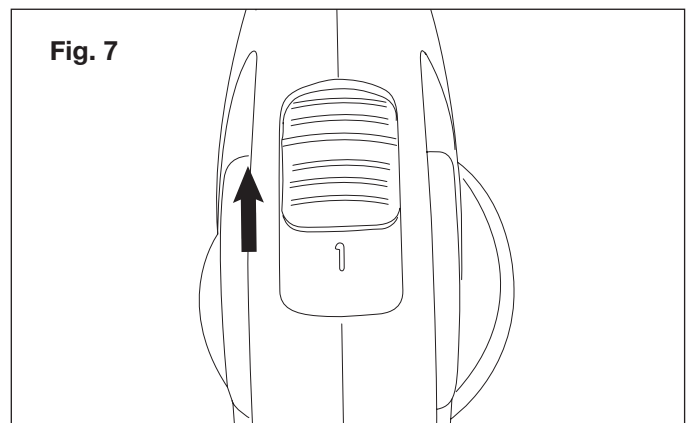
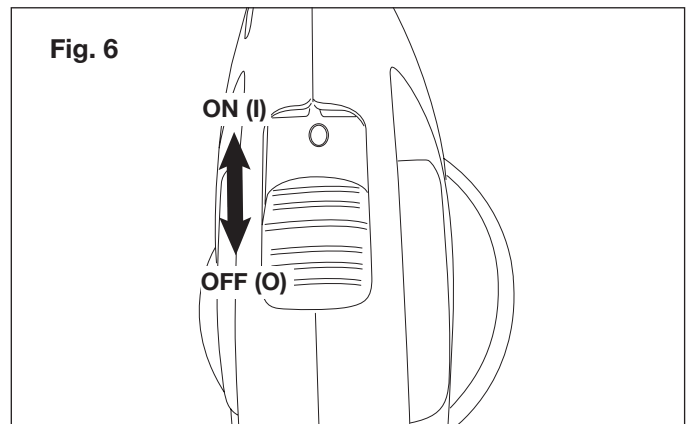

2. To switch off, move the switch to the "0" position (Fig. 8).

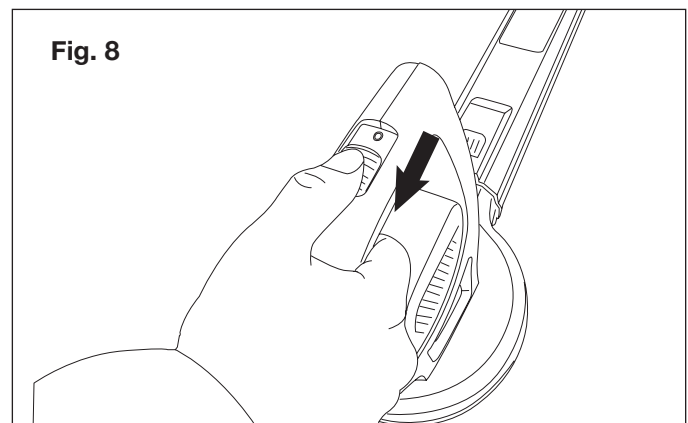

⚠️ WARNING! The tool runs for approximately 5 seconds after it has been switched off. Let the motor come to a complete standstill before setting the tool down.

Blowing Operation

1. Hold the blower at an angle of approximately 45 degrees and sweep from side to side with the nozzle end about 2" to 4" (5 cm to 10 cm) above the ground.
2. Slowly advance keeping the accumulated pile of debris in front of you.
3. If the air flow is too strong, lift the unit a little higher, or blow from a greater distance from the debris.

Maintenance

⚠️ WARNING! Always wear protective gloves during maintenance operations. Do not carry out maintenance when the engine is running or hot.

⚠️ WARNING! Use only original manufacturer's replacement parts, accessories and attachments. Failure to do so can cause possible injury and poor performance.

To order genuine replacement parts or accessories for the Sun Joe® SBJ597E electric blower, please visit snowjoe.com or contact the Snow Joe® + Sun Joe® customer service center at 1-866-SNOWJOE (1-866-766-9563).

⚠️ WARNING! Disconnect the extension cord before performing any maintenance task.

If the extension cord is plugged into the appliance, someone could accidentally turn on the unit while you are inspecting it, which could result in serious personal injury.

1. Store the tool, instruction manual and accessories in a secure, dry place. In this way you will always have the information ready by hand.
2. Keep the tool's air vents unclogged and clean at all times.
3. Remove dust and dirt regularly. Cleaning is best done with a rag or brush.
4. Never use caustic agents to clean plastic parts.

⚠️ WARNING! Do not use cleaning agents to clean the plastic parts of the tool. A mild detergent on a damp cloth is recommended. Water must never come into contact with the tool.

Storage

1. Examine the electric blower thoroughly for worn, loose, or damaged parts. Should you need to repair or replace a part, contact an authorized Snow Joe® + Sun Joe® dealer or call the Snow Joe® + Sun Joe® customer service center at 1-866-SNOWJOE (1-866-766-9563) for assistance.
2. Examine the extension cord thoroughly for signs of excess wear or damage. If it is worn or damaged, replace it immediately.

3. Disconnect the extension cord from the electric blower before storing.
4. Clean the blower tube thoroughly before storing. Store the blower in a dry, well-ventilated place that is inaccessible to children. Keep away from corrosive agents.

Service and Support

If your Sun Joe® SBJ597E electric blower requires service or maintenance, please call the Snow Joe® + Sun Joe® customer service center at 1-866-SNOWJOE (1-866-766-9563).

Model and Serial Numbers

When contacting the company, reordering parts, or arranging service from an authorized dealer, you will need to provide the model and serial numbers, which can be found on the decal located on the housing of the unit. Copy these numbers into the space provided below.

Record the following numbers from the housing or handle of your new product:	
Model #:	
S B J 5 9 7 E	
Serial #:	

Troubleshooting

⚠️ WARNING! Always unplug the power cord before performing any adjustments, maintenance, or repairs to your electric blower.

Problem	Possible Cause	Solution
Motor fails to start when switch is turned on.	<ol style="list-style-type: none"> 1. Power cord is not plugged in or connection is loose. 2. Household circuit breaker is tripped. 	<ol style="list-style-type: none"> 1. Plug in the power cord. 2. Check circuit breaker.

Accessories

⚠️ WARNING! ALWAYS use only authorized Snow Joe® + Sun Joe® replacement parts and accessories. NEVER use replacement parts or accessories that are not intended for use with this electric blower. Contact Snow Joe® + Sun Joe® if you are unsure whether it is safe to use a particular replacement part or accessory with your electric blower. The use of any other attachment or accessory can be dangerous and could cause injury or mechanical damage.

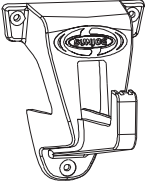
Accessories	Item	Model
<p>1</p> 	<p>Universal wall bracket with mounting hardware</p>	<p>SJWB (Fits most Snow Joe® + Sun Joe® yard and garden tools)</p>

NOTE: Accessories are subject to change without any obligation on the part of Snow Joe® + Sun Joe® to provide notice of such changes. Accessories can be ordered online at snowjoe.com or via phone by contacting the Snow Joe® + Sun Joe® customer service center at 1-866-SNOWJOE (1-866-766-9563).



SNOW JOE® + SUN JOE® CUSTOMER PROMISE

ABOVE ALL ELSE, Snow Joe® + Sun Joe® are dedicated to you, our customer. We strive to make your experience as pleasant as possible. Unfortunately, there are times when a product does not work or breaks under normal operating conditions. We think it's important that you know what you can expect from us. That's why we created the Snow Joe® + Sun Joe® promise.

OUR PROMISE: Snow Joe® + Sun Joe® warrant new products for two years from the date of purchase. If your product does not work, or there's an issue with a specific part, we will fix this by either sending you a free replacement part or by sending you a new or comparable product at no charge. How cool is that! Before you know it, you'll be back in action cutting, sawing, mowing, washing and...?

PRODUCT REGISTRATION:

Snow Joe®, LLC ("Snow Joe® + Sun Joe®") strongly encourages you to register your purchase. You can register online at snowjoe.com/ProductRegistration, or by printing and mailing in a registration card available online from our website, or calling our Customer Service Department at **1-866-SNOWJOE (1-866-766-9563)**, or by e-mailing us at help@snowjoe.com. Failure to register your product purchase will not diminish your warranty rights. However, registering your purchase will allow Snow Joe® + Sun Joe® to better serve you with any of your customer service needs.

WHO CAN SEEK WARRANTY COVERAGE?

This Warranty is extended by Snow Joe® + Sun Joe® to the owner of this Machine (a "Machine" consists of a product powered by a motor) for residential and personal household use only. This Warranty does not apply to products used for commercial, rental or re-sale purposes. Should ownership of this machine change during the 2-year period, please update the Machine's owner information at snowjoe.com/ProductRegistration.

WHAT IS COVERED?

Snow Joe® + Sun Joe® warrants to the owner that if this Machine fails within 2 years from the date of purchase due to a defect in material or workmanship or as a result of normal wear and tear from ordinary household use, Snow Joe® + Sun Joe® will send a replacement part or product, as needed, free of charge and with free shipping to the original purchaser.

If, in Snow Joe® + Sun Joe®'s sole discretion, the failed Machine cannot be repaired with a part, Snow Joe® + Sun Joe® will elect to either (A) send a new Machine at no charge and with free shipping or (B) refund the full purchase price to the owner.

WHAT IS NOT COVERED?

This Warranty does not apply to the Machines that have been used commercially or in non-household applications. This Warranty does not cover cosmetic changes that do not affect performance. This Warranty is only valid if the Machine is used and maintained in accordance with the instructions, warnings and safeguards contained in the owner's manual. Snow Joe® + Sun Joe® will not be responsible for the cost of any unauthorized warranty repairs. This warranty does not cover any cost or expense incurred by the purchaser in providing substitute equipment or service during reasonable periods of malfunction or non-use of this product while waiting for a replacement part or unit under this warranty.

Wearing parts like belts, augers, chains and tines are not covered under this warranty, and can be purchased at snowjoe.com or by calling **1-866-SNOWJOE (1-866-766-9563)**. Batteries are covered in full for 90-days from the date of purchase.

Repair, replacement or refund of the purchase price are the exclusive remedies of purchaser and the sole liability of Snow Joe® + Sun Joe® under this warranty. No employee or representative of Snow Joe® + Sun Joe® is authorized to make any additional warranty or any modification to this warranty which may be binding upon Snow Joe® + Sun Joe®. Accordingly, purchaser should not rely upon any additional statements made by any employee or representative of Snow Joe® + Sun Joe®. In no event, whether based on contract, indemnity, warranty, tort (including negligence), strict liability or otherwise, shall Snow Joe® + Sun Joe® be liable for any special, indirect, incidental, or consequential damages, including, without limitation, loss of profit or revenue.

Some states do not allow limits on warranties. In such states, the above limitations may not apply to you.

Outside the USA, other warranties may apply.



snowjoe.com