



3pt 60" Spike Aerator

OWNER'S MANUAL



WARNING:

Carefully read and understand all **ASSEMBLY AND OPERATION INSTRUCTIONS** before operating. Failure to follow the safety rules and other basic safety precautions may result in serious personal injury.

Model # YTF-60SA3PT

Thank you very much for choosing this product! For future reference, please complete the owner's record below:

Model: _____ Purchase Date: _____

Save the receipt, the warranty, and these instructions. It is important that you read the entire manual to become familiar with this product before you begin using it.

This product is designed for certain applications only. The manufacturer cannot be responsible for issues arising from modification. We strongly recommend that this product not be modified and/or used for any application other than that for which it was designed. If you have any questions relative to a particular application, DO NOT use the product until you have first contacted us to determine if it can, or should, be performed on the product.

For technical questions, please call **1-218-943-6296**.

INTENDED USE

Ideal for aerating your compact soil and lawns, allowing nutrients in and keeping your soil and lawns healthy and performing well.

TECHNICAL SPECIFICATIONS

Item	Description
Category	1
Working Width	60"
Construction	Steel
Dimensions	66.3"x30.55"x32.83"

GENERAL SAFETY RULES



WARNING: Read and understand all instructions. Failure to follow all instructions listed below may result in serious injury.



CAUTION: Do not allow persons to operate or assemble this Spike Aerator until they have read this manual and have developed a thorough understanding of how the Spike Aerator works.



WARNING: The warnings, cautions, and instructions discussed in this instruction manual cannot cover all possible conditions or situations that could occur. It must be understood by the operator that common sense and caution are factors that cannot be built into this product, but must be supplied by the operator.

SAVE THESE INSTRUCTIONS

WORK AREA

- **Keep work area clean**, free of clutter, and well-lit. Cluttered and dark work areas can cause accidents.
- **Keep children and bystanders** away while operating a **Spike Aerator**. Distractions can cause you to lose control, so visitors should remain at a safe distance from the work area.
- **Be alert of your surroundings**. Using a **Spike Aerator** in confined work areas may put you dangerously close to sharp tools and rotating parts.

PERSONAL SAFETY

- **Stay alert**, watch what you are doing, and use common sense when using a **Spike Aerator**. Do not use a **Spike Aerator** while you are tired or under the influence of drugs, alcohol, or medication. A moment of inattention while operating a **Spike Aerator** may result in serious personal injury.
- **Dress properly**. Do not wear loose clothing, dangling objects, or jewelry. Keep your hair, clothing, and gloves away from moving parts. Loose clothes, jewelry, or long hair can be caught in moving parts.
- **Use safety apparel and equipment**. Use safety goggles or safety glasses with side shields that comply with current national standards or, when needed, a face shield. Use a dust mask if working in dusty work conditions. This applies to all persons in the work area. Also use non-skid, safety shoes, hard hats, gloves, dust collection systems, and hearing protection when appropriate.

Spike Aerator USE AND CARE

- **Do not modify the Spike Aerator in any way**. Unauthorized modification may impair the function and/or safety and could affect the life of the equipment. There are specific applications for which the **Spike Aerator** was designed.
- **Always check for damaged or worn-out parts before using the Spike Aerator**. Broken parts will affect the **Spike Aerator's** operation. Replace or repair damaged or worn parts immediately.
- **Do not exceed the Spike Aerator load capacity**.
- **Distribute the load evenly**. Uneven loads may cause the **Spike Aerator** to tip, resulting in personal injury to the operator or others.
- **Use the Spike Aerator on flat and level surfaces** capable of supporting the **Spike Aerator** and its maximum load. Pulling or pushing a load on a slanted or uneven surface can result in loss of control.
- **Store idle Spike Aerator**. When **Spike Aerator** is not in use, store it in a secure place out of the reach of children. Inspect it for good working condition prior to storage and before re-use.

ASSEMBLY INSTRUCTIONS

Step 1: Attach pillow block bearing (#11) to the axle of the spike aerator, then insert gasket (#12) and cotter pin $\text{Ø}5 \times 50$ (#17).

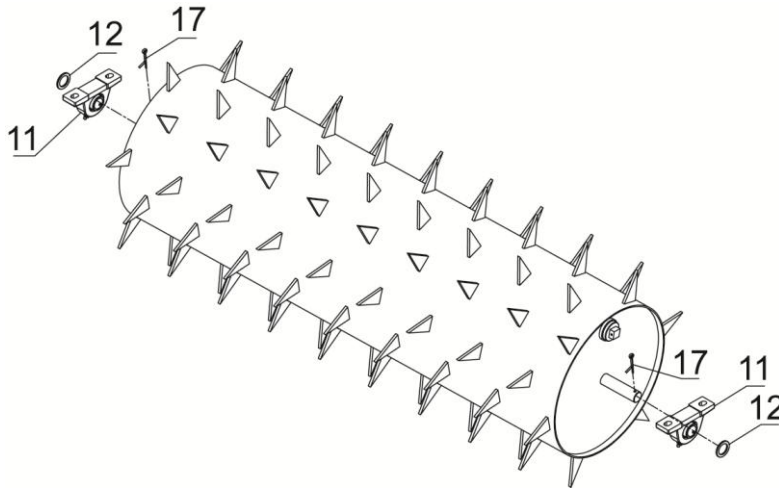

Step 2: Attach frame (#10) to the pillow block bearing (#11) using hex bolt M12x80 (#13), flat washer $\text{Ø}12$ (#6), and nylon lock nut M12 (#7) to tighten, also tight the set screw in the collar make sure the shaft will not loose.

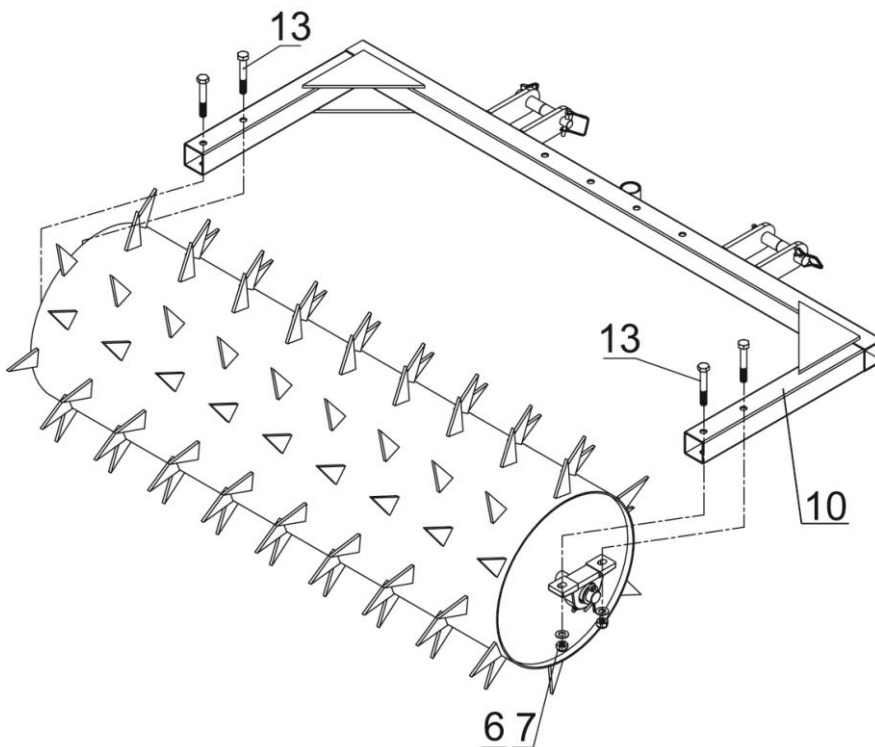

Step 3: Insert drive pin (#3) to the support leg (#14), then insert support leg (#14) to the frame (#10) and tighten with hex bolt M10x45 (#15) and nylon lock nut M10 (#16).

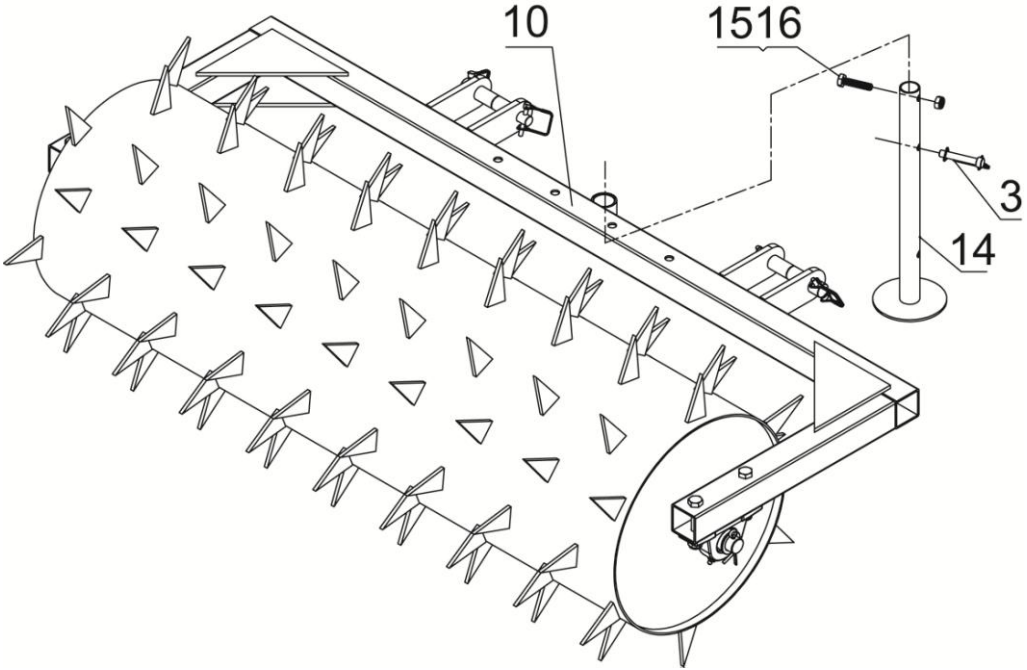

Step 4: Attach 3-point bracket (#5) to the frame (#10) using hex bolt M12x80 (#13), flat washer Ø12 (#6), and nylon lock nut M12 (#7).

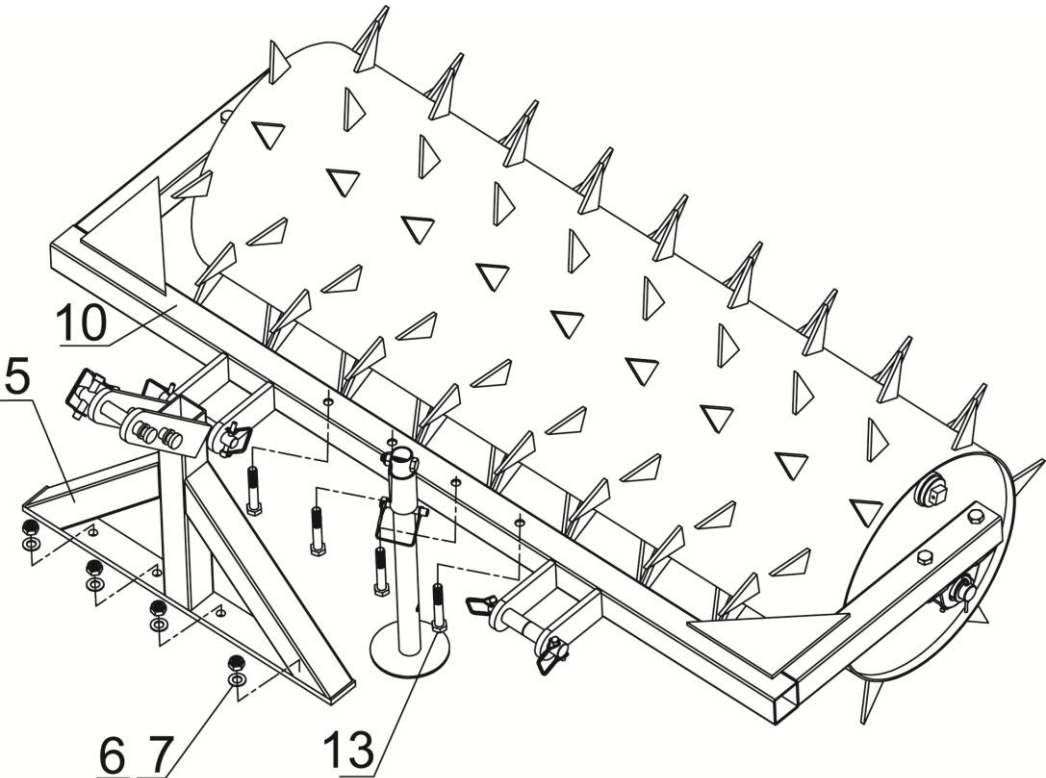

OPERATION

- Connect the aerator to the category 1 tractor. Lift the aerator. Remove the pin (#3) from the support leg (#14), raise the support leg, and insert pin (#3) back in the raised leg during aerator use.

MAINTENANCE

- **Maintain your Spike Aerator.** It is recommended that the general condition of any **Spike Aerator** be examined before it is used. Keep your **Spike Aerator** in good repair by adopting a program of conscientious repair and maintenance. If any abnormal vibrations or noise occurs, have the problem corrected before further use. Have necessary repairs made by qualified service personnel.

PARTS DIAGRAM

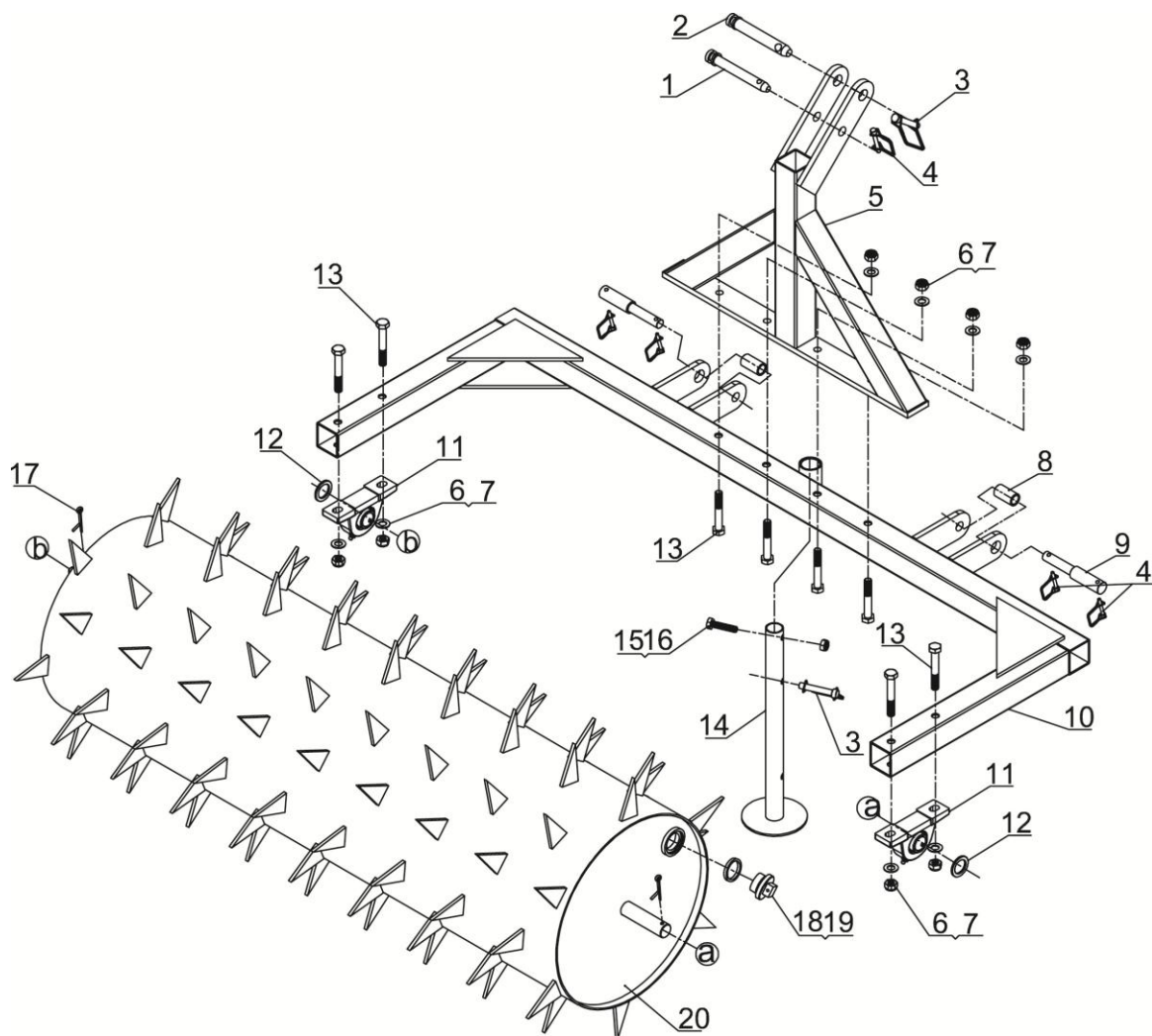

PARTS LIST

Part#	Description	Qty.
1	Hitch Pin Ø16x138	1
2	Hitch Pin II Ø19x138	1
3	Drive Pin Ø9x65	2
4	Drive Pin Ø6x53	5
5	3-Point Bracket	1
6	Flat Washer Ø12	8
7	Nylon Lock Nut M12	8
8	Pin Sleeve	2
9	Pin Ø22x134	2
10	Frame	1
11	Pillow Block Bearing	2
12	Gasket	2
13	Hex Bolt M12x80	8
14	Support Leg	1
15	Hex Bolt M10x45	1
16	Nylon Lock Nut M10	1
17	Cotter Pin Ø5x50	2
18	Thread Plug	1
19	Washer Ø40xØ33x5	1
20	Steel Roller	1

For replacement parts and technical questions, please call **1-218-943-6296**.

WARRANTY

One-year limited parts warranty.



TG
PO BOX 203
Miltona, MN 56354

Made in China