

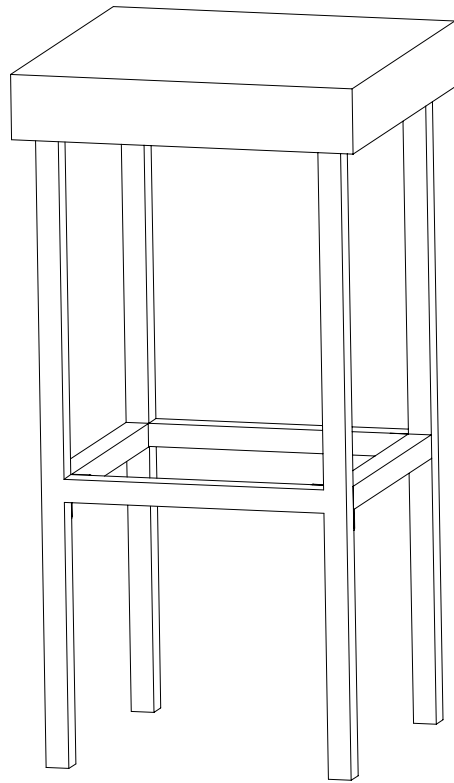



PALM HARBOR OUTDOOR
WICKER 29" BAR STOOL
CO7108-BR

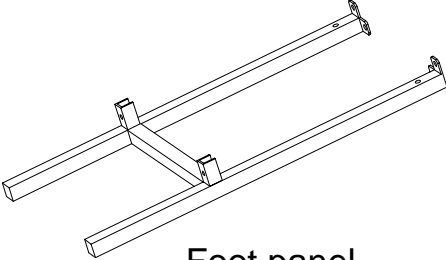
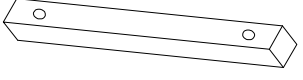

PART LIST

 <p>Seat</p>		 <p>Foot panel</p>		 <p>Stretcher</p>	
A	1pc	B	2pcs	C	2pcs

HARDWARE LIST

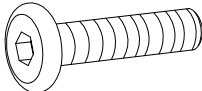
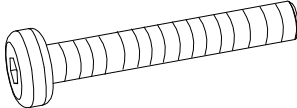
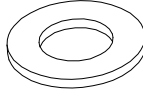
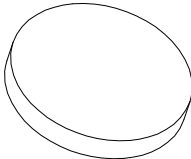
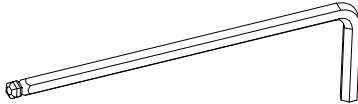
 <p>Bolt(M6*20mm)</p>		 <p>Bolt(M6*40mm)</p>		 <p>Washer(M6mm)</p>	
D	12pcs	E	4pcs	F	16pcs
 <p>Screw cap(M6mm)</p>		 <p>Allen Key(M6mm)</p>			
G	16pcs	H	1pc		

Step 1. Attach foot panels (B) into stretcher (C). Please do not screw at this step.

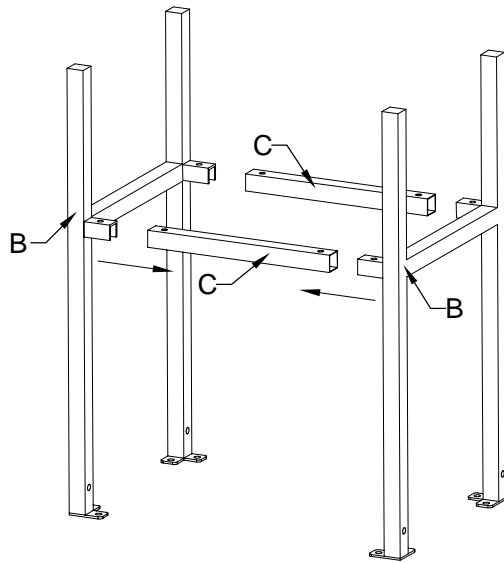

Step 2. Lay seat (A) down on a flat surface. Attach assembled parts B, C to the seat (A) using bolts (D), washers (F), allen key (H) in vertical direction. Cross direction by using bolts (E), washers (F), allen key (H).
NOTE: Do not fully tighten bolt until all bolts are in place.

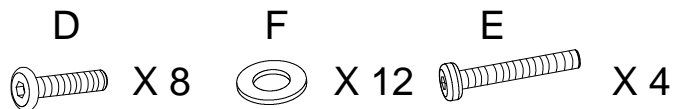
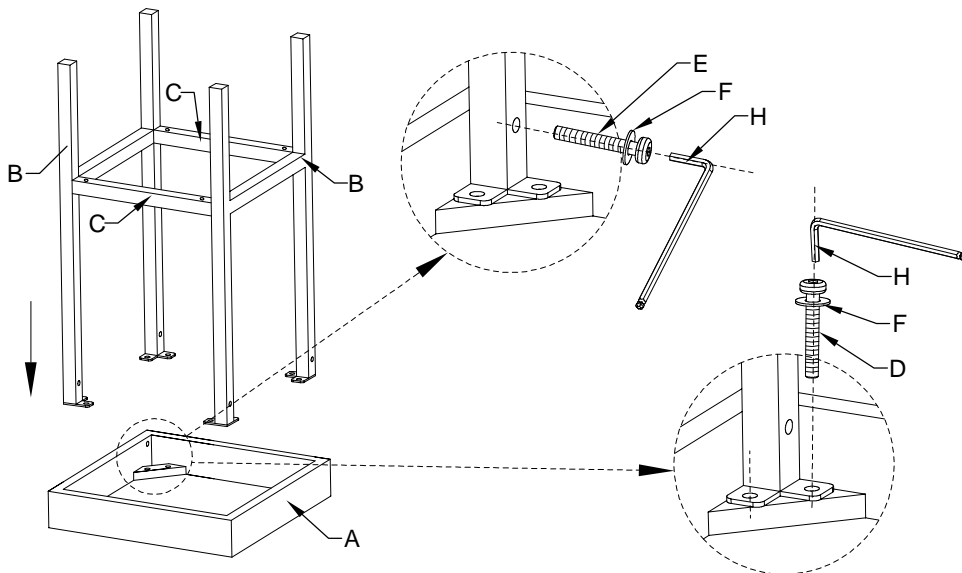

Step 3. Using bolts (D), and washers (F) attach stretchers (C) to foot panels (B).

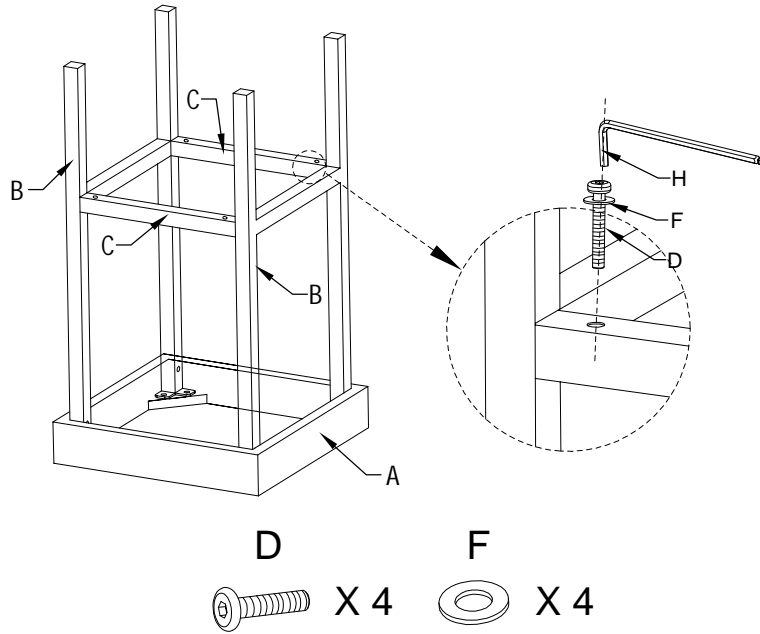

Step 4. Tighten all bolts, and put Caps (G) on the head of bolts.

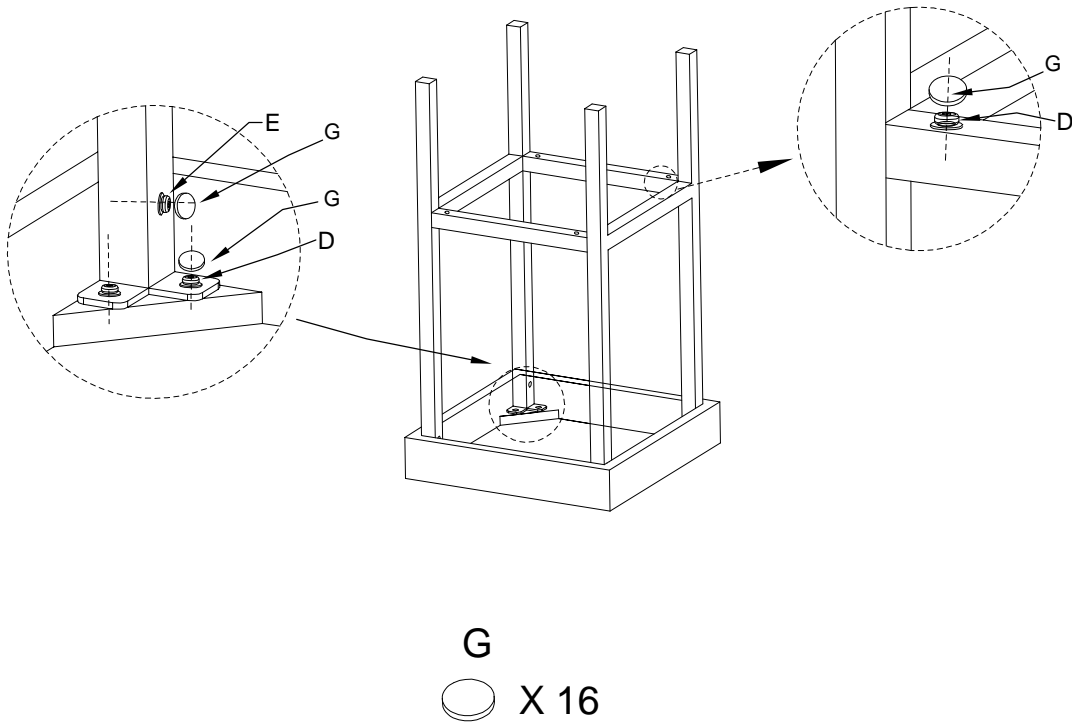

Step 5. Turn the assembled bar stool upright on a flat surface.

