

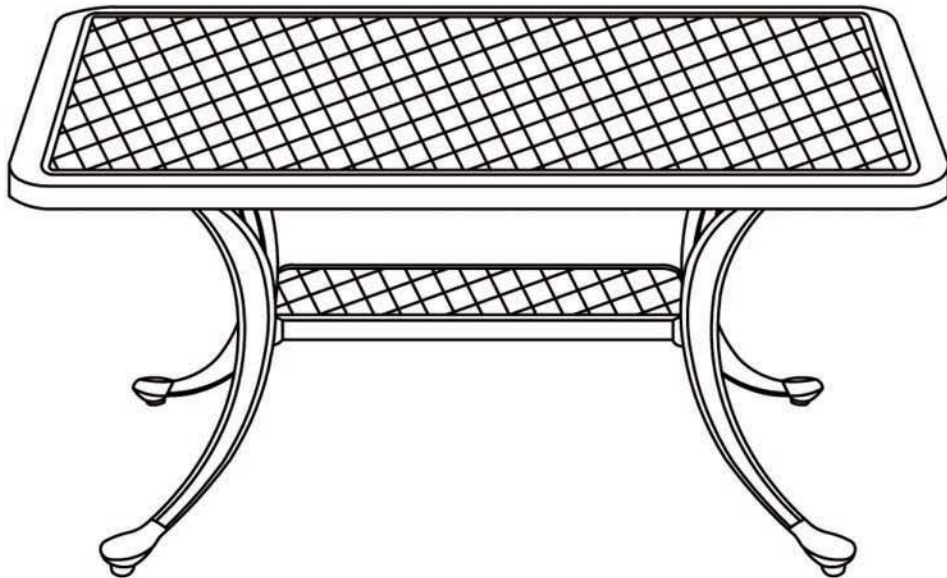







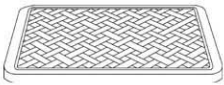
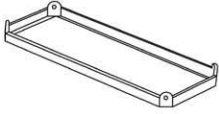

CAST ALUM. RECT COFFEE TABLE
CO6201-BK



PARTS LIST

A 	B 	C 
<p>Leg 4 PCS</p>	<p>Top 1 PC</p>	<p>Stretcher 1 PC</p>

HARDWARE LIST

1 	2 	3 	4 	5 
<p>Cylinder Bolt (M8*35) 4PCS</p>	<p>Spring Washers (M8) 8 pcs.</p>	<p>Flat Washers (M8) 8 pcs.</p>	<p>Nuts (M8) 8 pcs.</p>	<p>Nut Caps (M8) 8 pcs.</p>
6 				
<p>Wrench (M6 &M8) 1 PC</p>				

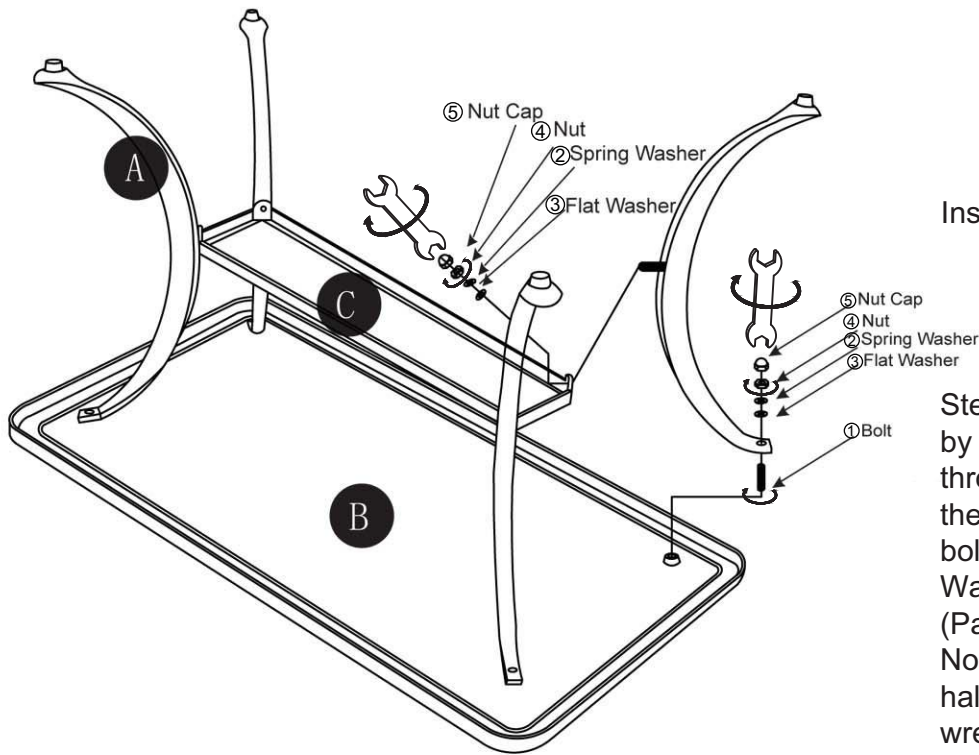

Step 1: Place Top (B) upside down on a soft cloth.





Insert all Cylinder Bolts (Part #1) into the pre-drilled holes of Top (B).

Step 2: Attach two adjacent Legs (B) by inserting the Cylinder Bolts (Part #1) through the holes in Legs (A) by fitting the leg on top of the attached cylinder bolt. Secure the Legs (B) using Flat Washers (Part #3), Spring Washers (Part #2), and Nuts (Part #4). Note - -Tighten the Nuts (Part #4) only half way at this time using wrench (Part #6).

Step 3: Attach Stretcher (C) to the two attached Legs (A) with Flat Washers (Part #3), Spring Washers (Part #2), and Nuts (Part #4). Note - -Tighten the Nuts (Part #4) only half way at this time.

Attach the other two legs (B) to the Top (B) & Stretcher (C) using the same method as the first two legs. Tighten all Nuts (Part #4) completely.

Step 4: Cover all Nuts (Part #4) with Nut Caps (Part #5). Turn the table over to the upright position. Adjust the levelers on the bottom of the legs to level the table.

- | | | |
|-----------------|---|-----|
| ① Bolt |  | x 4 |
| ② Spring Washer |  | x 8 |
| ③ Flat Washer |  | x 8 |
| ④ Nut |  | x 8 |
| ⑤ Nut Cap |  | x 8 |

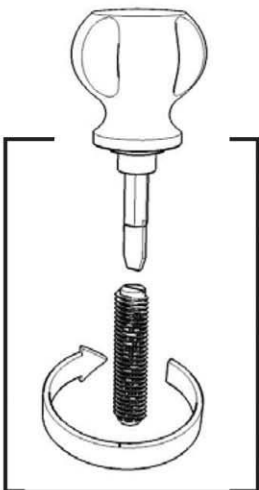

Figure 1
Flathead screw driver (not included)

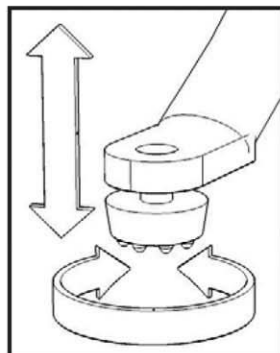

Figure 2