

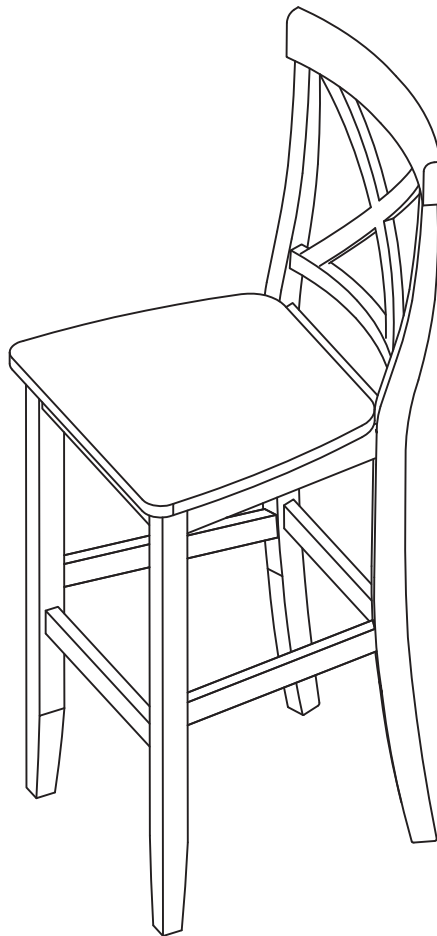

X-Back Bar Stool





CF500424/500430









ASSEMBLY INSTRUCTIONS

ITEM#: CF500424/500430

DESCRIPTION: 24 "/30" X-Back Bar Stool

Part Lists			
No.	Description	Sketch	Q'ty
A	BACK FRAME		1 PC
B	SEAT FRAME		1 PC
C	FRONT LEG (RIGHT AND LEFT)		1 PAIR
D	SIDE STRETCHER (RIGHT AND LEFT)		1 PAIR
E	FRONT STRETCHER		1 PC

Hardware Lists			
No.	Description	Sketch	Q'ty
a	LONG BOLT (5/16 x 80")		4 PCS
b	BOLT (5/16 x 60")		4 PCS
c	SHORT BOLT (5/16 x 40")		3 PCS
d	SPRING WASHER		11 PCS
e	FLAT WASHER		11 PCS
f	ALLEN WRENCH		1 PC
g	SCREW(#8X1-1/2")		6 PCS

Step 1

Attach seat frame (B) to the back frame (A) using long bolts (a), short bolts (c), spring washers (d), and flat washers (e) as shown in Figure 1. Three short bolts (c) will be used in the center of the seat frame. The four long bolts (a) will be used on the back corners of the seat frame.

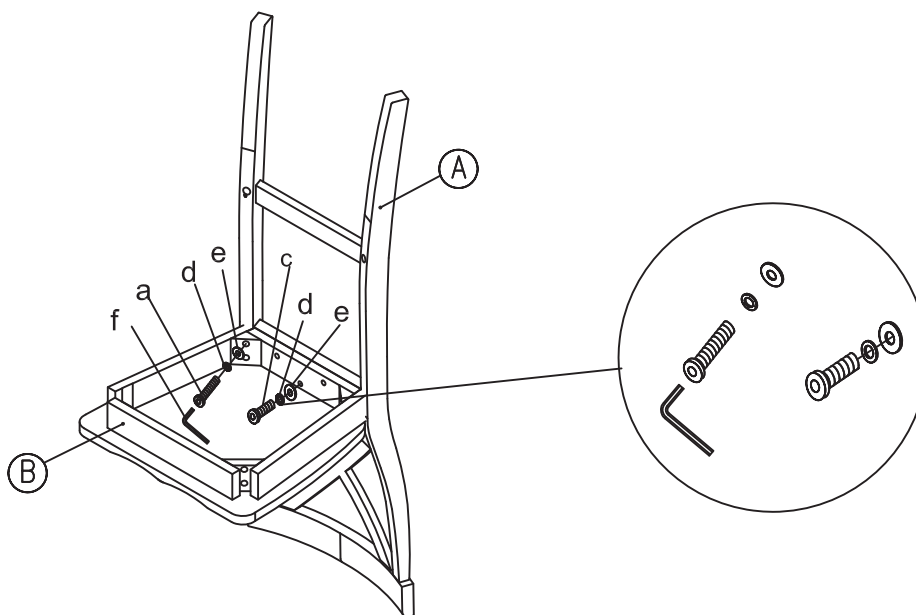

Step 2

Attach left and right front legs (C) to the seat frame (B) using the bolts (b), spring washers (d) and flat washers (e) as shown in Figure 2. **Do not tighten bolts at this time.**

Note: The left and right front legs (C) are marked "R" & "L".

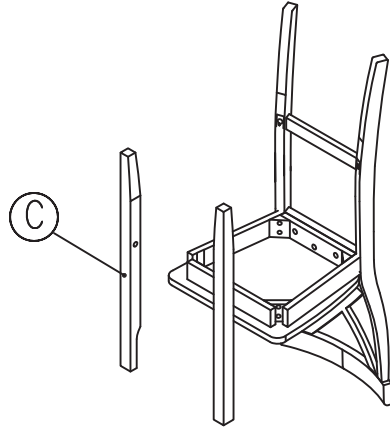

Step 3

Insert the left and right side stretchers (D) into the back frame legs (A) and the front legs (C). Insert the front stretcher (E) into the front legs (C) as shown in Figure 3.

Note: If you have trouble inserting the stretchers, loosen the bolts (b) slightly to allow for extra space. The side stretchers (D) are marked "R" & "L".

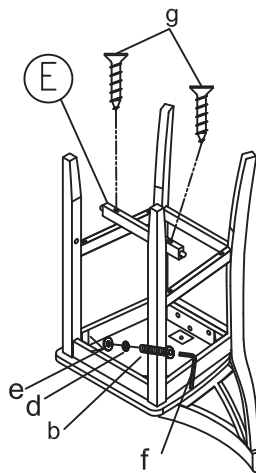

Step 4

Ensure that the side stretchers (D) are flush with back frame (A) and front legs (C). Secure with screws (g) using Phillips head screw driver. Repeat this step, securing the front stretcher (E) to the front legs (C). Finger-tighten the bolts (b).

Step 5

Turn stool upright on its legs and place on a flat, level floor. Make sure that the stool is level and square. Tighten all bolts (a, b and c) completely with supplied Allen wrench (f).