



*X-TALKER* with ClearBand™ Technology



## GMRS TWO-WAY RADIOS



T70 Series

[midlandusa.com](http://midlandusa.com)

## Welcome to the world of Midland electronics

Congratulations on the purchase of your high quality MIDLAND product. Your two-way radio represents state-of-the-art high-tech engineering and is designed for GMRS (General Mobile Radio Service) operation. It is a quality piece of electronic equipment, skillfully constructed with the finest components. The circuitry is all solid-state and mounted on a rugged printed circuit board. Your two-way radio is designed for reliable and trouble-free performance for years to come.

### Features

- 36 GMRS/FRS Channels
- 121 Privacy Codes (38 CTCSS / 83 DCS)
- VOX
- 5 Selectable Call Alerts (5 additional Animal Sounds on T75)
- Vibrate Alert (T75 only)
- NOAA Weather Scan
- NOAA Weather Radio
- NOAA Weather Alert
- Scan Function
- Monitor Function
- Roger Beep Tone
- Silent Operation
- Key Pad Lock
- Power High / Low Settings
- Speaker / Microphone Jacks
- Battery Meter / Battery Low Indicator
- USB Jack Charging

This device complies with Part 15 of the FCC Rules. Operation is subject to the following two conditions: (1) this device does not cause harmful interference, and (2) this radio must accept any interference that may cause undesired operation.

To maintain compliance with FCC's RF exposure guidelines, for body-worn operation, this radio has been tested and meets the FCC RF exposure guidelines when used with Midland Radio Corp. accessories supplied or designated for this product. Use of other accessories may not ensure compliance with FCC RF exposure guidelines.

**IMPORTANT NOTICE, FCC LICENSE REQUIRED FOR GMRS OPERATION  
(Only Applicable for GMRS Radio Use in the United States)**

The radios operate on GMRS (General Mobile Radio Service) frequencies which require an FCC (Federal Communications Commission) license. You must be licensed prior to operating on channels 1 - 7 or 15 - 22, which comprise the GMRS channels of the radios. Serious penalties could result from unlicensed use of GMRS channels, in violation of FCC rules, as stipulated in the Communications Acts Sections 501 and 502 (amended).

You will be issued a call sign by the FCC which should be used for station identification when operating the radio on GMRS channels. You should also cooperate by engaging in permissible transmissions only, avoiding channel interference with other GMRS users, and being prudent with the length of your transmission time.

To obtain a license or ask questions about the license application, contact the FCC at 1-888-CALL FCC or go to the FCC's website:

<http://www.fcc.gov> and request form **605**.

**Exposure To Radio Frequency Energy**

Your Midland radio is designed to comply with the following national and international standards and guidelines regarding exposure of human beings to radio frequency electromagnetic energy:

- United States Federal Communications Commission, Code of Federal Regulations: 47 CFR part 2 sub-part J
- American National Standards Institute (ANSI)/Institute of Electrical & Electronic Engineers (IEEE) C95. 1-1992
- Institute of Electrical and Electronic Engineers (IEEE) C95. 1-1999 Edition
- National Council on Radiation Protection and Measurements (NCRP) of the United States, Report 86, 1986
- International Commission on Non-Ionizing Radiation Protection (ICNIRP) 1998

To control your exposure and ensure compliance with the general population or uncontrolled environment exposure limits, transmit no more than 50% of the time. The radio generates measurable RF energy exposure only when transmitting.

**IMPORTANT:** Changes or modifications to this unit not expressly approved by **MIDLAND RADIO CORP.** could void your right to operate this unit. Your radio is set up to transmit a regulated signal on an assigned frequency. It is against the law to alter or adjust the settings inside the **COMMUNICATOR** to exceed those limitations. Any adjustment to your radio must be made by qualified technicians.

## LCD DISPLAY

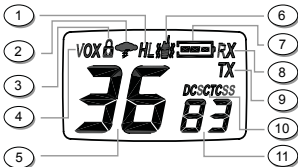

## CONTROLS

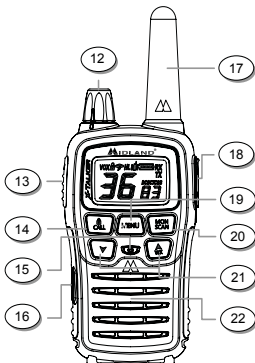

- 1. TRANSMIT POWER LEVEL ICON** – Indicates TX Power setting (H/L).
- 2. NOAA WEATHER (WX) BAND ICON** – Indicates when the radio is in Weather Band mode.
- 3. KEY LOCK ICON** – Indicates KEY LOCK mode is on.
- 4. VOX ICON** – Indicates when VOX mode is active.
- 5. CHANNEL NUMBER** – Changes from 1~36 on GMRS/FRS band (1~10 on WX band).
- 6. VIBRATE ALERT ICON** – Indicates when the Vibrate-Alert feature is on (Model T75 only).
- 7. BATTERY METER** – Indicates the battery level.
- 8. RECEIVE (RX) ICON** – Indicates radio is receiving a transmission.
- 9. TRANSMIT (TX) ICON** – Indicates radio is transmitting a signal.
- 10. PRIVACY CODE ICON** – Indicates Privacy Code setting (CTCSS/DCS).
- 11. PRIVACY CODE** – Indicates Privacy Code selected by user (oF~38/oF~83). It can only be set in Ch 1~22.
- 12. POWER/VOLUME KNOB** – Turn clockwise to turn the power on and increase the volume level. Turn counter-clockwise to decrease the volume level and turn the power off.
- 13. PTT Button** – Press and hold to transmit voice communication.
- 14. CALL/LOCK Button** – Press to send a CALL ALERT signal. Press and hold to turn KEY LOCK on/off.
- 15. MIC** – Built-in microphone.
- 16. USB CHARGING JACK**
- 17. ANTENNA**
- 18. EXTERNAL SPEAKER/MIC JACK**
- 19. MENU Button** – Press momentarily to access Menu mode.
- 20. MONITOR/SCAN Button** – Press to enter SCAN mode. Press and hold to enter MONITOR mode.
- 21. UP/WX SCAN ▲ and DOWN ▼ Buttons** – Make adjustments in MENU mode. Press and hold the UP button for 5 seconds to activate the NOAA Weather Scan function.
- 22. SPEAKER** – Built-in speaker.

## BATTERY INSTALLATION

Your radio operates with either a NiMH battery pack or optional 3 AA alkaline batteries. The belt clip should be removed (see below) to ease installation or removal of the batteries.

To install the batteries:

1. With the back of the radio facing you, remove the belt clip (see diagram below) for easy access, then remove the Battery Cover by pressing down on the top center and sliding it down from the radio.
2. Insert NiMH battery pack or 3 AA batteries observing the polarity as shown. Installing the batteries incorrectly will prevent the unit from operating or may damage the unit.
3. Return the Battery Cover by sliding it up on the radio. Replace the belt clip, making sure it locks into place.

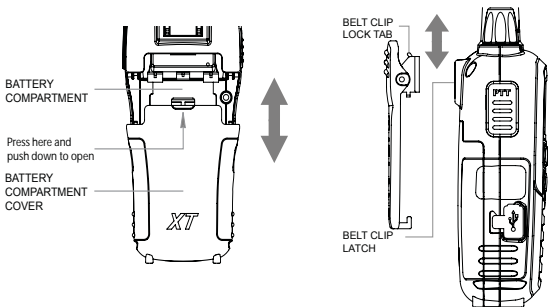

## INSTALLING THE BELT CLIP

To install the **BELT CLIP**, slide the clip down into the slot on the back of the radio until the **BELT CLIP LATCH** clicks. To remove the **BELT CLIP**, pull the **LOCK TAB** away from the radio, then gently pull the belt clip up toward the top of the radio.

## **CHARGING THE BATTERY PACK**

Your radios are equipped for using a rechargeable NiMH battery pack (BATT10) which can be recharged by inserting one end of the USB Cable into a USB power source, and the other end into the radio USB charging jack, or with the optional desktop charger (as described below). While charging, the Battery Meter will flash from 1 to 3 bars. The LCD display will show **FULL** when charging is complete. For maximum battery life, Midland recommends charging the battery pack when the low battery icon comes on. Remove the radios from the charger when the charging is finished.

### **To charge using the Desktop Charger:**



1. Place the BATT10 rechargeable battery packs in the radios.
2. Connect one end of the USB Cable into a USB power source.
3. Insert the other end of the USB Cable into the desktop charger USB jack.
4. Place the radios into the desktop charger slot. While charging, the Battery Meter will flash from 1 to 3 bars, and stop when charging is finished. The LCD display will show **FULL**.

***In order to ensure that the battery pack is fully charged, it is recommended that the battery pack be charged with the radio turned OFF.***



1. Only use the Midland NiMH battery pack.
2. Do not attempt to charge alkaline batteries or any batteries or battery packs other than the one indicated in the manual. This may cause leakage and damage to the radio.
3. For long term storage of the radio, turn the radio OFF and remove the batteries from the radio.

## **BATTERY LEVEL INDICATOR**

Your radio has a **BATTERY LEVEL METER**  that shows the battery power level. The greater the number of bars visible, the stronger the battery level. When the battery level is low, the **Battery Shell**  icon and “**bt Lo**” will flash in the display indicating your batteries should be replaced or recharged if using a rechargeable battery pack.

## OPERATING YOUR RADIO

### POWER ON/OFF AND VOLUME

Rotate the **POWER/VOLUME** knob clockwise to turn the radio on and increase the volume level. Rotate the control counter-clockwise to reduce the volume level and to turn the radio off. During Power On, the radio will beep 2 times with different tones, the LCD will display all icons for 1 second and the LCD display will indicate the last channel selected.

### RESTORING YOUR RADIO TO THE ORIGINAL SETTING

To reset your radio to the original (default) setting, turn on the radio while pressing and holding the ▲ button. The LCD display will briefly show the firmware version number and then reset to standby mode on channel 1 with no Privacy Code.

### TRANSMITTING AND RECEIVING A CALL

To communicate, all radios in your group must be set to the same channel and/or Privacy Code.

1. For maximum clarity, hold the radio 2 to 3 inches from your mouth.
2. Press and hold the **PTT** button and speak in a normal voice into the **microphone**. The **TX** icon will appear continuously on the LCD display while transmitting.
3. To receive a call, release the **PTT** button. The **RX** icon will appear on the display when your radio is receiving a transmission.

### ABOUT RANGE

Your radios are designed to give you maximum range under optimum conditions.

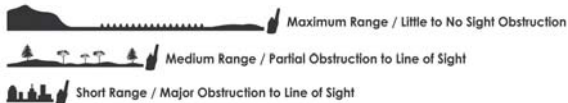

Optimum Conditions are:

- Over water
- Open rural areas without obstructions
- Flat areas where you can see the other person

To ensure you get maximum range:

- Be sure to use fresh or fully charged batteries - low batteries will cause low power conditions.
- Be sure you are on a GMRS channel - FRS channels are restricted by the FCC to low power.
- Be sure to set your radio to use Hi power.

## T70 SERIES QUICK REFERENCE CHART

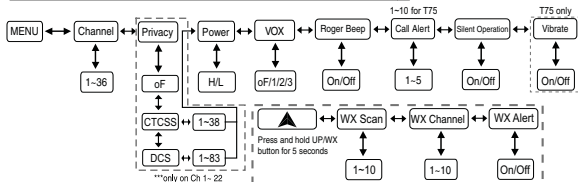

## MONITOR

Pressing and holding the **MONITOR** button for 3 seconds will let you hear noise so you can adjust the volume level of the radio when not receiving a signal. This could also be used to check any activity on your current channel before transmitting.

Press and hold the **MONITOR** button for 3 seconds again to get out of **MONITOR** mode.

## SCAN

Your radio can scan all 36 channels for activity. To enter, quickly press the **SCAN** button. Repeat the same procedure to exit. Your radio will rapidly scan each of the 36 channels and stop on any active channel for 6 seconds before resuming scan.

When you press the **PTT** button to transmit on an active channel, the scanning function will stop and remain on the active channel. To resume scanning, quickly press the **SCAN** button.



## CALL ALERT

Your radio can transmit a call alert. To send a call alert, press the **CALL** button. The **TX** icon will appear while transmitting a call alert and a tone can be heard on the speaker for confirmation. The T71 radio has 5 call alert selections while the T75 has 10 call alerts including 5 “*animal sound*” call alerts - **Cougar, Duck, Crow, Wolf,** and **Turkey**.

## KEYPAD LOCK

To avoid accidentally changing the radio setting, press the **LOCK** button for 4 seconds. The  icon will appear on the display. **PTT** and **CALL** will still be active. Repeat the same procedure to unlock the keypad.

## CHANNEL SELECTION (GMRS/FRS BAND)

Press the **MENU** button once, and then the **▲\▼** buttons to select one of the 36 GMRS/FRS channels. To confirm the selection, press the **PTT** button or press the **MENU** button again to move to the next feature setting.

## SETTING PRIVACY CODES

Your radio has 121 **Privacy Codes** available. The selected **Privacy Code** may be different for each channel. To select a **Privacy Code** for the current channel press the **MENU** button twice, and then the **▲\▼** buttons to select between **Off/CTCSS/DCS**. Press the **MENU** button again and the **▲\▼** buttons to select one of the 38 **CTCSS Codes** or one of the 83 **DCS Codes**. The **Privacy Code** icon on the display will indicate whether you set your Privacy Code in **CTCSS** or **DCS** mode. To confirm the selection, press the **PTT** button or press the **MENU** button again to move to the next feature setting.

**Note** : If you select a **CTCSS** Privacy Code, any pre-selected **DCS** Privacy Code will be cancelled and vice-versa.

Selecting a Privacy Code of “**oF**” will disable the Privacy feature. To communicate between two radios, all radios in your group must be set to the same channel and/or Privacy Code selections.

**The Privacy Code can only be set in channels 1~22.**

## TRANSMIT (TX) POWER LEVEL SELECTION

Your radio has 2 power level settings. To select the power level on channels 1~7 and 15~36, press the **MENU** button until a “Pr” icon will appear blinking on the display. Then press the ▲\▼ buttons to select **TRANSMIT POWER LEVEL** icon (H: Hi/L: Lo). To confirm, press the **PTT** button or press the **MENU** button again to move to the next feature setting. **When the PTT button is pressed during Lo Battery Level condition, the TX Power will automatically switch from Hi(H) to Lo(L) level.**

**Note :** *You cannot adjust the power setting on the FRS channels (8~14). They are set to Lo power per FCC regulations.*

## VOX

Your radio has 9 VOX level settings: (oF/1~9).

To set **VOX**, press the **MENU** button until the display shows “**VOX**”. On the right of the **CHANNEL NUMBER** display, an “oF” icon appears. Select “1” ~ “9” by pressing the ▲\▼ buttons and push the **PTT** key, or press the **MENU** button again to move to the next feature setting. **VOX** will be more sensitive on the lower setting than on the higher setting.

To turn **VOX** off, press the **MENU** button until the display shows “**VOX**”. On the right of the **CHANNEL NUMBER** display, a “1” ~ “9” icon appears. Select “oF” by pressing the ▲\▼ buttons and push the **PTT** key, or press the **MENU** button again to move to the next feature setting.

## ROGER BEEP (end of transmission) TONE

When the **PTT** button is released, the radio will beep to confirm to other users that your transmission has finished.

To set the **ROGER BEEP** tone, press the **MENU** button until the display shows an “rb” icon. Select “on” or “oF” by pressing the ▲\▼ buttons and push the **PTT** key, or press the **MENU** button to move to the next feature setting.

## CALL ALERT SELECTION

Your radio has 5 selectable **CALL ALERTS** (10 for **T75**). To select, press the **MENU** button until a “**CA**” icon appears and to the right of the “**CA**” icon the current **CALL ALERT** setting is displayed. Then press the ▲\▼ buttons to make the **CALL ALERT** selections, and the radio will emit a corresponding tone for each selection. To confirm, press the **PTT** button or press the **MENU** button to move to the next feature setting.

## VIBRATE ALERT (MODEL T75 only)

To set the **VIBRATE ALERT**, press the **MENU** button until the display shows the 📱 icon. Select “**on**” or “**oF**” by pressing the ▲\▼ buttons and push the **PTT** button, or press the **MENU** button. The 📱 icon will remain on the display if set to “**on**”.

## SILENT OPERATION

Your radio has a **SILENT OPERATION** mode. In this mode, all “beeps” and “tones” are disabled.

*To set the **SILENT OPERATION***, press the **MENU** button until the display shows a “**BP**” icon. Select “**on**” or “**oF**” by pressing the ▲\▼ buttons and push the **PTT** key or **MENU** button.

## NOAA WEATHER RADIO/SCAN

Your radio has a **NOAA WEATHER RADIO** function to enable the user to receive weather reports from designated **NOAA** stations.

Your radio also has a **NOAA WEATHER SCAN** function to enable the user to scan all 10 channels of the **NOAA WEATHER RADIO**. To turn the **NOAA WEATHER SCAN** on, press and hold the **WX/▲** button for 5 seconds while in **GMRS** mode. The radio will go to **WX Band** mode and start scanning all 10 channels and stop on any active channel. When the channel becomes inactive for 10 seconds the radio will resume scanning.

To stop the **NOAA WEATHER (WX) SCAN** and set the channel manually on the **WX Band**, press the **MENU** button during **NOAA WEATHER (WX) SCAN**. The radio will stop scanning and the display will show the current **WX Band** channel setting. While on **WX Band** mode press the ▲\▼ buttons to select one of the 10 **NOAA WEATHER (WX) BAND** channels.



To confirm, press the **PTT** button or press the **MENU** button to move to the next feature setting.

To turn the **NOAA WEATHER RADIO** off, press the **PTT** button. The current **GMRS/FRS** radio setting will be displayed and the  icon will go off.

## **NOAA WEATHER ALERT**

Your radio has a **NOAA WEATHER ALERT** function, to enable you to automatically receive weather alerts from designated **NOAA** stations.

*The **NOAA WEATHER (WX) ALERT** is automatically on during **NOAA WEATHER SCAN** mode.*

To turn the **NOAA WEATHER (WX) ALERT** on during normal **NOAA WEATHER RADIO** mode, press the **MENU** button twice while in **NOAA WEATHER SCAN** mode. The display shows "**AL**," while on the right an "**oF**" icon appears. Select "**on**" by pressing the  buttons. To confirm, press the **PTT** button or press **MENU**. The radio will return to **WX BAND** and the  icon will blink. If the radio receives a **WX ALERT** signal from a designated **NOAA** station while on **GMRS/FRS Radio** mode, the radio will beep for 20 seconds while an "**AL**" and "**In**" icon will appear on the display, after which it will automatically go to **WX BAND**.

If any button is pressed during beeping while on **GMRS/FRS Radio** mode, the radio will automatically go to **WX BAND**.

To turn the **NOAA WEATHER (WX) ALERT** off, press the **MENU** button twice while in **WX Band**. The display shows "**AL**," while on the right an "**on**" icon appears. Select "**oF**" by pressing the  buttons. To confirm, press the **PTT** button or press **MENU**.



**Note : The WX Alert is automatically ON during WX SCAN mode.**

## **EXTERNAL SPEAKER/MICROPHONE JACK**

Your radio can be used with an optional external speaker/microphone or headset, freeing your hands for other tasks. To use an optional speaker/microphone or headset:

- Insert the plug(s) into the **SPK/MIC** jacks.
- Place the earbud into your ear, and adjust the mic into your desired position.

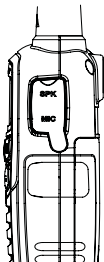

## TROUBLESHOOTING GUIDE

| <b>PROBLEM</b>                            | <b>SOLUTION</b>  |
|---|--|
| No Power                                  | - Check battery installation and/or replace batteries.   |
| Cannot Receive Messages                   | - Confirm the radios have the same channel settings.<br>- Make sure that you are within range of the other transceivers.<br>- Buildings and other structures may interfere with your communication.              |
| Radio is not responding to button presses | - Make sure key lock is not on ( <i>See Keypad Lock, Page 9</i> ).<br>- Radio might need to be reset. Turn radio off then on.  |
| Display is dim                            | - Recharge or replace batteries.   |
| Charger not functioning                   | - Contacts on the bottom of the radio may require cleaning.<br>- Ensure the outlet where the charger is plugged in is functioning properly.<br>- Check that the battery pack is installed in the radio properly. |

## USE AND CARE

1. Use a soft damp cloth to clean the radio.
2. **Do not** use alcohol or cleaning solutions to clean the radio.
3. **Do not** immerse the radio in water.
4. Dry the radio with a dry lint-free cloth should it get wet.
5. Turn off the radio and remove the batteries during long-term storage.

If you have a problem which you believe requires service, please call first and speak with a service technician at 816-241-8500. Many problems can be remedied over the phone without returning the unit for service.

## SPECIFICATIONS

- Channels** 36 GMRS/FRS Channels +121 Privacy Codes  
10 NOAA Weather (WX) Band Channels
- Operating Frequency** UHF 462.5500 ~ 467.7125 MHz
- Power Source** 3 AA Alkaline or 3.6V Rechargeable NiMH battery pack

### GMRS/FRS FREQUENCY CHART (MHz)

| CH. No | CH. Freq. | CH. No | CH. Freq. | CH. No | CH. Freq. |
|--------|-----------|--------|-----------|--------|-----------|
| 1      | 462.5625  | 13     | 467.6875  | 25     |           |
| 2      | 462.5875  | 14     | 467.7125  | 26     |           |
| 3      | 462.6125  | 15     | 462.5500  | 27     |           |
| 4      | 462.6375  | 16     | 462.5750  | 28     |           |
| 5      | 462.6625  | 17     | 462.6000  | 29     |           |
| 6      | 462.6875  | 18     | 462.6250  | 30     |           |
| 7      | 462.7125  | 19     | 462.6500  | 31     |           |
| 8      | 467.5625  | 20     | 462.6750  | 32     |           |
| 9      | 467.5875  | 21     | 462.7000  | 33     |           |
| 10     | 467.6125  | 22     | 462.7250  | 34     |           |
| 11     | 467.6375  | 23     |           | 35     |           |
| 12     | 467.6625  | 24     |           | 36     |           |

\* Channels 8~14 are low-power FRS license free channels

### NOAA WEATHER (WX) RADIO FREQUENCY CHART (MHz)

| CH. No | CH. Freq. | CH. No | CH. Freq. |
|--------|-----------|--------|-----------|
| 1      | 162.550   | 6      | 162.500   |
| 2      | 162.400   | 7      | 162.525   |
| 3      | 162.475   | 8      | 161.650   |
| 4      | 162.425   | 9      | 161.775   |
| 5      | 162.450   | 10     | 163.275   |

\* Channels 8, 9 and 10 are designated Canadian Marine Frequencies

### PRIVACY CODES FREQUENCY CHART (Hz)

| Code | Freq. | Code | Freq. | Code | Freq. | Code | Freq. | Code | Freq. |
|------|-------|------|-------|------|-------|------|-------|------|-------|
| 1    | 67.0  | 9    | 91.5  | 17   | 118.8 | 25   | 156.7 | 33   | 210.7 |
| 2    | 71.9  | 10   | 94.8  | 18   | 123.0 | 26   | 162.2 | 34   | 218.1 |
| 3    | 74.4  | 11   | 97.4  | 19   | 127.3 | 27   | 167.9 | 35   | 225.7 |
| 4    | 77.0  | 12   | 100.0 | 20   | 131.8 | 28   | 173.8 | 36   | 233.6 |
| 5    | 79.7  | 13   | 103.5 | 21   | 136.5 | 29   | 179.9 | 37   | 241.8 |
| 6    | 82.5  | 14   | 107.2 | 22   | 141.3 | 30   | 186.2 | 38   | 250.3 |
| 7    | 85.4  | 15   | 110.9 | 23   | 146.2 | 31   | 192.8 |      |       |
| 8    | 88.5  | 16   | 114.8 | 24   | 151.4 | 32   | 203.5 |      |       |

Note: Privacy codes can be programmed for use on Channels 1~22 only

## DCS PRIVACY CODE CHART

| No. | CODE | No. | CODE | No. | CODE |
|-----|------|-----|------|-----|------|
| 1   | 023  | 29  | 174  | 57  | 445  |
| 2   | 025  | 30  | 205  | 58  | 464  |
| 3   | 026  | 31  | 223  | 59  | 465  |
| 4   | 031  | 32  | 226  | 60  | 466  |
| 5   | 032  | 33  | 243  | 61  | 503  |
| 6   | 043  | 34  | 244  | 62  | 506  |
| 7   | 047  | 35  | 245  | 63  | 516  |
| 8   | 051  | 36  | 251  | 64  | 532  |
| 9   | 054  | 37  | 261  | 65  | 546  |
| 10  | 065  | 38  | 263  | 66  | 565  |
| 11  | 071  | 39  | 265  | 67  | 606  |
| 12  | 072  | 40  | 271  | 68  | 612  |
| 13  | 073  | 41  | 306  | 69  | 624  |
| 14  | 074  | 42  | 311  | 70  | 627  |
| 15  | 114  | 43  | 315  | 71  | 631  |
| 16  | 115  | 44  | 331  | 72  | 632  |
| 17  | 116  | 45  | 343  | 73  | 654  |
| 18  | 125  | 46  | 346  | 74  | 662  |
| 19  | 131  | 47  | 351  | 75  | 664  |
| 20  | 132  | 48  | 364  | 76  | 703  |
| 21  | 134  | 49  | 365  | 77  | 712  |
| 22  | 143  | 50  | 371  | 78  | 723  |
| 23  | 152  | 51  | 411  | 79  | 731  |
| 24  | 155  | 52  | 412  | 80  | 732  |
| 25  | 156  | 53  | 413  | 81  | 734  |
| 26  | 162  | 54  | 423  | 82  | 743  |
| 27  | 165  | 55  | 431  | 83  | 754  |
| 28  | 172  | 56  | 432  | -   | -    |

Note: Privacy codes can be programmed for use on Channels 1~22 only



2-Way Radios



Weather Radios



Bluetooth Headsets



HD Wearable Video Cameras



Marine Radios



Emergency Crank Radios



CB Radios

Check out these and other great products at  
[midlandusa.com](http://midlandusa.com)



**LIMITED WARRANTY (United States and Canada)**

Subject to the exclusions set forth below, Midland Radio Corporation will repair or replace, at its option without charge, any Midland FRS/GMRS transceiver which fails due to a defect in material or workmanship within Three Years following the initial consumer purchase.

This warranty does not apply to water damage, battery leak, abuse or misuse of unauthorized accessories, unauthorized service or modification or altered products. Accessories have a 90 day warranty from date of purchase, including any chargers, microphones, and cables.

This warranty does not include the cost of labor for removal or re-installation of the product in a vehicle or other mounting.

ANY IMPLIED WARRANTIES, INCLUDING, WITHOUT LIMITATION THE IMPLIED WARRANTIES OF MERCHANTABILITY AND FITNESS FOR A PARTICULAR PURPOSE, SHALL BE LIMITED AS SET FORTH HEREIN AND TO THE DURATION OF THE LIMITED WARRANTY, OTHERWISE THE REPAIR OR REPLACEMENT AS PROVIDED UNDER THIS EXPRESS LIMITED WARRANTY IS THE EXCLUSIVE REMEDY OF THE CONSUMER AND IS PROVIDED IN LIEU OF ALL OTHER WARRANTIES, EXPRESS OR IMPLIED. IN NO EVENT SHALL MIDLAND BE LIABLE, WHETHER IN CONTRACT OR TORT (INCLUDING BUT NOT LIMITED TO NEGLIGENCE, GROSS NEGLIGENCE, BODILY INJURY, PROPERTY DAMAGE AND DEATH) FOR DAMAGES IN EXCESS OF THE PURCHASE PRICE OF THE PRODUCT OR ACCESSORY, OR FOR ANY INDIRECT, INCIDENTAL, SPECIAL OR CONSEQUENTIAL DAMAGES OF ANY KIND, OR LOSS OF REVENUE OR PROFITS, LOSS OF BUSINESS, LOSS OF INFORMATION OR DATA OR OTHER FINANCIAL LOSS ARISING OUT OF OR IN CONNECTION WITH THE ABILITY OR INABILITY TO USE THE PRODUCTS OR ACCESSORIES TO THE FULL EXTENT THESE DAMAGES MAY BE DISCLAIMED BY LAW.

**For Product Purchased in the USA:**

Performance of any obligation under this warranty may be obtained by returning the warranted product, prepaid freight, along with proof of purchase to:

**Midland Radio Corporation  
Warranty Service Department  
5900 Parretta Drive  
Kansas City, MO 64120**

This warranty gives you specific legal rights, and you may also have other rights, which vary from state to state.

Note: The above warranty applies only to merchandise purchased in the United States of America or any of the territories or possessions thereof, or from a U.S. Military exchange.

**For Product Purchased in Canada:**

Performance of any obligation under this warranty may be obtained by returning the warranted product, along with proof of purchase, to your place of purchase in Canada.

This warranty gives you specified legal rights. Additional warranty rights may be provided by law in some areas within Canada.

## ACCESSORIES

Accessories can be purchased at [midlandusa.com](http://midlandusa.com) or by filling in the form on the following page and mailing it to the address on the form.

### AVP1



- 2 Over the Ear  
Mic. Headsets  
w/ PTT

- **\$19.99**

### AVPH4



- 2 Ear Wrap  
Headsets

- **\$39.99**

### AVPH1



- 1 Open Face  
Helmet  
Microphone Kit

- **\$49.99**

### AVPH5



- 2 Behind the  
Head Headsets

- **\$39.99**

### AVPH2



- 1 Closed Face  
Helmet  
Microphone Kit

- **\$49.99**

### AVPH7



- 2 Mossy Oak  
Around the Ear  
Headsets with  
Boom Mic

- **\$39.99**

### AVPH3



- 2 Surveillance  
Headsets

- **\$39.99**

### AVPH8



- 1 Action Throat  
Mic with  
Acoustic Ear  
Tube

- **\$39.99**

## ACCESSORIES ORDER FORM

Please send Money Order or fill in Visa/MasterCard information and mail to the address below. Please **DO NOT** send cash or checks. Make Money Order payable to Midland Radio Corporation.

Name: \_\_\_\_\_

Address: \_\_\_\_\_

City: \_\_\_\_\_ State: \_\_\_\_\_ Zip Code: \_\_\_\_\_

Tel: \_\_\_\_\_ Email: \_\_\_\_\_

CC#: \_\_\_\_\_ Type: \_\_\_\_\_ Exp.: \_\_\_\_\_

| Qty | Item  | Price   | Total |
|-----|-------|---------|-------|
|     | AVP1  | \$19.99 |       |
|     | AVPH1 | \$49.99 |       |
|     | AVPH2 | \$49.99 |       |
|     | AVPH3 | \$39.99 |       |
|     | AVPH4 | \$39.99 |       |
|     | AVPH5 | \$39.99 |       |
|     | AVPH7 | \$39.99 |       |
|     | AVPH8 | \$39.99 |       |

### Mail To:

Midland Radio Corporation  
Consumer Dept.  
5900 Parretta Drive  
Kansas City, MO 64120

-----  
Or Call 816.241.8500.

-----  
To order online go to  
**midlandusa.com**

Sub-Total \_\_\_\_\_

Tax (MO, FL, WA only) \_\_\_\_\_

S & H \_\_\_\_\_ \$14.95

(Applies to Domestic U.S. only.  
For Hawaii, Alaska, and Puerto Rico S&H will be \$36.25 for 1lb and \$64.25 for 2lbs or more).

Total \$ \_\_\_\_\_

## **MIDLAND RADIO CORPORATION**

**5900 Parretta Drive  
Kansas City, MO 64120  
Call 816.241.8500**

**We'd love to hear from you! Let us know what you  
think of your new Midland product at**



**or by visiting us at  
*midlandusa.com***

**Note: Features & Specifications are subject to change without notice. MIDLAND is not responsible for unintentional errors or omissions on its packaging.**