

# ITEM # HIT140

## 80A MIG Welder

### Assembly & Operating Instructions



**READ ALL INSTRUCTIONS AND WARNINGS BEFORE USING THIS PRODUCT.**

This manual provides important information on proper operation & maintenance. Every effort has been made to ensure the accuracy of this manual. These instructions are not meant to cover every possible condition and situation that may occur. **We reserve the right to change this product at any time without prior notice.**

**IF THERE IS ANY QUESTION ABOUT A CONDITION BEING SAFE OR UNSAFE, DO NOT OPERATE THIS PRODUCT!**

**HAVE QUESTIONS OR PROBLEMS? CONTACT CUSTOMER SERVICE.**

If you experience a problem or need parts for this product, visit our website <http://www.buffalotools.com> or call our customer help line at **1-636-532-9888**, Monday-Friday, 8 AM - 4 PM Central Time. A copy of the sales receipt is required.

**FOR CONSUMER USE ONLY – NOT FOR PROFESSIONAL USE.**

**KEEP THIS MANUAL, SALES RECEIPT & APPLICABLE WARRANTY FOR FUTURE REFERENCE**

---

# RECOGNIZE SAFETY SYMBOLS, WORDS AND LABELS

## What You Need to Know About Safety Instructions

Warning and Important Safety Instructions appearing in this manual are not meant to cover all possible conditions and situations that may occur. Common sense, caution and care must be exercised when operating or cleaning tools and equipment.

Always contact your dealer, distributor, service agent or manufacturer about problems or conditions you do not understand.



This is the safety alert symbol. It is used to alert you to potential personal injury hazards. Obey all safety messages that follow this symbol to avoid possible injury or death.



**DANGER** indicates an imminently hazardous situation which, if not avoided, will result in death or serious injury.



**WARNING** indicates a potentially hazardous situation which, if not avoided, could result in death or serious injury.



**CAUTION** indicates a potentially hazardous situation which, if not avoided, may result in minor or moderate injury.



**CAUTION** used without the safety alert symbol indicates a potentially hazardous situation which, if not avoided, may result in property damage.

---

## SAFETY

**Welding is dangerous, and may cause damage to you and others, so wear protection when cutting.**

**Professional training is needed before operating the machine.**

- Always wear ANSI-approved eyewear and protective equipment while operating this unit.
- The operator must be qualified personnel with a valid "metal welding/cutting (OFC) operations" operation certificate.
- Cut off power before maintenance or repair.

**WARNING: Electric shock—may lead to serious injury or even death.**

- Install earth device according to the application criteria.
- Never touch the live parts when skin bared or wearing wet gloves/clothes.
- Make sure that you are insulated from the ground and workpiece.
- Make sure that your working position is safe.

**WARNING: Smoke & gas may be harmful to health.**

- Keep the head away from smoke and gas to avoid inhalation of exhaust gas from welding.
- Keep the working environment in good ventilation, use exhaust or ventilation equipment when welding.

**Arc radiation—may damage eyes or burn skin.**

- Wear suitable cutting masks and protective clothing to protect your eyes and body.
- Use suitable masks or screens to protect spectators from harm.

**Improper operation may cause fire or explosion.**

- Welding sparks may result in a fire, so please make sure no combustible materials nearby and pay attention to fire hazard.
- Have a fire extinguisher nearby, and have a trained person to use it.

**WARNING: Hot workpiece may cause severe scalding.**

- Do not contact hot workpiece with bare hands.
- Cooling is needed during continuous use of the welding torch.

**Magnetic fields affect cardiac pacemaker.**

- Pacemaker users should be away from the welding spot before medical consultation.

**Moving parts may lead to personal injury.**

- Keep yourself away from moving parts such as fan.
- All doors, panels, covers and other protective devices should be closed during operation.

---

HIT140 is a gas (use solid wire) & gasless (use flux wire) MIG and MMA welder.

### Specifications

ITEM	HIT140
Power voltage (v)	120
Frequency (HZ)	60
Max no load voltage output (V)	62
Output current (A)	MIG 30-80A/MMA 20-70A
Duty cycle	MIG 80A@30% / MMA 70A@30%
Suitable wire dia. (INCH)	MIG.030 - .035"
Suitable electrode size (INCH)	MMA 1-6-2.0MM 1/16" - 5/64"
Insulation class	F
Protection class	IP21S

Suggested Wire: Solid and Flux Cored Wire

Use with Gas or Without Shielding Gas

Welds Carbon Steel Between 1.2mm-3.0mm

Overload & Thermal Protection

Includes Welding Cable & Electrode Holder, MIG Torch, Grounding Cable & Earth Clamp, Wire Spool,

Clipping Hammer / Brush & Welding Face Shield

Welding Material: Carbon Steel, Stainless Steel, Aluminum, etc.



HIT140

# Assembly

## HOW TO CONNECT TORCH

1. Put back of torch towards to the front panel torch socket.
2. Turn clockwise until it was fully locked.

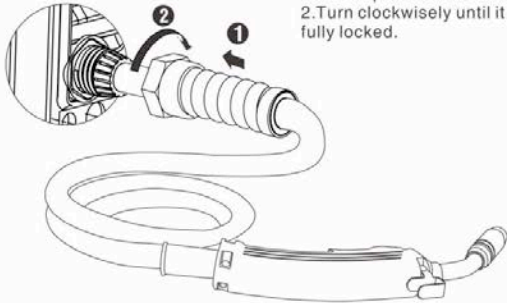

## HOW TO ASSEMBLE THE SPOOL

1. Follow steps in drawing 1 2 3 to assemble.
2. Make sure that do not fix part 2 and 3 too tightly, or it will affect welding.

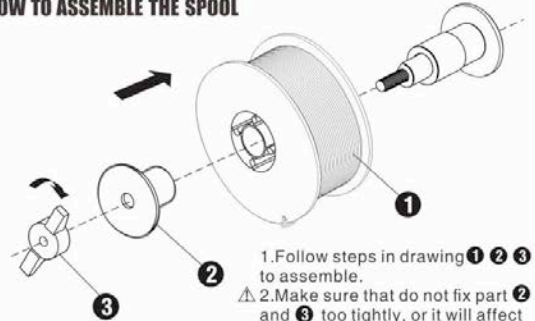

## HOW TO FIX SPOOL OF WIRE TO THE FEEDER

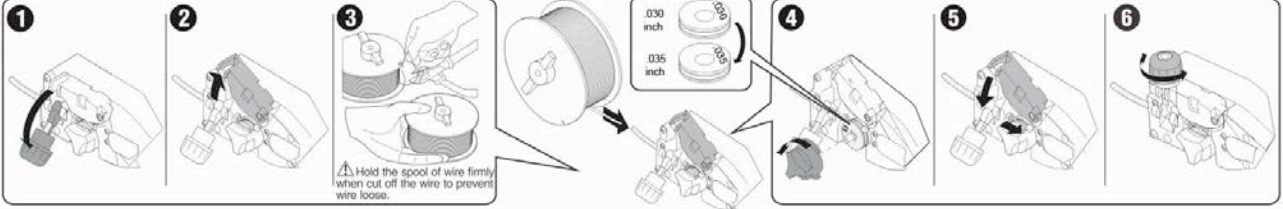

## B (FOR GASLESS WELDING)

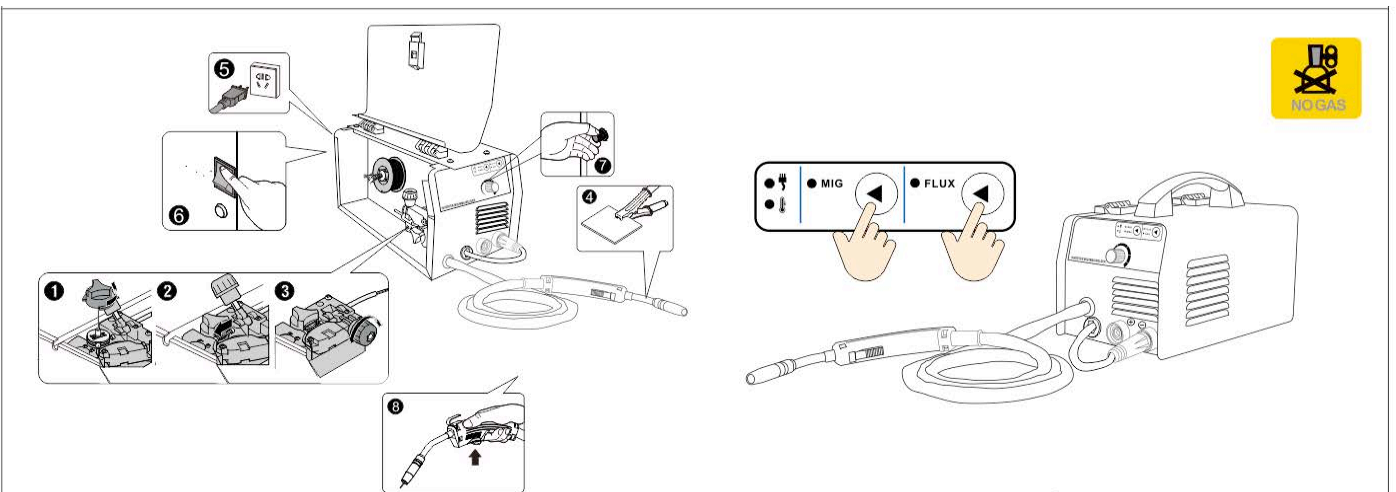

### C (FOR GAS WELDING )

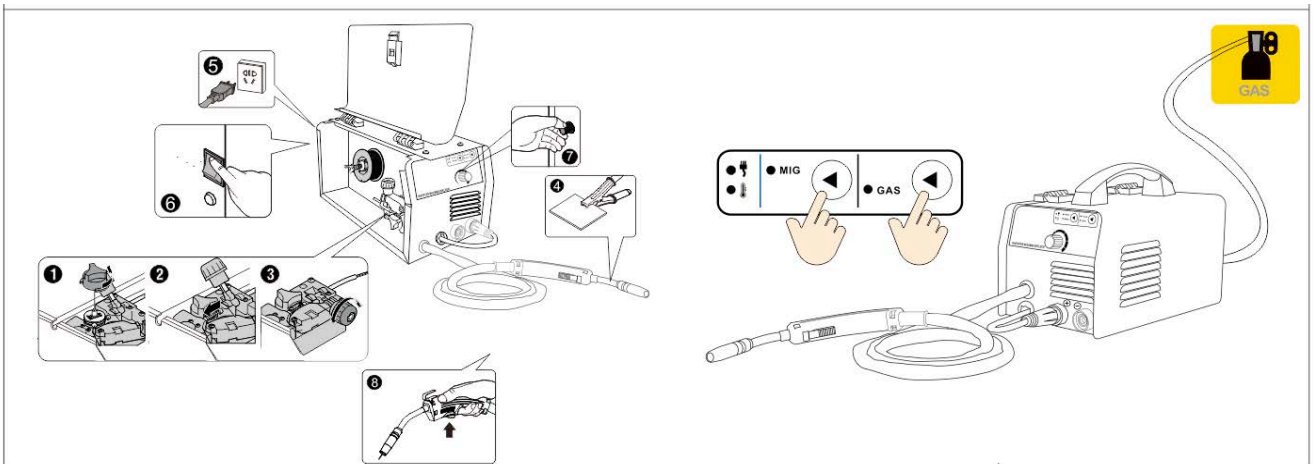

### D (FOR MMA WELDING )

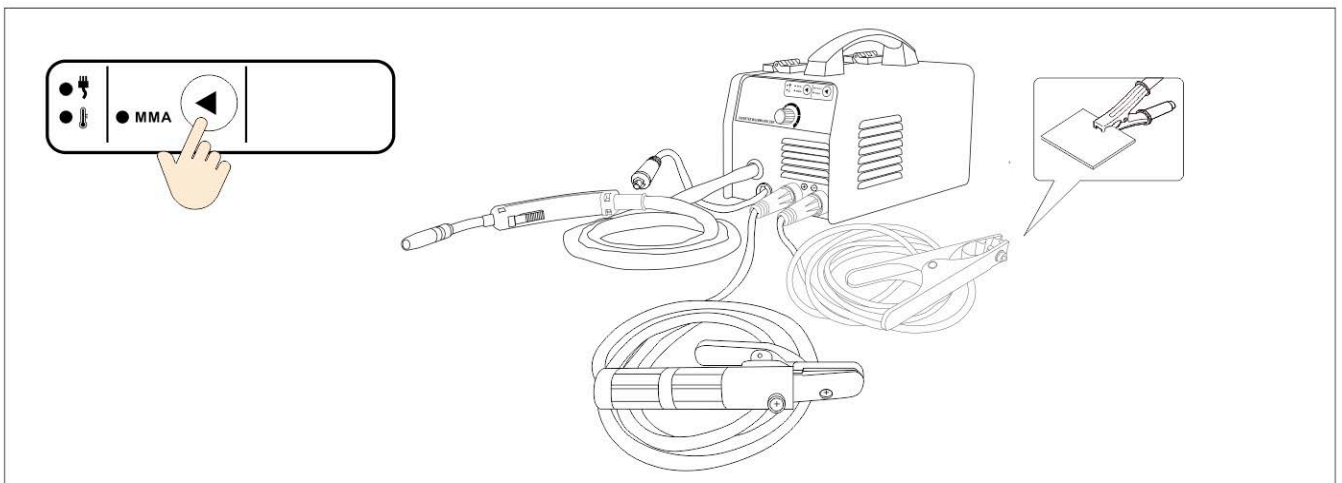

---

## CAUTION ! ! ! !

### 1. WORKING ENVIRONMENT



- 1) BEST TO WORK IN DRY PLACES, NOT TOO WET OR RAINY OR FULL OF DUST ETC.
- 2) KEEP TEMPERATURE BETWEEN 14°F TO 140°F.

### 2. SAFETY

- 1) Please keep the machine cool, make sure the fan is working and not blocked.
- 2) The working voltage is AC 120V±15%, if lower or higher than this, it will cause damage.
- 3) The welder will automatic recover and work again when cooled down.

### 3. USE CORRECT CONSUMABLES

During welding, the working temperature is very hot and will cause the head of torch to be easily damaged. Please change often.

## Installation

### 1. Power requirement

AC single phase 120v (110-120V), 60HZ with a 20 amp time delayed fuse or circuit breaker is required.

DO NOT OPERATE THIS UNIT if the ACTUAL power source voltage is less than 105 volts AC or greater than 132 volts AC.

#### **▲WARNING**

- High voltage danger from power source! Consult a qualified electrician for proper installation of receptacle. This welder must be grounded while in use to protect the operator from electrical shock.
- Do not remove grounding prong or alter the plug in any way. Do not use any adapters between the welder's power cord and the power source receptacle. Make sure the POWER switch is OFF when connecting your welder's power cord to a properly grounded 120Vac, 60Hz, single phase, 20 amp power source.

### 2. Extension cord

It is strongly recommended that an extension cord should not be used because of the voltage drop it produces. This drop in voltage can affect the performance of the welder. If you need to use an extension cord it must be a

---

#12 gauge cord or larger. Do not use an extension cord over 25 ft. in length.

### 3. Install the wire roller

Before installing any welding wire into the unit, the proper sized groove must be placed into position on the wire drive mechanism. Adjust the drive roller according to the following steps, see following picture of the wire feed mechanism:



3.1. Open the door to the welder drive compartment.

3.2. (see #1) Loosen the tension adjusting wing nut and lifting the Drive Tension Adjustor away from the Drive Tension Arm (see #2). Pull the drive tension arm away from the wire roller.

3.3. If there is wire already installed in the welder, roll it back onto the wire spool by hand-turning the spool counterclockwise. Be careful not to allow the wire to come out of the rear end of the inlet guide tube without holding onto it or it will unspool itself. Put the end of the wire into the hole on the outside edge of the wire spool and bend it over to hold the wire in place. Remove the spool of wire from the spool hub by removing the drive tensioning wing nut and hardware.

3.4. Open the machine door using the "L" type six angle wrench, counterclockwise unscrewing the screw drive roller on the wire, and remove the drive roller.



#2





3.5 Based on the wire diameter, select the correct groove using the following table:

Wire Diameter	Roller Groove
.030 inch	0.8
.035 inch	0.9

The drive roller has two wire size grooves. When installing the drive roller, the number stamped on the drive roller for the wire size you are using should face in. This identifies the inside groove the wire will line up with. Assemble the drive roller onto the drive roller shaft

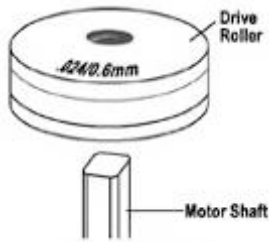

#### 4. Install the wire

##### 4.1 Selecting the wire

Available wire for this machine

Wire Type	Available
MIG wire .023 inch	Yes
MIG wire .030 inch	Yes
Flux core wire .030 inch	Yes
Flux core wire .035 inch	Yes

MIG wires available are: mild steel, stainless steel or aluminum solid wire and must be used with shielding gas.

Four inch spools are available.

#### NOTE:

- Burn through will occur if you attempt to weld mild or stainless steel thinner than 24 gauge.
- Remove all rusted wire, if the whole spool is rusty discard it.

##### 4.2 Install the wire

#### **▲ WARNING**

Electric shock can kill! Always unplug the power cord from the AC power source before installing wire.

---

**NOTE:**

- Before installing, make sure that you have removed any old wire from the torch and cable assembly. This will help to prevent the possibility of the wire jamming inside the Gun Liner.
- Be careful when removing the welding nozzle. The contact tip on this welder is live when the gun trigger is pulled. Make certain POWER is turned OFF.

4.2.1 Remove the nozzle and contact tip from the end of the gun assembly. See following images for reference

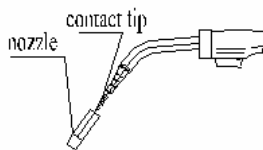

4.2.2 Make sure the proper groove on the drive roller is in place for the wire to be installed. If not, change the drive roller as described above.

4.2.3 Remove the packaging from the spool of wire and then identify the leading end of the wire secured in a hole on the edge of the spool. DO NOT UNHOOK IT AT THIS TIME.

4.2.4 Place the spool on the spool hub with the wire coming off the bottom of the spool. The bottom of the spool aligns with inlet to the drive system for smooth flow of the wire. See following figure.

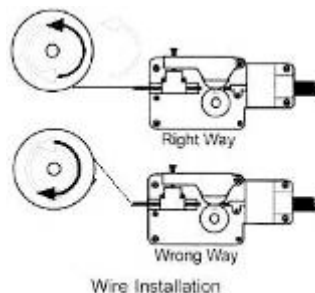

4.2.5 The welder can use 4 inch spools only. The wing nut controls the tension on the spool.

4.2.6.

Setting the wire spool tension:

- a) Turn the spool of wire with one hand.
- b) Increase the spool tension by tightening (turn clockwise) the wing nut while turning the spool. Turn the spool while tightening the wing nut until the spool slows down and operator feels a slight drag.

Stop tightening the wing nut, operator may need to repeat these steps until proper spool tension is achieved.

**NOTE:**

If TOO MUCH tension is applied to the wire spool, the wire will slip on the drive roller or will not be able to feed at all. If TOO LITTLE tension is applied, the spool of wire will want to unspool itself when the trigger is released.

4" Wire Spool



---

Readjust the spool tension using the wing nut as necessary to correct for either problem.

4.2.7. After checking to make sure that your welder is disconnected from the AC power source, free the leading end of the wire from the spool, but DO NOT LET GO OF IT until it is secure in the drive system or the wire will unspool itself.

4.2.8. Using a wire cutter, cut the bent end off the leading end of the wire so that only a straight leading end remains.

4.2.9. Loosen the tension adjusting knob holding the drive tension arm in place and lift the tension arm up off the drive roller.

4.2.10. Insert the leading end of the wire into the inlet guide tube. Then push it across the drive roller and into the MIG gun/torch assembly about six inches.

**▲ CAUTION**

- Make certain that the welding wire is actually going into the torch liner. If not, the wire will jam in the mechanism.

4.2.11 Be sure the wire lines up in the groove of the drive roller then place the drive tension arm back in place above the drive roller.

4.2.12 Position the quick release drive tension back up into position into the drive tension arm.

4.2.13 Tighten (turn clockwise) the drive tension adjusting knob until the tension roller is applying enough force on the wire to prevent it from slipping out of the drive assembly. Do not over tighten.

4.2.14. NOW YOU CAN LET GO OF THE WIRE.

4.2.15. Plug in and turn the welder ON. Set the VOLTAGE switch to the voltage (heat) setting recommended for the gauge metal that is to be welded. Refer to the set up chart on the inside of the wire feed compartment door.

4.2.16. Set the WIRE SPEED control in the middle of the wire speed range.

8.17. Straighten the MIG gun cable, pull the trigger on the welding torch to feed the wire through the torch assembly. When at least one inch of the wire sticks out past the end of the torch, release the trigger.

4.2.18 Turn the Power Switch to the OFF position.

4.2.19 Select a contact tip stamped with the same diameter as the wire being used.

**NOTE:**

Due to inherent variances in flux-cored welding wire, it may be necessary to use a contact tip one size larger than your flux core wire if wire jams occur.

4.2.20. Slide the contact tip over the wire (protruding from the end of the gun). Thread the contact tip into the end of the gun adaptor and tighten securely.

4.2.21. Install the nozzle on the gun assembly. To keep spatter from sticking to inside of the nozzle use anti-spatter spray or gel.

4.2.22 Cut off the excess wire that extends more than 1/4" past the end of the nozzle.

4.2.23. Turn the welder ON

---

## 5. Setting the wire tension

### **▲ WARNING**

Arc flash can injure eyes! To reduce the risk of arc flash, make certain that the wire coming out of the end of the torch does not come in contact with work piece, ground clamp or any grounded material during the drive tension setting process or arcing will occur.

5.1. Press the trigger on the torch.

5.2. Turn the drive tension adjustment knob clockwise, increasing the drive tension until the wire seems to feed smoothly without slipping.

## 6. Gas installation

### **▲ WARNING**

Shielding gas cylinders and high pressure cylinders can explode if damaged, so treat them carefully.

-Never expose cylinders to high heat, sparks, open flames, mechanical shocks or arcs.

-Do not touch cylinder with MIG gun.

-Do not weld on the cylinder.

-Always secure cylinder upright to a cart or stationary object.

-Keep cylinders away from welding or electrical circuits.

-Use the proper regulators, gas hose and fittings for the specific application.

When MIG wire is used, shielding gas is required.

### **1. Polarity changing:**

See page 5 for instructions.

---

## 2. The gas hose, regulator and gas cylinder connections

Connect the gas hose to the gas solenoid valve on the back panel of the welder. Connect the other end to the regulator connected to the shielding gas cylinder. See the following illustration.

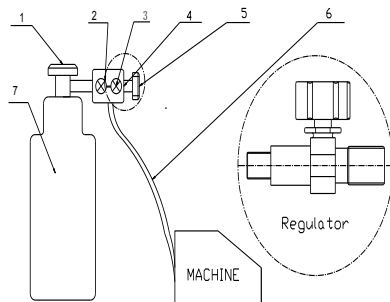

Cylinder valve: Controls GAS CYLINDER flow.

1. Cylinder pressure gauge
2. Gas flow gauge, set at 20 CFM
3. Regulator
4. Adjustment knob: Controls gas flow to the welder.
5. Gas hose
6. Gas cylinder

### NOTE:

Slowly open the cylinder valve by turning it counterclockwise until the cylinder pressure gauge registers the cylinder pressure. Turn the adjustment knob clockwise slowly to increase gas flow to 20 CFM. To reduce the gas flow turn the adjustment counterclockwise. The gas solenoid valve is on the back panel of the welder. Gas flow can be heard at the end of the gun when the trigger is activated. No gas flow will result in a harsh arc with excessive spatter, a smooth weld bead will not be obtained.

## 3. Gas Selection

Different materials require different shielding gas when MIG welding, refer to the set up chart inside the wire feed compartment also.

**Mild steel:** Use 75% Argon and 25% for reduced spatter and reduced penetration for thinner materials.

Do NOT USE Argon gas concentrations higher than 75% on steel. The result will be extremely poor penetration, porosity, and brittleness of weld.

**Mild Steel:** Use CO<sub>2</sub> for deeper penetration but increased spatter.

**Stainless steel:** Use a mixed gas consisting of Helium, Argon and CO<sub>2</sub>.

**Aluminum or bronze:** Use 100% Argon

---

## Operation

### **▲ WARNING**

High voltage danger from power source! Consult a qualified electrician for proper installation of receptacle at the power source. This welder must be grounded while in use to protect the operator from electrical shock. If you are not sure if your outlet is properly grounded, have it checked by a qualified electrician. Do not cut off the grounding prong or alter the plug in any way and do not use any adapters between the welder's power cord and the power source receptacle. Connect your welder's power cord to a properly grounded 120 VAC (110v-120v), 60Hz, single phase, 20 amp power source.

#### **1. Main Control Component**

**Power Knob** - The power knob supplies electrical current to the welder. One knob controls the wire feed, output current and output voltage.

#### **2. Hold the MIG gun**

The best way to hold the MIG gun is the way that feels most comfortable to you. While practicing to use your new welder, experiment holding the torch in different positions until you find the one that seems to work best for you.

#### **3. Position the MIG gun to the work piece**

There are two angles of the MIG gun nozzle in relation to the work piece that must be considered when welding.

3.1. Angle A can be varied, but in most cases the optimum angle will be 60 degrees, the point at which the MIG gun handle is parallel to the work piece. If angle A is increased, penetration will increase. If angle A is decreased, penetration will decrease also.

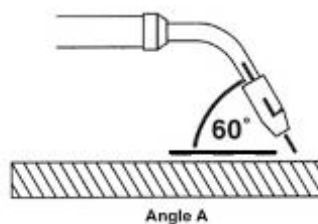

3.2. Angle B can be varied for two reasons: to improve the ability to see the arc in relation to the weld puddle and to direct the force of the arc.

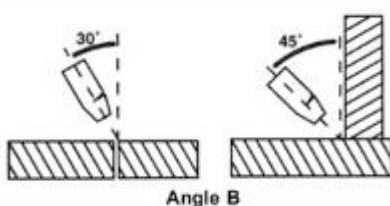

---

#### 4. Distance from the work piece

If the nozzle is held off the work piece, the distance between the nozzle and the work piece should be kept constant and should not exceed 1/4 inch or the arc may begin sputtering, signaling a loss in welding performance.

#### 5. Tuning in the wire speed

This is one of the most important parts of MIG welder operation and must be done before starting each welding job or whenever any of the following variables are changed: wire diameter, or wire type.

### **▲ WARNING**

#### **EXPOSURE TO A WELDING ARC IS EXTREMELY HARMFUL TO THE EYES AND SKIN!**

Prolonged exposure to the welding arc can cause blindness and burns. Never strike an arc or begin welding until you are adequately protected. Wear flameproof welding gloves, a heavy long sleeved shirt, trousers with out cuffs, high topped shoes, and an ANSI approved welding helmet.

5.1. Connect the Ground Clamp to a scrap piece of the same type of material which you will be welding. It should be equal to or greater than the thickness of the actual work piece, and free of oil, paint, rust, etc.

5.2. Hold the torch in one hand, allowing the nozzle to rest on the edge of the work piece farthest away from you, and at an angle similar to that which will be used when welding. (See HOLDING THE TORCH if you are uncertain of the angle at which you will be welding).

5.3. With your free hand, turn the Wire Speed Dial to maximum and continue to hold onto the knob.

5.4. Lower your welding helmet and pull the trigger on the torch to start an arc, then begin to drag the torch toward you while simultaneously turning the Wire Speed Dial counter-clockwise.

5.5. LISTEN! As you decrease the wire speed, the sound that the arc makes will change from a sputtering to a high-pitched buzzing sound and then will begin sputtering again if you decrease the wire speed too much. The point on the wire speed adjustment where the high-pitched buzzing sound is achieved is the correct setting. You can use the wire speed control to slightly increase or decrease the heat and penetration for a given heat setting by selecting higher or lower wire speed settings. Repeat this tune-in procedure if you select a new heat setting, a different diameter wire, or a different type of welding wire.

#### 6. Welding Techniques

### **▲ WARNING**

**EXPOSURE TO A WELDING ARC IS EXTREMELY HARMFUL TO THE EYES AND SKIN!** Prolonged exposure to the welding arc can cause blindness and burns. Never strike an arc or begin welding until you are adequately protected. Wear flameproof welding gloves, a heavy long sleeved shirt, trousers with out cuffs, high topped shoes

---

and an ANSI approved welding helmet.

**ELECTRIC SHOCK CAN KILL!** To prevent ELECTRIC SHOCK, do not perform any welding while standing, kneeling, or lying directly on the grounded work.

### 6.1 Moving the torch

Torch travel refers to the movement of the torch along the weld joint and is broken into two elements: Direction and Speed. A solid weld bead requires that the welding torch be moved steadily and at the right speed along the weld joint. Moving the torch too fast, too slow, or erratically will prevent proper fusion or create a lumpy, uneven bead.

**Travel direction** is the direction the torch is moved along the weld joint in relation to the weld puddle. The torch is either PUSHED into the weld puddle or PULLED away from the weld puddle.

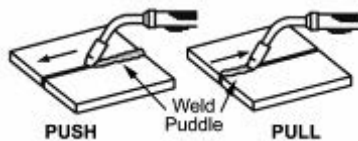

For most welding jobs you will pull the torch along the weld joint to take advantage of the greater weld puddle visibility.

**Travel speed** is the rate at which the torch is being pushed or pulled along the weld joint. For a fixed heat setting, the faster the travel speed, the lower the penetration and the lower and narrower the finished weld bead. Likewise, the slower the travel speed, the deeper the penetration and the higher and wider the finished weld bead.

### 6.2 Types of welding beads

As you become more familiar with your new welder and better at laying some simple weld beads, you can begin to try some different weld bead types.

The STRINGER BEAD is formed by traveling with the torch in a straight line while keeping the wire and nozzle centered over the weld joint. see following figure

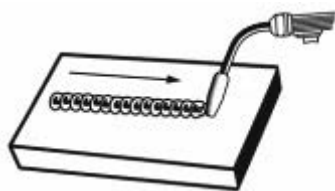

The WEAVE BEAD Used when you want to deposit metal over a wider space than would be possible with a stringer bead. It is made by weaving from side to side while moving with the torch. It is best to hesitate momentarily at each side before weaving back the other way.

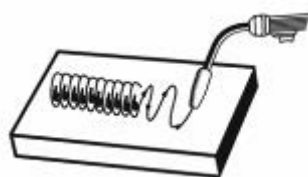

### 6.3 Welding position

FLAT POSITION Is easiest of the welding positions and is most commonly used. It is best if you can weld in the flat



---

position if at all possible as good results are easier to achieve.



**HORIZONTAL POSITION** Is performed very much the same as the flat weld except that angle B (see **HOLDING THE TORCH**) is such that the wire, directed more toward the metal above the weld joint is to help prevent the weld puddle from running downward while still allowing slow enough travel speed. A good starting point for angle B is about 30 degrees **DOWN** from being perpendicular to the work piece.



**VERTICAL POSITION** Is easier for many people to Pull the torch from top to bottom. It can be difficult to prevent the puddle from running downward. Pushing the torch from bottom to top may provide better puddle control and allow slower rates of travel speed to achieve deeper penetration. When vertical welding, angle B (see **HOLDING THE TORCH**) is usually always kept at zero, but angle A will generally range from 45 to 60 degrees to provide better puddle control.

**OVERHEAD POSITION** Is the most difficult welding position. Angle A (see **HOLDING THE TORCH**) should be maintained at 60 degrees. Maintaining this angle will reduce the chances of molten metal falling into the nozzle. Angle B should be held at zero degrees so that the wire is aiming directly into the weld joint. If you experience excessive dripping of the weld puddle, select a lower heat setting. Also, the weave bead tends to work better than the stringer.

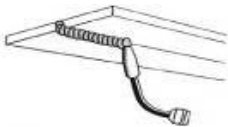

#### **6.4 Multiple pass welding**

**Butt Weld Joints** When butt welding thicker materials, you will need to prepare the edges of the material to be joined by grinding a bevel on the edge of one or both pieces of the metal being joined. When this is done, a “**V**” is created between the two pieces of metal, that will have to be welded closed. In most cases more than one pass or bead will need to be laid into the joint to close the “**V**”.

Laying more than one bead into the same weld joint is known as a multiple-pass weld.

The illustrations in following figure show the sequence for laying multiple pass beads into a single “**V**” butt joint.

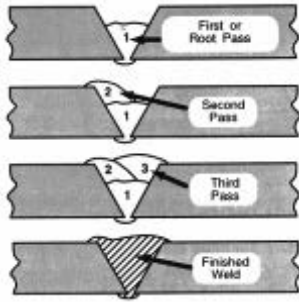

**NOTE:**

WHEN USING SELF-SHIELDING FLUX-CORE WIRE it is very important to thoroughly chip and brush the slag off each completed weld bead before making another pass or the next pass will be of poor quality.

**Fillet Weld Joints.** Most fillet weld joints, on metals of moderate to heavy thickness, will require multiple pass welds to produce strong joint. The illustrations in Figure 19 show the sequence of laying multiple pass beads into a T fillet joint and a lap fillet joint.

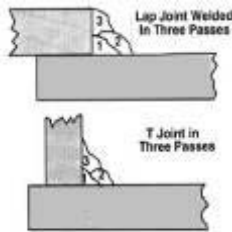

**6.5 Spot welding**

There are three methods of spot welding: Burn-Through, Punch and Fill, and Lap. Each has advantages and disadvantages depending on the specific application as well as personal preference.



1. The BURN-THROUGH METHOD welds two overlapped pieces of metal together by burning through the top piece and into the bottom piece. With the burn-through method, larger wire diameters tend to work better than smaller diameters. Wire diameters that tend to work best, with the burn-through method are .035 inch self-shielding flux-core wire. Do not use .030 inch self-shielding flux core wires when using the burn-through method unless the metal is VERY thin or excessive filler metal build-up and minimal penetration is acceptable. Always select the HIGH heat setting with the burn-through method and tune in the wire speed prior to making a spot weld.

2. The PUNCH AND FILL METHOD produces a weld with the most finished appearance of the three spot weld methods. In this method, a hole is punched or drilled into the top piece of metal and the arc is directed through the hole to penetrate into the bottom piece. The puddle is allowed to fill up the hole leaving a spot weld that is smooth and flush with the surface of the top piece. Select the wire diameter, heat setting, and tune in the wire speed as if you were welding the same thickness material with a continuous bead.

---

3. The LAP SPOT METHOD directs the welding arc to penetrate the bottom and top pieces, at the same time, right along each side of the lap joint seam. Select the wire diameter, heat setting, and tune in the wire speed as if you were welding the same thickness material with a continuous bead.

### **6.6 SPOT WELDING INSTRUCTIONS**

1. Select the wire diameter and heat setting recommended above for the method of spot welding you intend to use.
2. Tune in the wire speed as if you were going to make a continuous weld.
3. Hold the nozzle piece completely perpendicular to and about 1/4 inch off the work piece.
4. Pull the trigger on the torch and release it when it appears that the desired penetration has been made.
5. Make practice spot welds on scrap metal, varying the length of time you hold the trigger, until a desired spot weld is made.
6. Make spot welds on the actual work piece at desired locations.

## **Maintenance**

The welder needs the regular maintenance as following:

Periodically clean dust, dirt, grease, etc. from your welder. Every six months, or as necessary, remove the cover panel from the welder and air-blow any dust and dirt that may have accumulated inside the welder.

## **TROUBLESHOOTING**

Problem	Correction
1. The wire feeder is not working, no wire coming out from the MIG torch	1. Please check the roller if it is running. 2. Please put the wire deep inside the MIG torch, then push the trigger again.
2. The wire automatic coming out from the MIG torch and non-stop, even push the button of MIG torch	Electric board is broken (change board)
3. Whatever the wire feeder if working, there's no wire coming from the MIG torch, even push the button of MIG torch	First check the trigger of MIG torch, if trigger has a problem, please change a new one; If not OK , then check if the Electric board is broken (change board)
4. The machine is not working, OC light is on, power is on, fan is working	Wait a few minutes, the machine may be over-heated. Allow it to cool
5. The wire feeding speed is not powerful and slowly	The four -angles switch (on the wire feeder) is too tight, make it a little loose

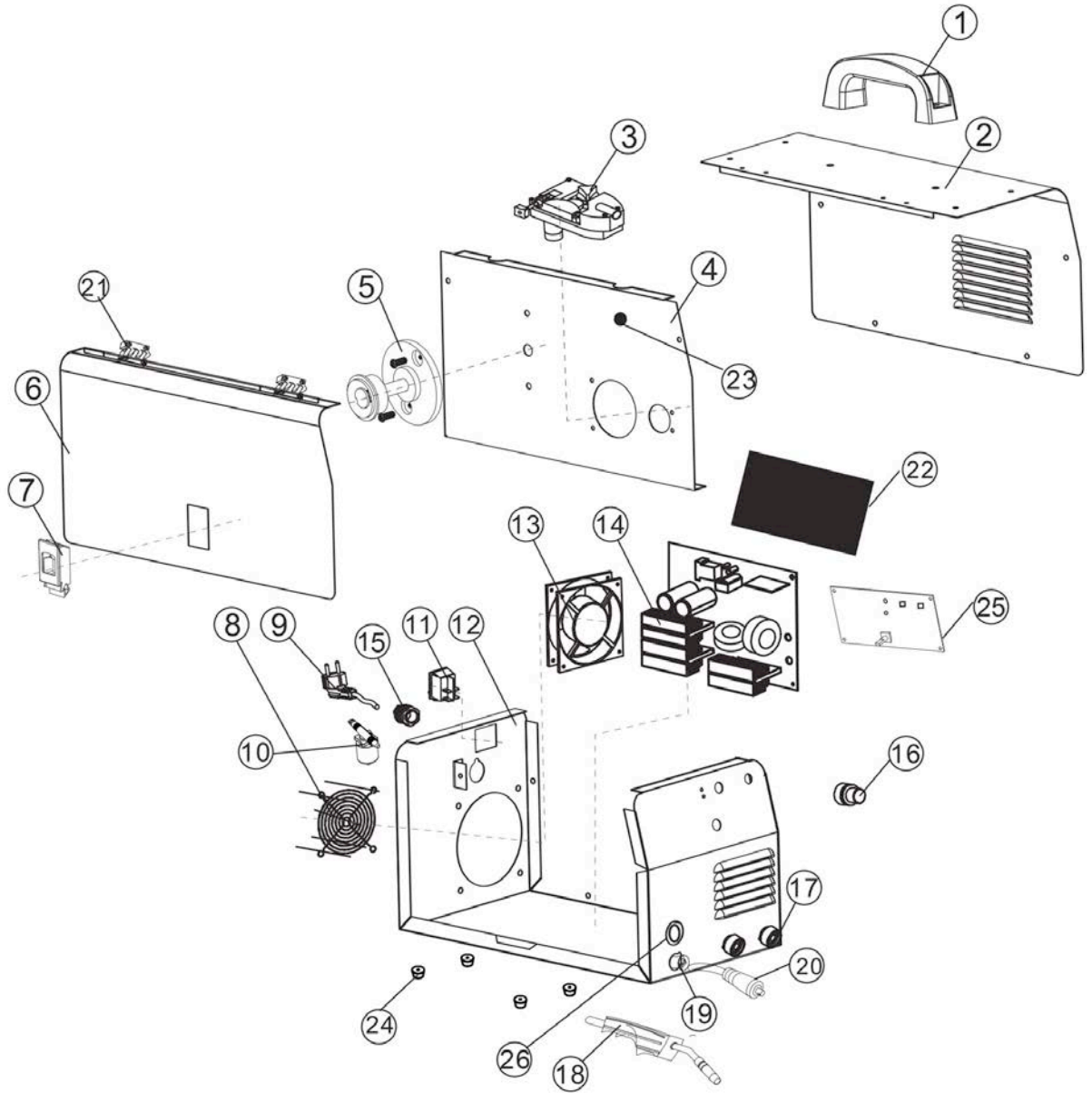

PART #	PART NAME
1	HANDLE
2	LEFT SIDE COVER
3	WIRE FEEDER
4	MIDDLE PANEL
5	WIRE HOLDER
6	RIGHT SIDE COVER
7	LOCK
8	FAN COVER
9	POWER CABLE
10	GAS VALVE
11	POWER SWITCH
12	BOTTOM PANEL
13	FAN
14	PC BOARD
15	WATERJOINT
16	KNOB
17	QUICK CONNECTOR
18	TORCH
19	WATERJOINT
20	MALE CONNECTOR
21	HINGE
22	EPOXY BOARD
23	FAST FEED BUTTON
24	FEET
25	MICRO CONTROL BOARD
26	WATERJOINT