

NeAgePet® Habitat 'n Home Pet Furniture

featuring **ECOFLEX**
GUARANTEED TOUGH

InnPlace™ Pet Crate / End Table

(EHHC100, EHHC400 series)

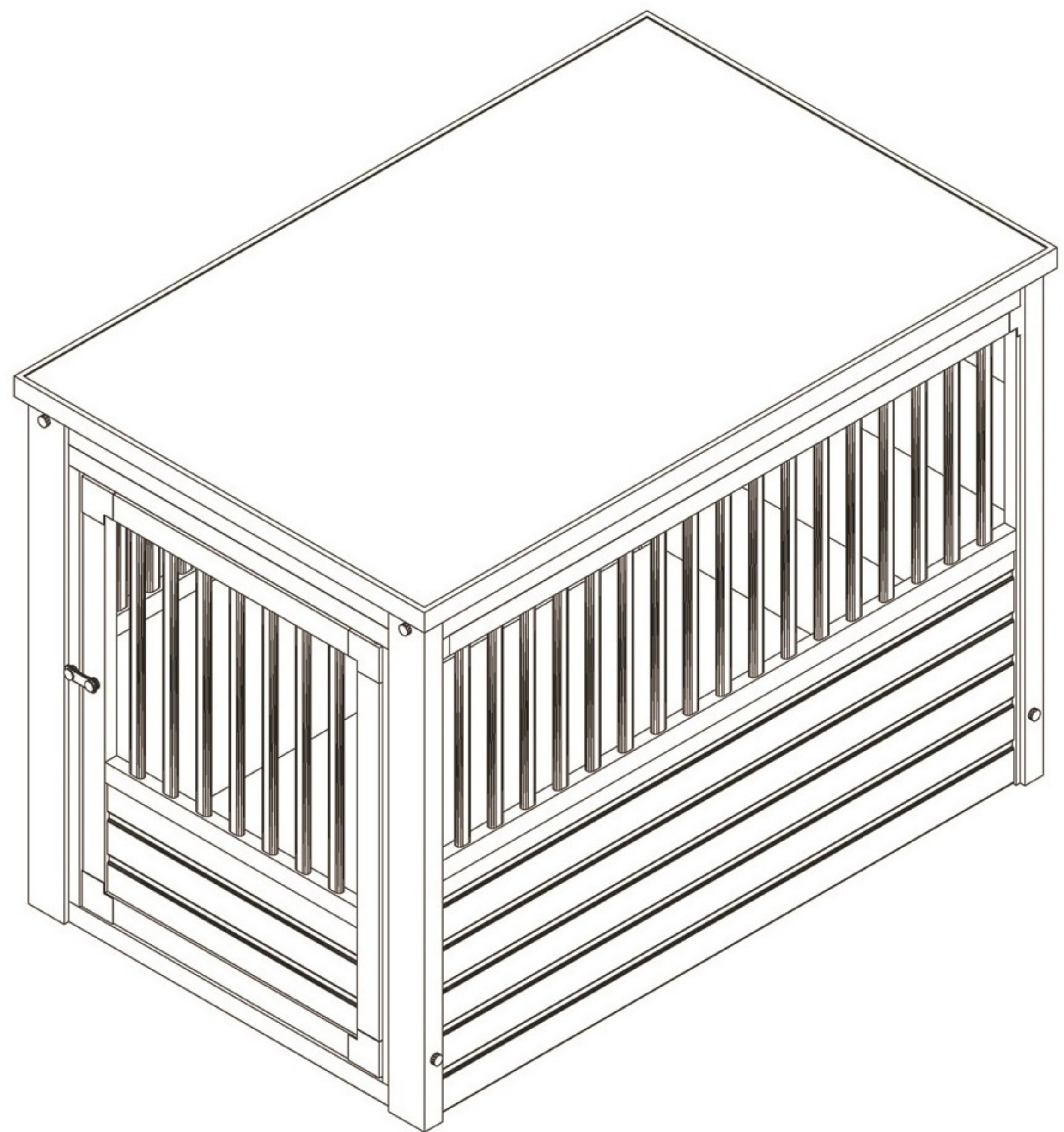

Part List:

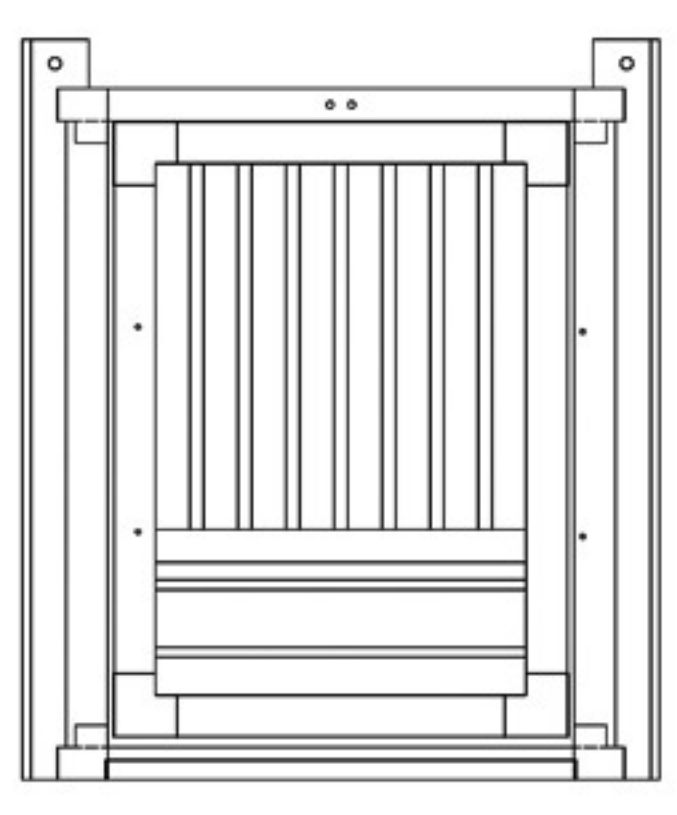

Part 1 X 1

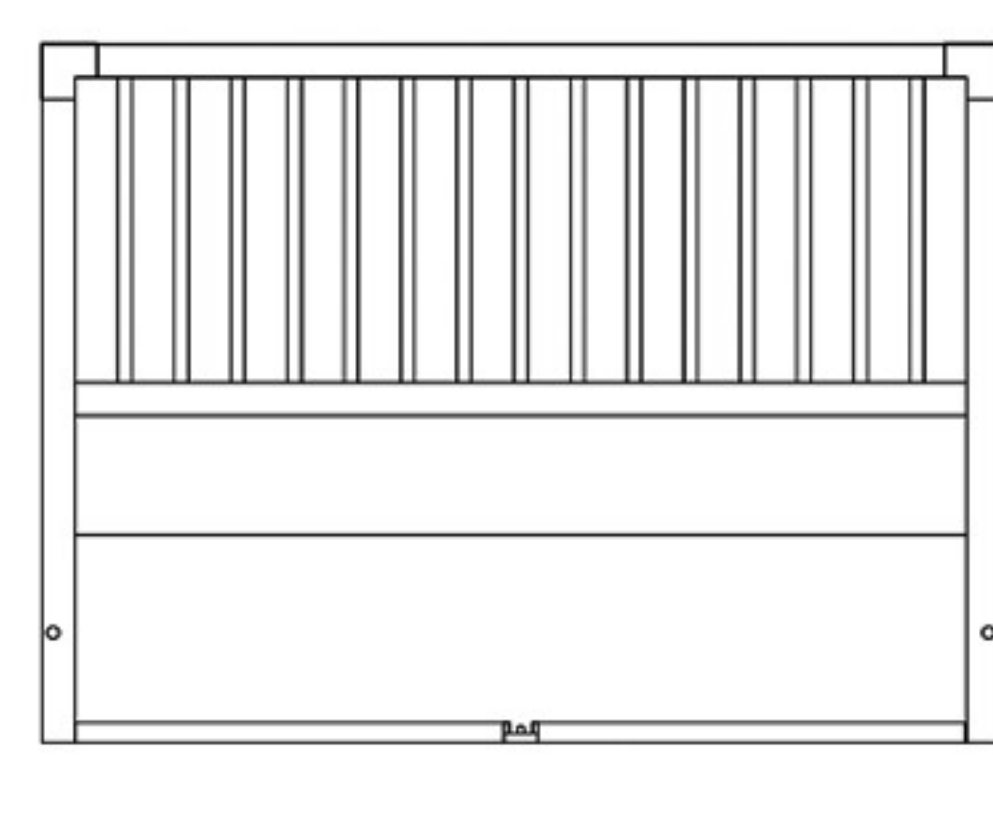

Part 2 X 2

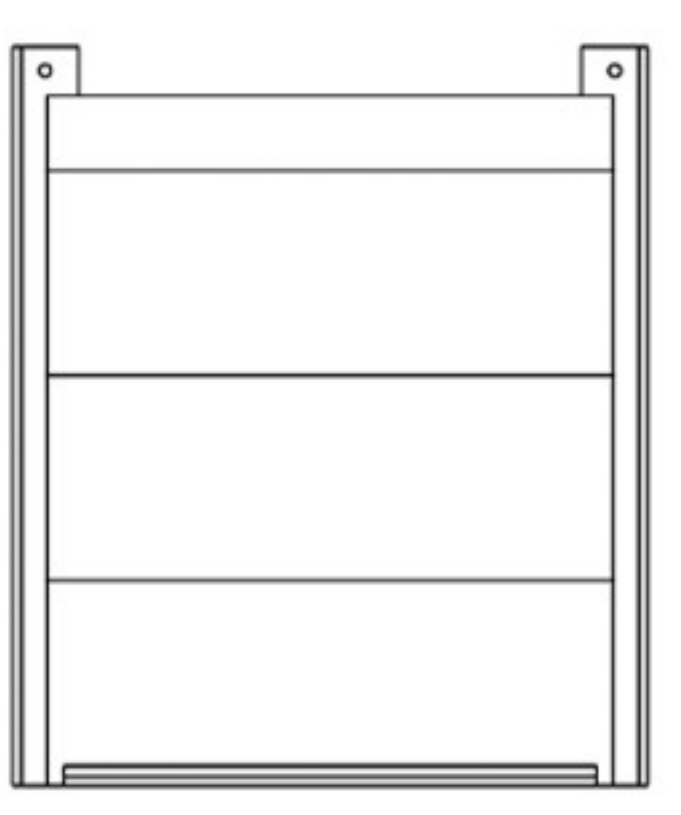

Part 3 X 1



Part 4 X 1

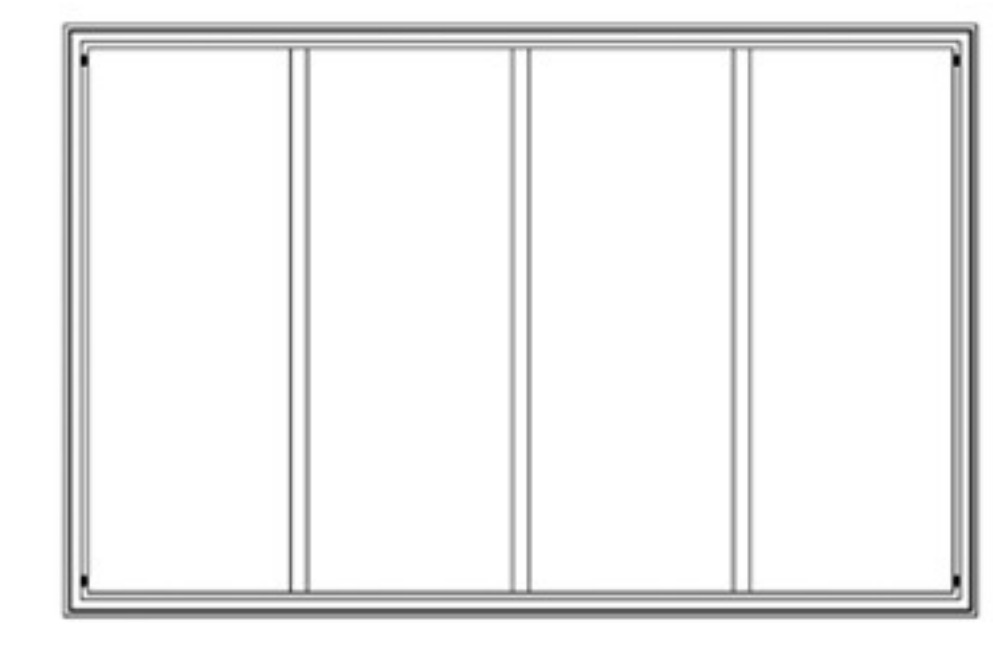

Part 5 X 1

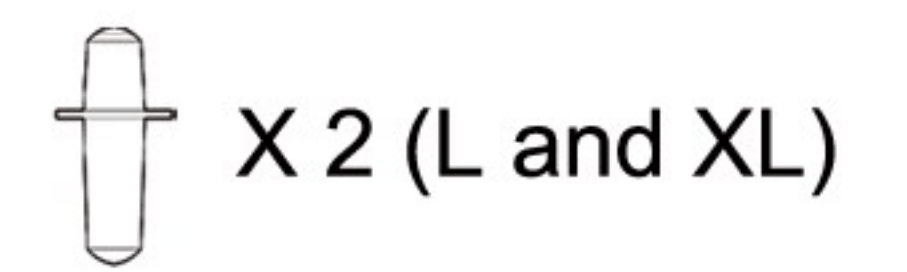
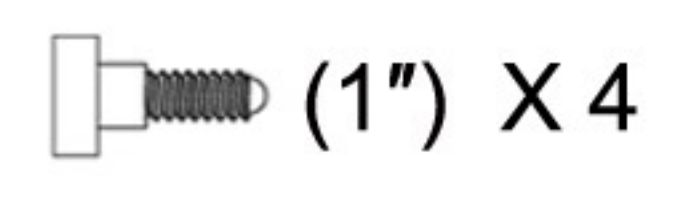
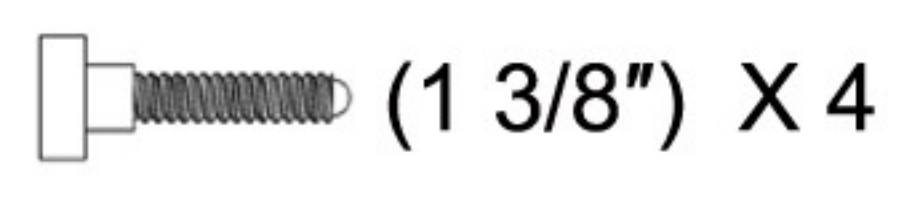

NOT Included with S/M!

NeAgePet®
featuring **ECOFLEX**
GUARANTEED TOUGH

Congratulations and thank you for your purchase! Before you start, please check for damage or any missing parts. Please visit www.NewAgePet.com/customer-service to find additional assembly videos and help in requesting replacement parts, as well as additional instructions on cleaning, maintaining and painting your New Age product.

Felicitaciones y gracias por su compra! Antes de empezar, por favor verifique que el contenido de esta caja este completo y que no se haya dañado ninguna pieza. Para mas informacion visite nuestra pagina web www.NewAgePet.com/customer-service donde encontrara videos de ensamblaje, ayuda para ordenar repuestos, instrucciones de limpieza, mantenimiento y pintura de su nuevo producto New Age.

Félicitations et merci pour votre achat! Avant de commencer, vérifiez s'il y a des dommages ou des pièces manquantes. Visitez www.NewAgePet.com/customer-service pour commander une pièce de rechange ou pour des instructions supplémentaires sur le nettoyage, l'entretien et la peinture de votre produit New Age.

Herzlichen Glückwunsch und vielen Dank für Ihren Einkauf! Bevor Sie beginnen, prüfen Sie die Ware bitte auf Beschädigungen oder fehlende Teile. Bitte besuchen Sie die Website www.NewAgePet.com/customer-service. Sie finden dort zusätzliche Montage-Videos, Hilfe bei der Suche nach Ersatzteilen, sowie zusätzliche Anweisungen für die Reinigung, Pflege und Bemalung Ihres New-Age-Produkts.

