

Recessed Hole



Pre-Checked

### IMPORTANT: READ CAREFULLY BEFORE BEGINNING





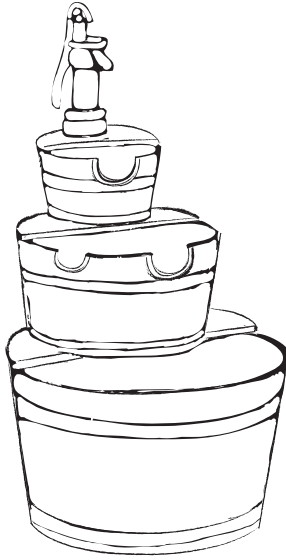

1. Do not tighten bolts until fully assembled.
2. Recessed holes to face outward.
3. Insert bolts with washer and secure with washer and nut.
4. Pre-checked side must always face downward or inward.

# 3 STAGES WATER FALL

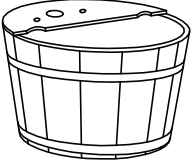
ITEM # TX 93766

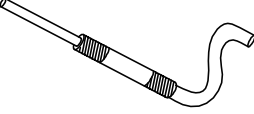

### PARTS AND HARDWARE LIST

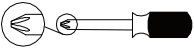
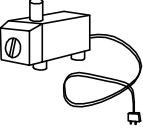
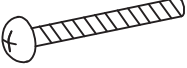
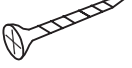
①		②		③					
									
X 1PC		X 1PC		X 1PC					
④		⑤		⑥		⑦			
									
X 1PC		X 1PC		X 3PCS		X 3PCS			
Tools required for assembly				⑧		A NO6-3		B S04-2	
									
Phillips Screwdriver				X 1PC		NUT & BOLT X 4PCS		SCREW X 3PCS	

### STEP 1: Note: Do not tighten all screws until last step

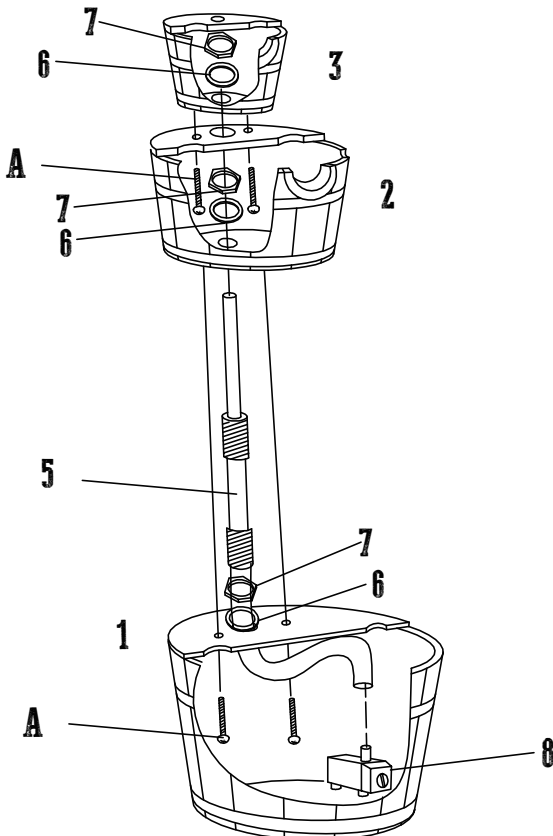

### STEP 2:

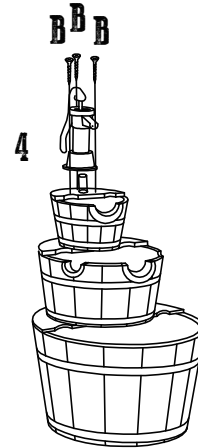

### STEP 3: Finish

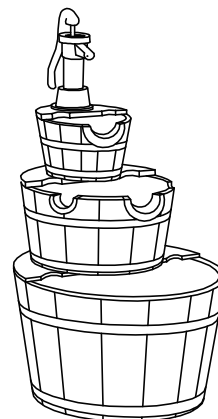

Congratulations on your assembly!