

Pleasant Hearth

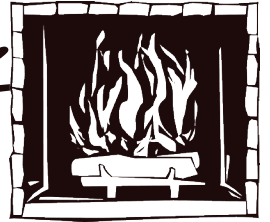

Warming Your Home. Warming Your Heart.

5 PC. SHEFFIELD FIREPLACE TOOLSET

MODEL #FA146TL

Español p.6

Français p.11

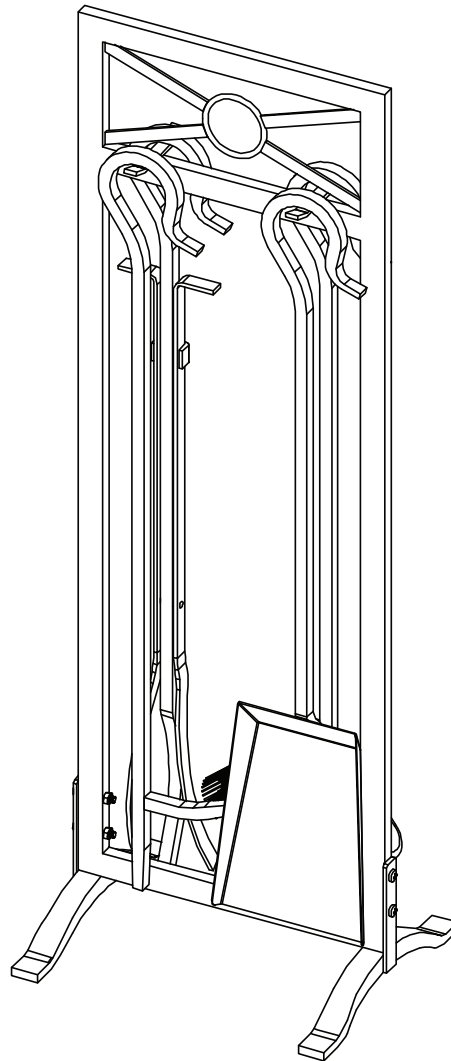

ATTACH YOUR RECEIPT HERE

Serial Number _____ Purchase Date _____



Questions, problems, missing parts? Before returning to your retailer, call our customer service department at 1-877-447-4768, 8:30 a.m. – 4:30 p.m., CST, Monday – Friday.

PACKAGE CONTENTS

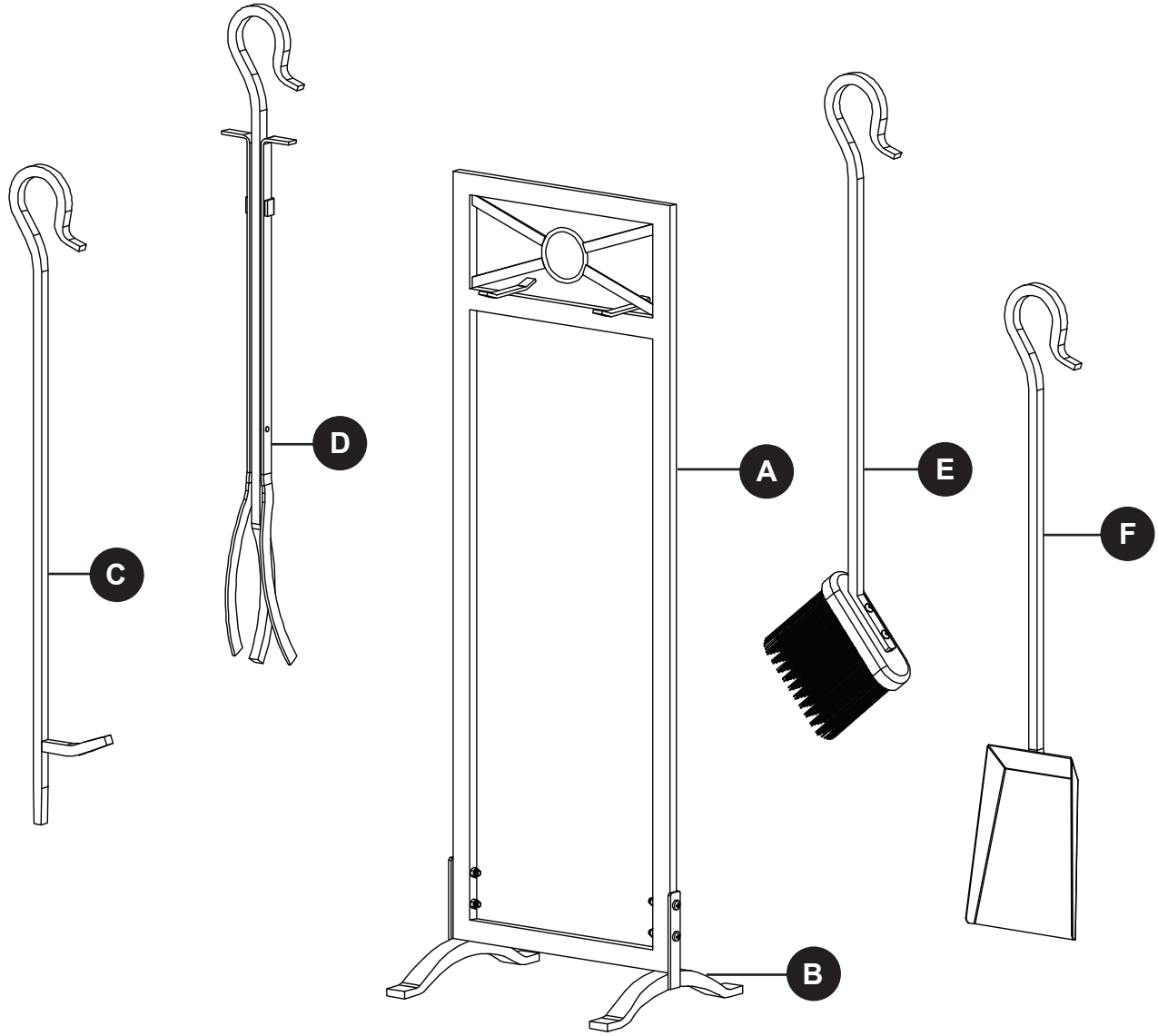

PART	DESCRIPTION	QUANTITY
A	Stand Frame	1
B	Stand Base	2
C	Poker	1
D	Tongs	1
E	Brush	1
F	Shovel	1

HARDWARE CONTENTS (actual size shown)

AA

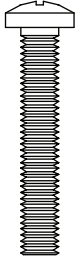

M5 X 30mm
Bolt
Qty. 4

BB



M5 Nut
Qty. 4

CC

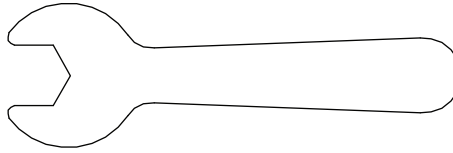

M5 Wrench
Qty. 1



SAFETY INFORMATION

Please read and understand this entire manual before attempting to assemble, operate or install the product.



WARNING

- Do not allow children to play with or around the tool set.
- Do not attempt to clean the tools while they are hot.
- Hot particles may stick to surface of tools.
- **TOOL HANDLES AND TOOLS MAY BECOME HOT DURING AND AFTER USE, USE HEAT-RESISTANT GLOVES TO HANDLE HOT TOOLS.**

PREPARATION

Before beginning assembly of product, make sure all parts are present. Compare parts with package contents list and hardware contents list. If any part is missing or damaged, do not attempt to assemble the product.

Estimated Assembly Time: 10 minutes

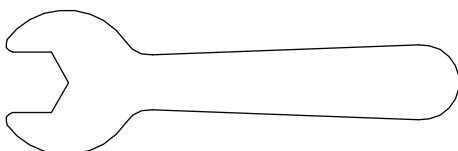

Tools required for assembly: Wrench (included)



ASSEMBLY INSTRUCTIONS

1. Attach stand base (B) to stand frame (A) by inserting 4 bolts (AA) from the bottom through corresponding predrilled holes in the stand base (B) and stand frame (A) and securing with 4 nuts. Tighten securely with wrench provided (CC).

Hardware Used

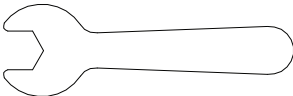
AA	M5 X 30mm Bolt		x 4
BB	M5 Nut		x 4
CC	M5 Wrench		x 1

2. Hang the poker (C), tongs (D), brush (E), and shovel (F) on the stand as illustrated.

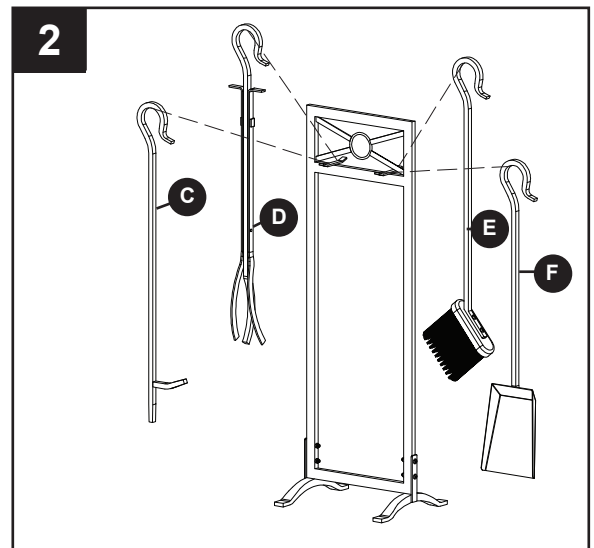
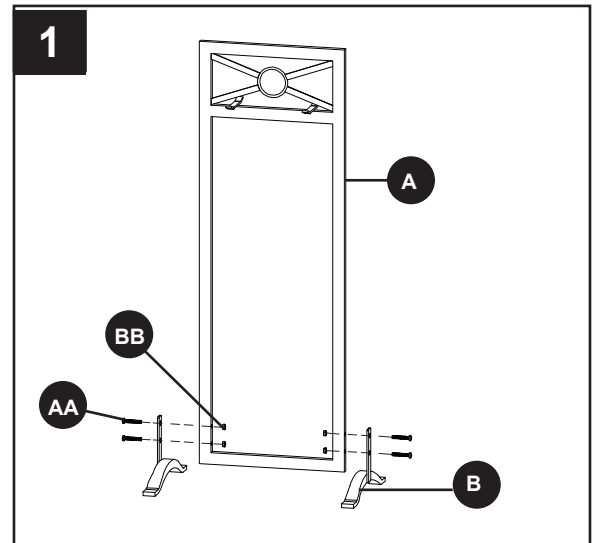

CARE AND MAINTENANCE

- Wipe the tools and stand with a soft cloth.
- Do not use abrasive cleaners as they may cause parts to tarnish or rust.
- Store in a clean, dry place.

1-YEAR LIMITED FRAME WARRANTY

If within one year from the date of original purchase, this item fails due to a defect in material or workmanship, we will replace or repair at our option, free of charge. To order parts or to obtain warranty service, call 1-877-447-4786, Monday - Friday, 8:30 a.m. - 4:30 p.m. CST. This warranty does not cover defects resulting from improper or abnormal use, misuse, accident, or alteration. Failure to follow all instructions in the owner's manual will also void this warranty. The manufacturer will not be liable for incidental or consequential damages, or common erosion of outdoor products. Some states do not allow the exclusion or limitation of incidental or consequential damages, so the above limitation may not apply to you. This warranty gives you specific legal rights, and you may also have other rights which vary from state to state.



GHP Group Inc.
6440 W. Howard St.
Niles, IL 60714-3302
877-447-4768

REPLACEMENT PARTS LIST

For replacement parts, call our customer service department at 1-877-447-4768, 8:30 a.m.-4:30 p.m., CST, Monday - Friday.

PART	DESCRIPTION	PART #
A	Stand Frame	40-01-141
B	Stand Base	40-01-142
C	Poker	40-04-413
D	Tongs	40-02-257
E	Brush	40-06-615
F	Shovel	40-03-368
HWP	Hardware Pack	40-09-504
N/A	Instruction Manual	40-10-232

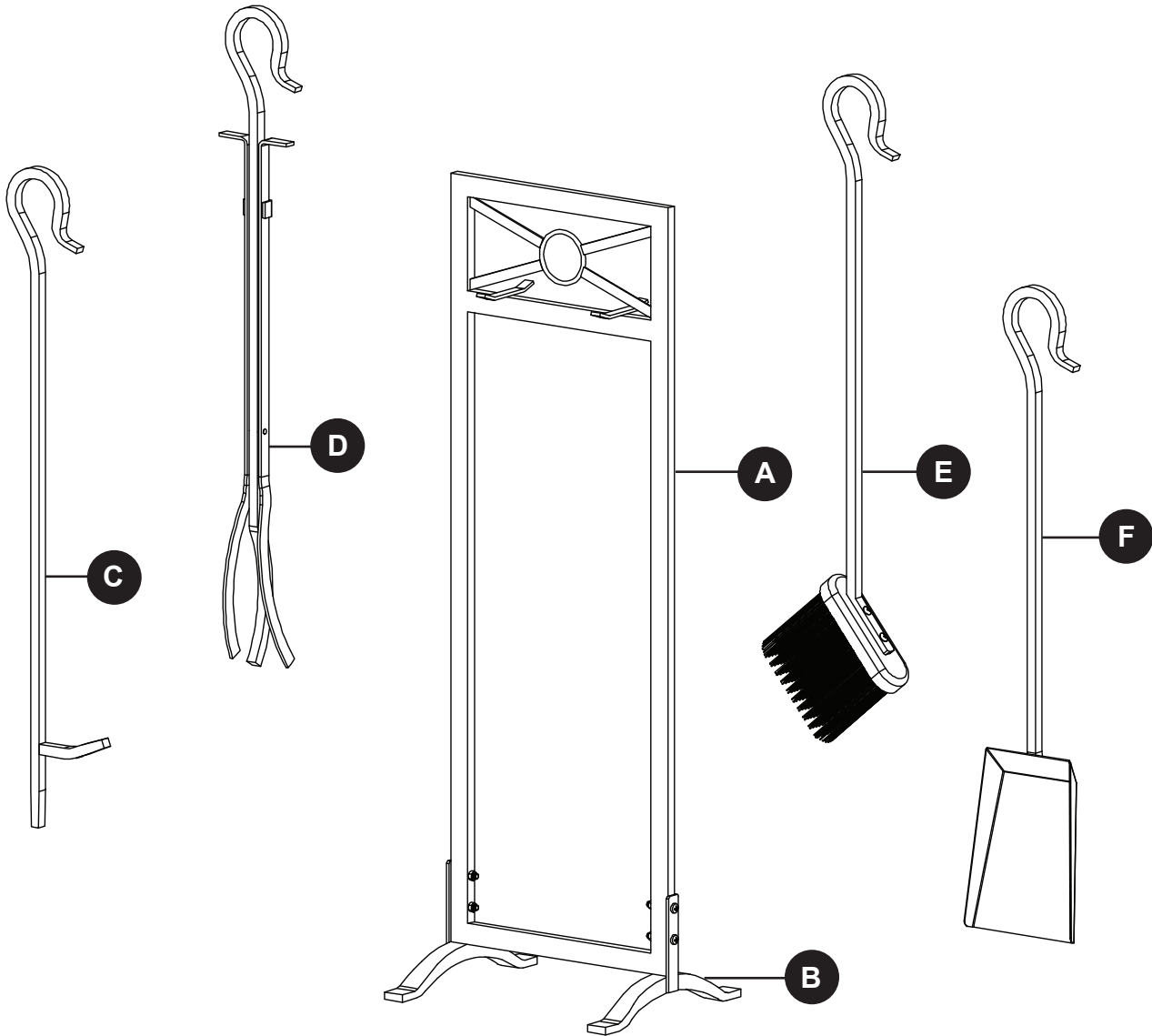
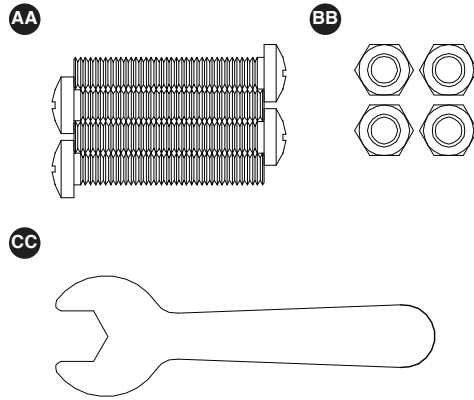

Pleasant Hearth

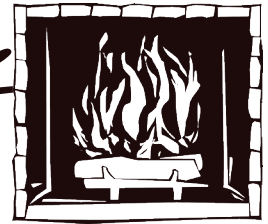

Warming Your Home. Warming Your Heart.

CONJUNTO DE 5 HERRAMIENTAS PARA EL HOGAR SHEFFIELD

MODELO #FA146TL

English p.1

Français p.11

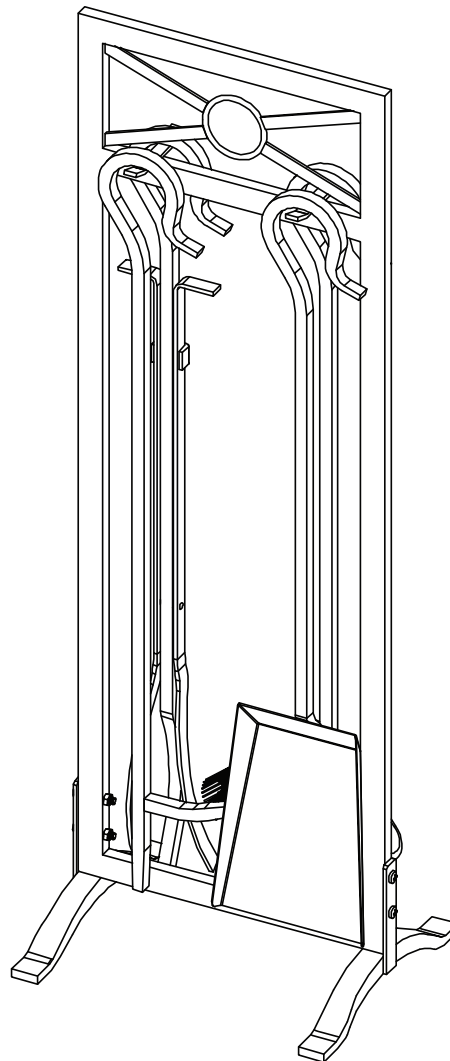

ADJUNTE SU RECIBO AQUÍ

Número de serie _____ Fecha de compra _____



¿Preguntas, problemas, piezas faltantes?

Antes de volver a la tienda, llame a nuestro departamento de servicio al cliente al 1-877-447 4768, de lunes a viernes de 8:30 a.m. a 4:30 p.m., hora central estándar o envíenos un correo electrónico a customerservice@ghpgroupinc.com

CONTENIDO DEL PAQUETE

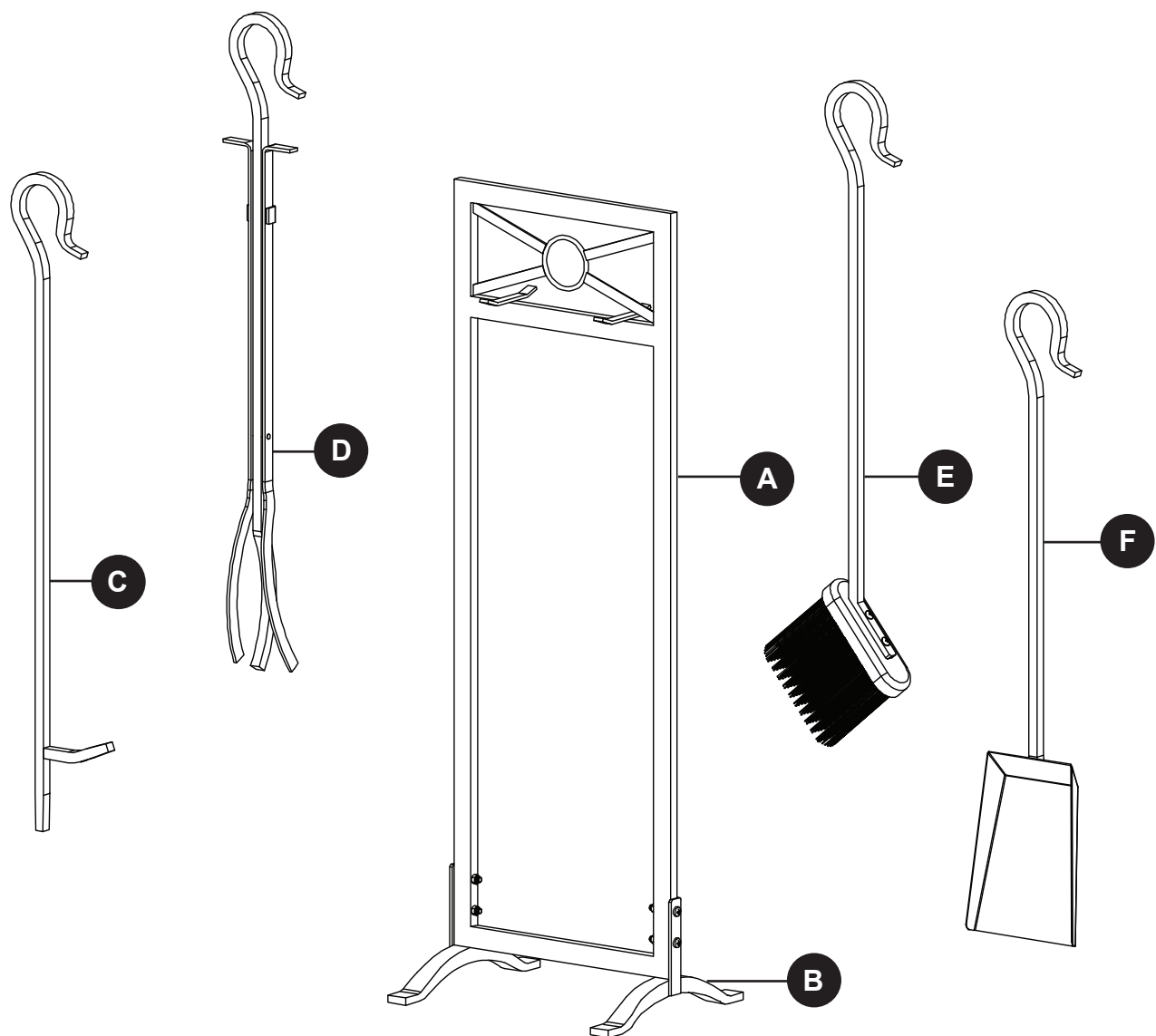

PIEZA	DESCRIPCIÓN	CANTIDAD
A	Soporte Frame	1
B	Base del soporte	2
C	Atizador	1
D	Tongs	1
E	Cepillo	1
F	Pala	1

ADITAMENTOS (Se muestran en tamaño real)

AA

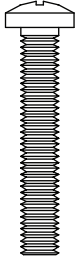

M5 X 30mm
Perno
Cant. 4

BB



M5 Tuerca
Cant. 4

CC

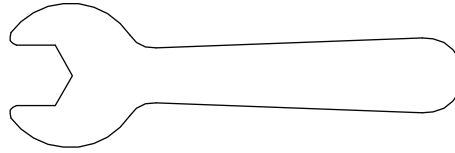

M5 Llave de tuercas
Cant. 1



INFORMACIÓN DE SEGURIDAD

Lea y comprenda completamente este manual antes de intentar ensamblar, usar o instalar el producto.



ADVERTENCIA

- No permita que los niños jueguen con las herramientas o cerca de ellas.
- No trate de limpiar las herramientas mientras están calientes.
- Las partículas calientes pueden adherirse a la superficie de las herramientas.
- **LAS MANIJAS DE LAS HERRAMIENTAS Y LAS HERRAMIENTAS SE PUEDEN CALENTAR DURANTE Y DESPUÉS DEL USO, USE GUANTES RESISTENTES AL CALOR PARA MANIPULAR LAS HERRAMIENTAS CALIENTES.**

PREPARACIÓN

Piezas con la lista del contenido del paquete y la lista de aditamentos. No intente ensamblar el producto si falta alguna pieza o si estas están dañadas.

Tiempo estimado de ensamblaje: 10 minutos

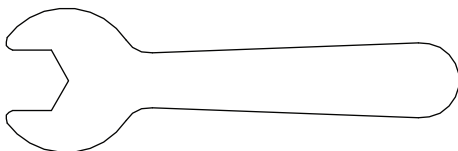

Herramientas necesarios para el ensamblaje: Llave de tuercas (se incluye)



INSTRUCCIONES DE ENSAMBLAJE

1. Fije la base del soporte (B) a la estructura del soporte (A) insertando 2 pernos (AA) desde la parte inferior y a través de los orificios taladrados previamente en la base del soporte (B) y en la estructura del soporte (A) y asegurar con 4 tuercas. Apriete firmemente con llave de tuercas incluye (CC).

Ferreteria utilizado

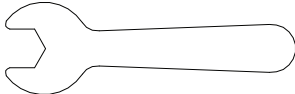
AA	M5 X 30mm Perno		x 4
BB	M5 Tuerca		x 4
CC	M5 Llave de tuercas		x 1

2. Cuelgue el atizador (C), tenazas (D), cepillo (E), y la pala como se muestra

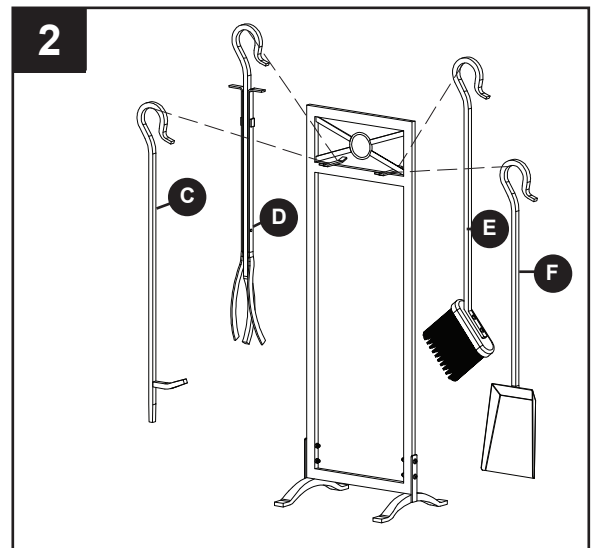
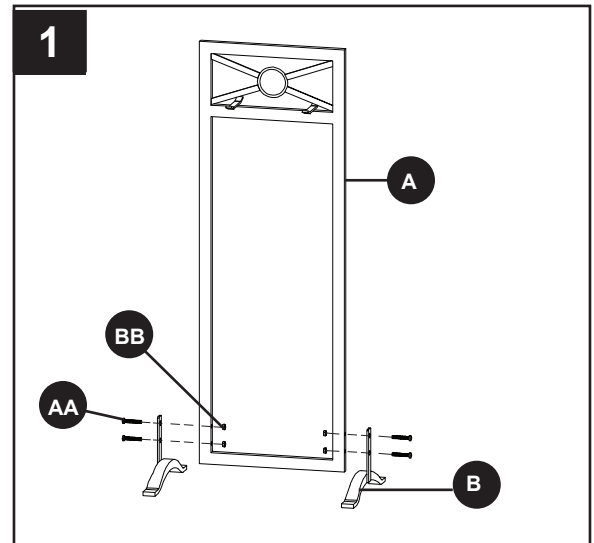

CUIDADO Y MANTENIMIENTO

- Limpie las herramientas y de pie con un paño suave.
- No use limpiadores abrasivos, ya que pueden causar que las partes que empañan ni se oxida.
- Almacene en un lugar limpio y seco.

GARANTÍA LIMITADA DE UN AÑO PARA LA ESTRUCTURA

Si en el lapso de un año a partir de la fecha de compra original este artículo falla debido a un defecto en el material o la mano de obra, lo reemplazaremos o repararemos sin cargos a nuestra discreción. Para hacer un pedido de las piezas o para obtener el servicio de garantía, llame al 1-877-447-4768, de lunes a viernes de 8:30 a.m. a 4:30 p.m., hora estándar central. Esta garantía no cubre defectos que sean producto de un uso incorrecto o anormal, uso indebido, accidente o alteración. No seguir todas las instrucciones del manual del propietario también anulará esta garantía. El fabricante no será responsable de daños accidentales o resultantes. Algunos estados no permiten la exclusión o limitación de los daños accidentales o resultantes, de modo que la exclusión o limitación de estos daños puede no aplicarse en su caso. Esta garantía le otorga derechos legales específicos, pero podría tener también otros derechos que varían según el estado.



GHP Group Inc.
6440 W. Howard St.
Niles, IL 60714-3302
877-447-4768

LISTA DE PIEZAS DE REPUESTO

Para obtener piezas de repuesto, llame a nuestro Departamento de Servicio al Cliente al 1-877-447-4768, de lunes a viernes de 8:30 a.m. a 4:30 p.m., hora central estándar.

PIEZA	DESCRIPCIÓN	PIEZA #
A	Frame del soporte	40-01-141
B	Base del soporte	40-01-142
C	Atizador	40-04-413
D	Tongs	40-02-257
E	Cepillo	40-06-615
F	Pala	40-03-368
HWP	El paquete de ferreteria	40-09-504
N/A	Manual de la instrucción	40-10-232

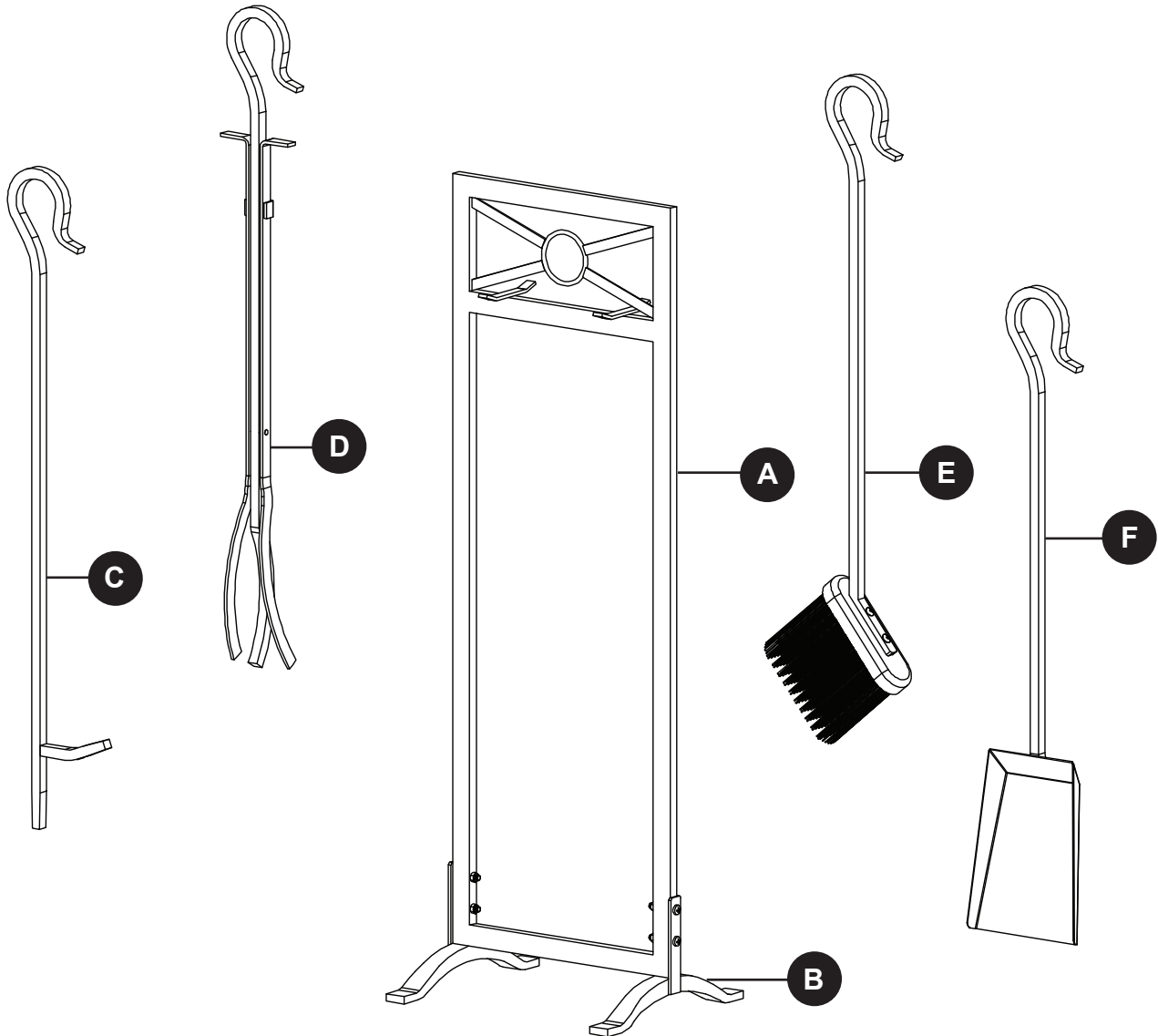
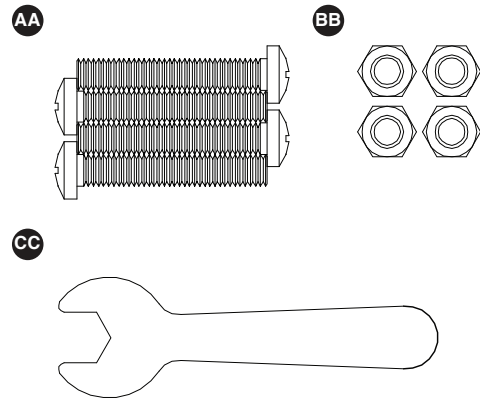

Pleasant Hearth

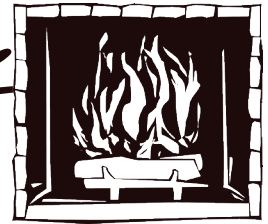

Warming Your Home. Warming Your Heart.

5 UTENSILES DE FOYER DÉCOR SHEFFIELD

MODÈLE #FA146TL

English p. 1

Español p. 6

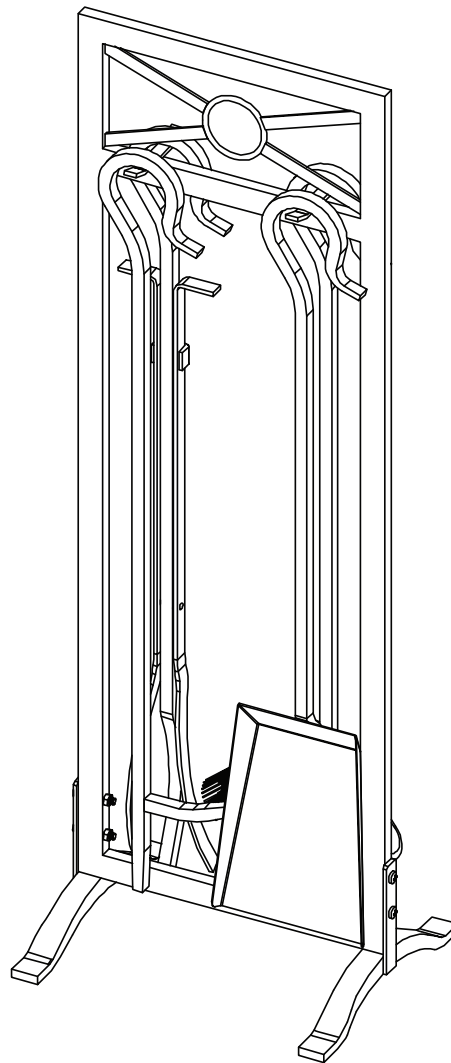

JOIGNEZ VOTRE REÇU ICI

Numéro de série _____ Date d'achat _____



Des questions, des problèmes, des pièces manquantes?

Avant de retourner l'article au détaillant, appelez notre service à la clientèle au 1 877 447-4768, entre 8 h 30 et 16 h 30 (HNC), du lundi au vendredi.

CONTENU DE L'EMBALLAGE

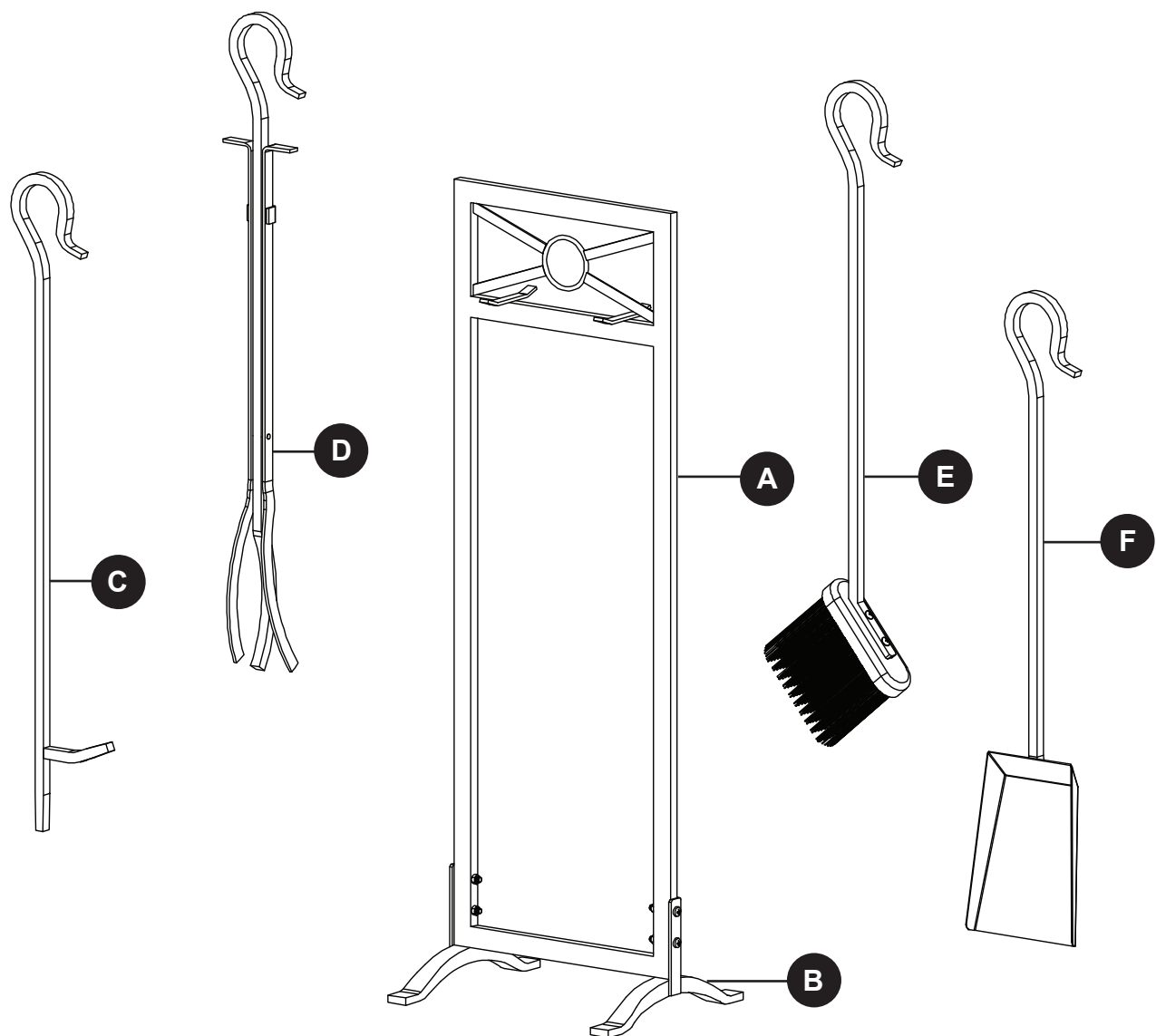

PIÈCE	DESCRIPTION	QUANTITÉ
A	Frame	1
B	Base du porte-outils	2
C	Tissonier	1
D	Tongs	1
E	Brosse	1
F	Pelle	1

QUINCAILLERIE INCLUSE (grandeur réelle)

AA

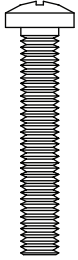

M5 X 30mm
Boulon
Qté 4

BB



M5 Écrou
Qté 4

CC

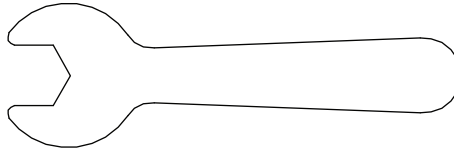

M5 Clé
Qté 1



CONSIGNES DE SÉCURITÉ

Assurez-vous de lire et de comprendre l'intégralité du présent manuel avant de tenter d'assembler, d'installer ou d'utiliser l'article.



AVERTISSEMENT

- Ne laissez pas les enfants jouer avec l'ensemble d'outils ou à proximité de celui-ci.
- Ne tentez pas de nettoyer les outils lorsqu'ils sont chauds.
- Il est possible que des particules brûlantes collent à la surface des outils.
- **LES OUTILS ET LEUR POIGNÉE PEUVENT ÊTRE BRÛLANTS DURANT ET APRÈS L'EMPLOI.**
- **UTILISEZ DES GANTS RÉSISTANT À LA CHALEUR POUR MANIPULER LES OUTILS.**

PRÉPARATION

Avant de commencer l'assemblage du produit, assurez-vous d'avoir toutes les pièces. Comparez le contenu de l'emballage avec la liste des pièces et celle de la quincaillerie. S'il y a des pièces manquantes ou endommagées, ne tentez pas d'assembler le produit.

Temps d'assemblage approximatif: 10 minutes

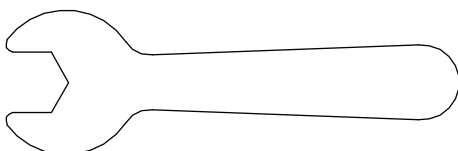

Outils nécessaires pour l'assemblage: Clé (incluse)



INSTRUCTIONS POUR L'ASSEMBLAGE

1. Fixez la base du porte-outils (B) au cadre du porte-outils (A) en insérant deux boulons (AA) en partant du bas dans les trous prépercés correspondants sur la base (B) et sur le cadre (A) et la fixer avec 4 écrous. Renforcer la sécurité avec clé incluse.

matériel utilisé

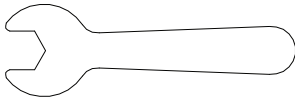
AA	M5 X 30mm Boulon		x 4
BB	M5 Écrou		x 4
CC	M5 Clé		x 1

2. Accrochez la tisonnier

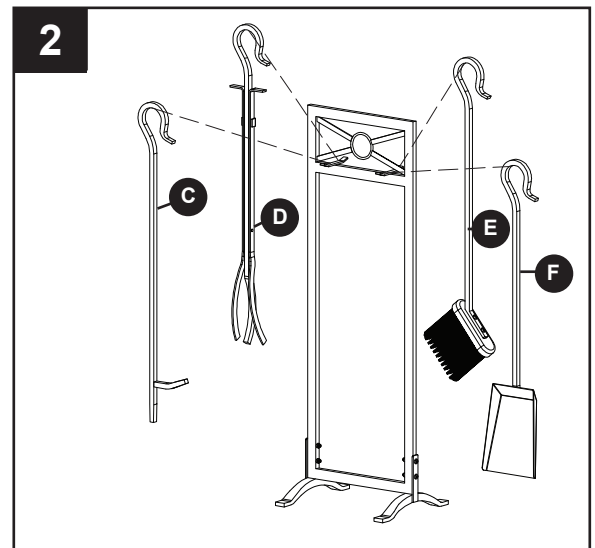
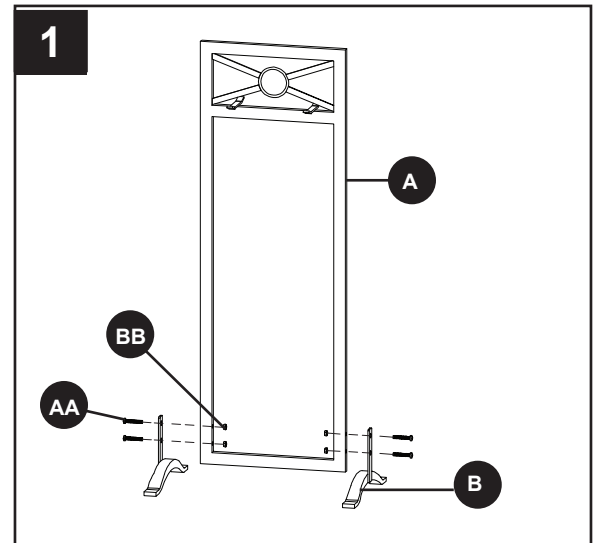

ENTRETIEN

- Essuyez les outils et le support avec un linge.
- N'utilisez pas des produits nettoyants abrasifs pouvant ternir ou rouiller les pièces.
- Rangez-les dans un endroit propre et sec.

1 AN DE GARANTIE LIMITÉE DE FRAME

Si cet article présente des défauts de matériaux ou de fabrication au cours de la première année suivant la date d'achat initiale, nous le réparerons ou le remplacerons à notre discrétion, sans frais. Pour commander des pièces ou effectuer une réclamation au titre de la garantie, composez le 877 447-4768, du lundi au vendredi de 8 h 30 à 16 h 30 (HNC), du lundi au vendredi. Cette garantie ne couvre pas les défauts résultant d'un usage inadéquat, anormal ou inapproprié, d'un accident ou d'une modification. Si vous n'observez pas toutes les instructions contenues dans le guide d'utilisation, cette garantie sera invalide. Le fabricant n'est pas responsable des dommages accessoires ou consécutifs. Certains États ou certaines provinces ne permettent pas l'exclusion ou la limitation des dommages accessoires ou consécutifs, de sorte que la limitation ou l'exclusion des dommages accessoires ou consécutifs mentionnées ci-dessus peuvent ne pas s'appliquer à vous. Cette garantie vous confère des droits précis. Il est possible que vous disposiez également d'autres droits, qui varient d'un État ou d'une province à l'autre.

LISTA DE PIEZAS DE REPUESTO

Para obtener piezas de repuesto, llame a nuestro Departamento de Servicio al Cliente al 1-877-447-4768, de lunes a viernes de 8:30 a.m. a 4:30 p.m., hora central estándar.

PIEZA	DESCRIPCIÓN	PIEZA #
A	Frame	40-01-141
B	Base du porte-outils	40-01-142
C	Tissonier	40-04-413
D	Tongs	40-02-257
E	Brosse	40-06-615
F	Pelle	40-03-368
HWP	Quincaillerie	40-09-504
N/A	Manuel d'instructions	40-10-232

