



OWNER'S MANUAL

Pro-At-Home

Pet Dryer + Vacuum

Model: B-2 (115V/60Hz)

XPOWER MANUFACTURE, INC.
220 Clary Avenue
San Gabriel, CA 91776, USA
Tel: 626-285-3301 Fax: 626-285-3302
www.xpower.ws

Nozzles included

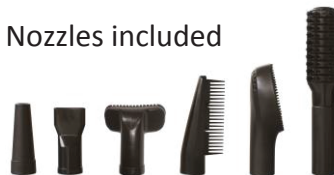

READ AND SAVE THESE INSTRUCTIONS

TABLE OF CONTENTS

| | |
|---------------------------|------|
| Introduction | 1 |
| Safety Instructions | 2-3 |
| Dryer Operation | 4 |
| Vacuum Operation | 5 |
| Specifications | 6-7 |
| Parts List | 8 |
| Maintenance | 9-10 |
| Warranty / Service | 11 |

INTRODUCTION

Thank you for purchasing the B-2 Pro-At-Home Pet Dryer from XPOWER! A trusted name in professional pet grooming, XPOWER is now bringing our professional technology to your home. Extremely powerful and easy to use, you can give your pet that professional salon appearance while saving time and money. The B-2 offers a rugged housing for durability and is engineered for quiet operation. It includes six different styling nozzles and is equipped with two drying speeds to handle a range of different pet coats.

The B-2 also multifunction's as a forced air dryer to clean computers, car interiors, and any other small crevices with ease.

Features:

- 2-in-1 (Pet Dryer + Vacuum).
- Powerful and Energy Efficient.
- Super Lightweight and Compact.
- 2-Speed Control Switch.
- 6 Styling Nozzles (Included).
- 2 Washable 3 Piece Filter Sets.
- 6 ft (1.3" Dia) Flexible Hose.
- Durable ABS Housing.
- Thermally Protected.
- ETL/C-ETL Certified.
- 1 Year Limited Warranty.

IMPORTANT SAFETY INSTRUCTIONS

WARNING: IMPORTANT SAFETY PRECAUTIONS! PLEASE READ COMPLETELY BEFORE USING PRODUCT!

When using electrical appliances, especially when children or animals are present, basic safety precautions should always be followed to reduce the risk of fire, electric shock, and personal injury, including, but not limited to the following:

1. Do not use attachments not intended for use with the dryer. Only use attachments recommended or sold by the manufacturer.
2. Do not attempt to perform any service or maintenance not outlined in instruction manual.
3. Do not use outdoors.
4. **WARNING:** This Pet Dryer is not intended for use by children. Adult assembly and operation required. To reduce the risk of injury, close supervision is necessary when an appliance is used near children.
5. Do not use as a toy.
6. Do not leave appliance when plugged in. Unplug from outlet when not in use and before servicing.
7. Do not use extension cords with dryer.
8. Do not unplug unit by pulling on cord, to unplug, grasp the plug, not the cord.

9. **WARNING:** Never use dryer with a damaged cord or plug, or after the appliance malfunctions or is dropped, damaged, return to an Authorized Service Center for service, examination, repair, or electrical or mechanical adjustment.
10. To disconnect, turn all controls to the off (“O”) position, then remove plug from outlet.
11. Do not pull or carry by cord, use cord as a handle, close a door on cord, or pull cord around sharp edges or corners. Do not run appliance over cord. Keep cord away from heated surfaces.
12. Do not handle plug or appliance with wet hands.
13. Use extra care when cleaning on stairs.
14. **DANGER:** Do not expose dryer to rain or water.
15. Do not use or store dryer where it can fall or be pulled into tub or sink or standing water. If dryer falls into water unplug it, do not reach into the water. Keep units out of baths and do not operate on a wet floor, or wet surface.
16. Do not use to pick up flammable or combustible liquids, such as gasoline, or use in areas where they may be present. Do not pick up anything that is burning or smoking, such as cigarettes, matches, or hot ashes.
17. Unplug before connecting the round groomer rake, flat groomer rake, flat nozzle, cone nozzle and hose.
18. **WARNING:** Do not put any object into dryer openings. Keep loose clothing, jewelry and hair away from dryer openings. Do not use with any opening blocked; keep free of dust, lint, and anything that may reduce air flow.
19. **WARNING:** Do not allow any material to clog or block air intakes as this may cause units to overheat and result in a fire or electrical hazard. Regularly clear hair or other substances from air intakes. Do not contact moving parts.

DRYER OPERATION

1. Place the dryer on a flat surface. Plug the electrical cord into a GFCI outlet.
2. Screw the hose on clockwise to connect to the front hose connector (Fig. A). Attach the desired nozzle. Keep the inlet filter and crossed cover in place on the rear cover. Turn on switch to desired speed.
3. All units in use must be monitored at all times.



Hose Connected to Front

DRYING TIPS

- Before washing, use pet dryer with the cone nozzle to blow out dirt and loose fur from the top coat and undercoat. Brush pet thoroughly and separate matted fur.
- After washing, thoroughly towel dry pet to remove excess water. Use the dryer with desired nozzle to blow off excess water from the large areas of the body (torso, back, hind area).
- Use detail nozzles for smaller areas (underarms, feet, neck area). Be extremely careful not to direct airflow to the pet's eyes, ears or nose.

VACUUM OPERATION

1. Unscrew the hose from the front connector.
2. Remove outer inlet filter and crossed cover of the rear cover (Fig. B).
3. Connect the hose to the rear cover connector (Fig. C) and attach square nozzle.
4. ALWAYS keep air bleed intake hole on the hose open when vacuuming in order to prevent overheating motor (Fig. D).
5. IMPORTANT! Cleaning Dryer Dust Case, Rear Cover and Filters is required BEFORE converting unit back to dryer. See maintenance section for complete cleaning instructions. Serious damage to the motor can occur in drying mode if clean filters and dust case are not in place.

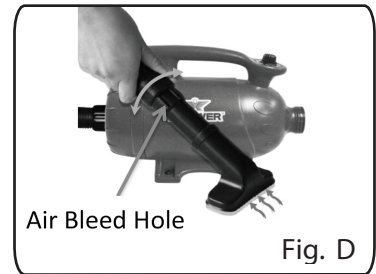
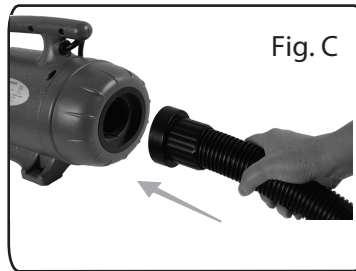

- **Important:** Always keep air bleed hole on the hose open when vacuuming in order to prevent overheating of the motor. This hole is usually closed when drying.

SPECIFICATIONS

| | |
|-------------------------------|-------------------|
| Model | B-2 |
| Volt/Cycle | 115V / 60Hz |
| Horse Power | 2 HP |
| Amps | 8A |
| Unit Weight | 7.6 lbs |
| Speeds (Low/Hi) | 18,000/22,000 RPM |
| Size (L x W x H) | 13" x 6" x 9" |
| Cord Length | 10 ft |
| Hose Length | 6 ft (1.3" Dia) |
| Overheating Protection | Thermal |
| Max. Airflow | 100 CFM |
| Housing Material | ABS |
| Safety Certification | ETL/C-ETL |

Nozzles included



| | | | |
|---|---------------|---|--------------------|
| 1 | Cone Nozzle | 4 | Vented Comb Nozzle |
| 2 | Flat Nozzle | 5 | Curry Nozzle |
| 3 | Square Nozzle | 6 | Brush Nozzle |

SAVE THESE INSTRUCTIONS

HOUSEHOLD and COMMERCIAL USE

SERVICING OF DOUBLE-INSULATED APPLIANCES

A double-insulated appliance is marked with one or more of the following:
The words “DOUBLE INSULATION” or “DOUBLE INSULATED” or the double insulation symbol (square within a square)

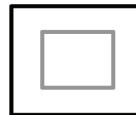

In a double-insulated appliance, two systems of insulation are provided instead of grounding. No grounding means is provided on a double-insulated appliance. Nor should a means for grounding be added to the appliance. Servicing a double-insulated appliance requires extreme care and knowledge of the system, and should be done only by qualified service personnel. Replacement parts for a double-insulated appliance must be identical to the parts they replace.

To reduce the risk of electric shock, this appliance has a polarized plug (one blade is wider than the other). This plug will fit in a polarized outlet only one way. If the plug does not fit fully in the outlet, reverse the plug. If it still does not fit, contact a qualified electrician to install the proper outlet. Do not change the plug in any way.

PARTS LIST

| | | | | | |
|---|---------------------|----|---------------------|----|------------------|
| 1 | Left housing | 7 | Brush | 13 | Dust case filter |
| 2 | Right housing | 8 | Motor | 14 | Rear cover |
| 3 | Switch | 9 | Motor rubber sleeve | 15 | Crossed cover |
| 4 | Air outlet grid | 10 | Dustproof cover | 16 | Inlet filter |
| 5 | Motor rubber sleeve | 11 | Motor filter | | |
| 6 | Hose | 12 | Dust case | | |

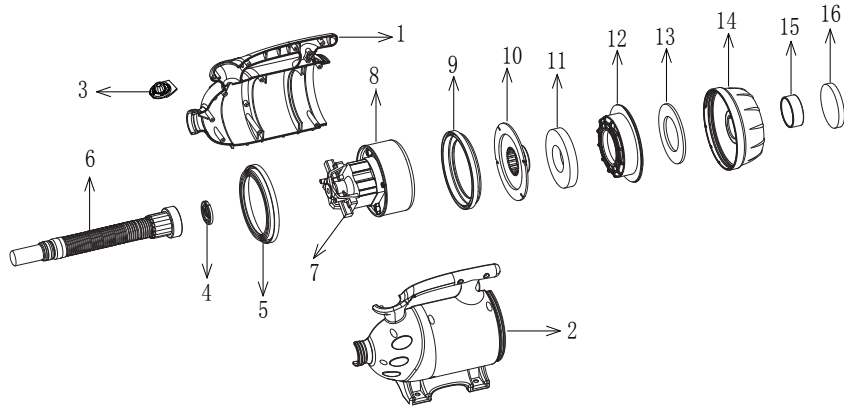

MAINTENANCE

IMPORTANT!

Always turn off the unit and disconnect from electrical outlet before cleaning.

Product Maintenance:

1. To keep the Pet Dryer + Vacuum clean, use a damp cloth to wipe the surface of the housing. Removable part(s) and filters may be cleaned with water and dried thoroughly before reassembling.
2. When not in use, unplug and store the Pet Dryer + Vacuum in a dry indoor place and keep out of reach of children.
3. Always disconnect the Pet Dryer + Vacuum from its power source before performing any maintenance or cleaning.

Cleaning Dryer Dust Case, Rear Cover and Filters:

The Filter System for the XPOWER Pet Dryer + Vacuum (including dust case, rear cover and filters) should be kept clean regularly. If the dust case is full of hair and/or dirt or the filters become heavily coated, the air output and input of your Dryer + Vacuum will reduce and this may cause damage to the motors or cause the motors to overheat. You should never operate the dryer without filters in place. Make sure filters are dry before using them. Rotate with the included extra filters to make sure you always have clean and dry filters available.

Vacuum & Filter Maintenance

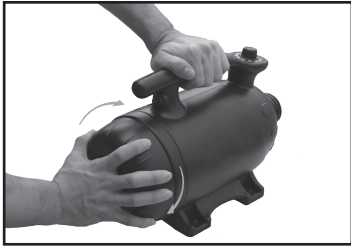

1. Turn the rear cover counter-clockwise to remove the cover.



2. Remove the complete set of dust and rear cover from the unit. Hold the rear cover on top so that the debris remain collected in the dust case.

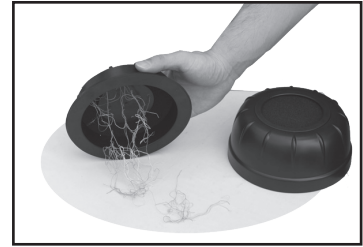

3. Dump the collected debris from the dust case.

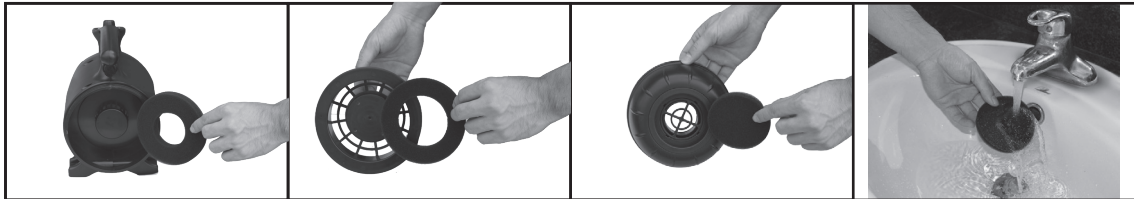

4. Rinse all filters (motor filter, dust case filter, inlet filter) with mild soap and warm water.
5. Reassemble in reverse order when all parts are completely dried.

XPOWER LIMITED WARRANTY

XPOWER Manufacture, Inc. warrants this product to be free from defects in material and workmanship for a period of one (1) year from the date of original purchase. Wearable parts including but without limitation, filters, motor brushes, hoses and power cords are excluded from the warranty. The liability of XPOWER is limited solely to the cost of the repair or replacement of parts/the unit at XPOWER's discretion. This warranty does not cover normal wear of parts and does not apply to any unit that has been tampered with or used for commercial purposes. This limited warranty does not cover damage caused by misuse, abuse, negligent handling or damage due to faulty packaging or mishandling in transit. This warranty does not cover damage or defects caused by or resulting from damages from shipping or repairs, service or alterations to the product or any of its parts, which have been performed by a repair person not authorized by XPOWER.

Limitations and Exclusions

If any part or device manufactured by XPOWER Manufacture, Inc. is repaired or replaced, the new/repaired machine and/or part(s) shall be warrantied only for the remainder of the original warranty period.

SERVICE

For Warranty service and parts replacement (US users only), you must:

- A. Call 1-855-855-8868 for a RMA (Return-Merchandise-Authorization) number.**
- B. Have original proof of purchase.**
- C. Use the original undamaged packaging or an Industrial certified packaging method.**

The end user will be responsible to ship the unit (with RMA Number showing on the shipping label) to the XPOWER Service Department. XPOWER to inspect, assess and advise the repairs needed and the applicable cost, if any.

For users outside the US, please contact XPOWER Distributor in your country or region for Warranty service and parts replacement.

XPOWER PET DRYERS FOR RETAIL GROOMING LINE



Three colors (pink, green and purple) are available for each model.

XPOWER also has a complete professional grooming line, which provides Force Dryers, Stand Dryers, Cage Dryers and Purifying System. Please visit our website XPOWER.WS for more information.

Warranty Registration (for US customer only)

For your product warranty, please complete and mail / fax this form to XPOWER MANUFACTURE, INC.

Address: 220 Clary Ave., San Gabriel, CA 91776. Tel: 626-285-3301 Fax: 626-285-3302

(For your convenience, register your product online at xpower.ws)

Company Name / Contact Person / Title _____

Address _____ City _____

State / Province _____ Zip _____ Country _____

Phone _____ Fax _____ E-mail _____

Model # _____ **Serial #:** _____

Date of Purchase ____/____/____ **Purchased From** _____

Additional Comments / Suggestions _____



From: _____



TO:
XPOWER MANUFACTURE, INC.
220 Clary Avenue
San Gabriel, CA 91776, USA
Tel: 626-285-3301, Fax: 626-285-3302

