

CAROLINA FORGE

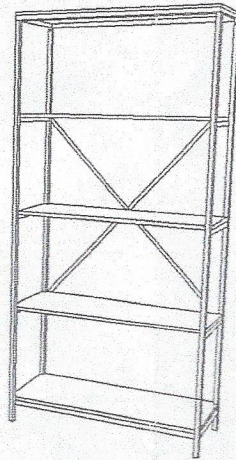







Assembly Instructions Item # CF7234 CARLTON BOOKCASE

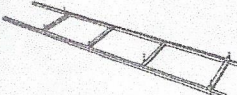
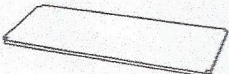





Please Note:
Do not tighten screws completely until bookcase is fully assembled.

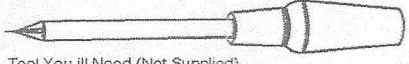

Thank you for purchasing a Carolina Forge Company product. This product has been designed for easy assembly and is constructed for durability. Please take the time to read and follow the assembly instructions carefully. If a part or hardware is missing or you have any difficulties in assembling this product, please contact us Toll Free 1-800-228-3876.

NO.	PART	DESCRIPTION	Q'TY	NO.	PARTS	DESCRIPTION	Q'TY
A		Top	1Pcs	B		Leg	2Pcs
C		Shelf	4Pcs	D		Connecting Tube	2Pcs
E		Cross Brace	1Pcs	F		Bolt 6mm 12mm	8Pcs
G		Allen Head Bolt M5 x 12mm	19Pcs	H		Flat Washer	23Pcs
I		Allen Head Wrench 3mm & 4mm	1Pcs	J		Allen Head Bolt M6 x 10mm	4Pcs
K						Crosshead Screwdriver	
Tool You Will Need (Not Supplied)							

Tip Resistance Kit

L		Wood Screw 30mm	2 PCS	M		Expansion Tube	2 PCS
N		Plastic Fastener 5MM	2 PCS	O		L Bracket	2 PCS

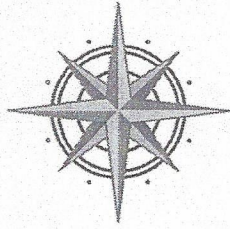

CAROLINA FORGE

Assembly Instructions
Item # CF7234
CARLTON BOOKCASE

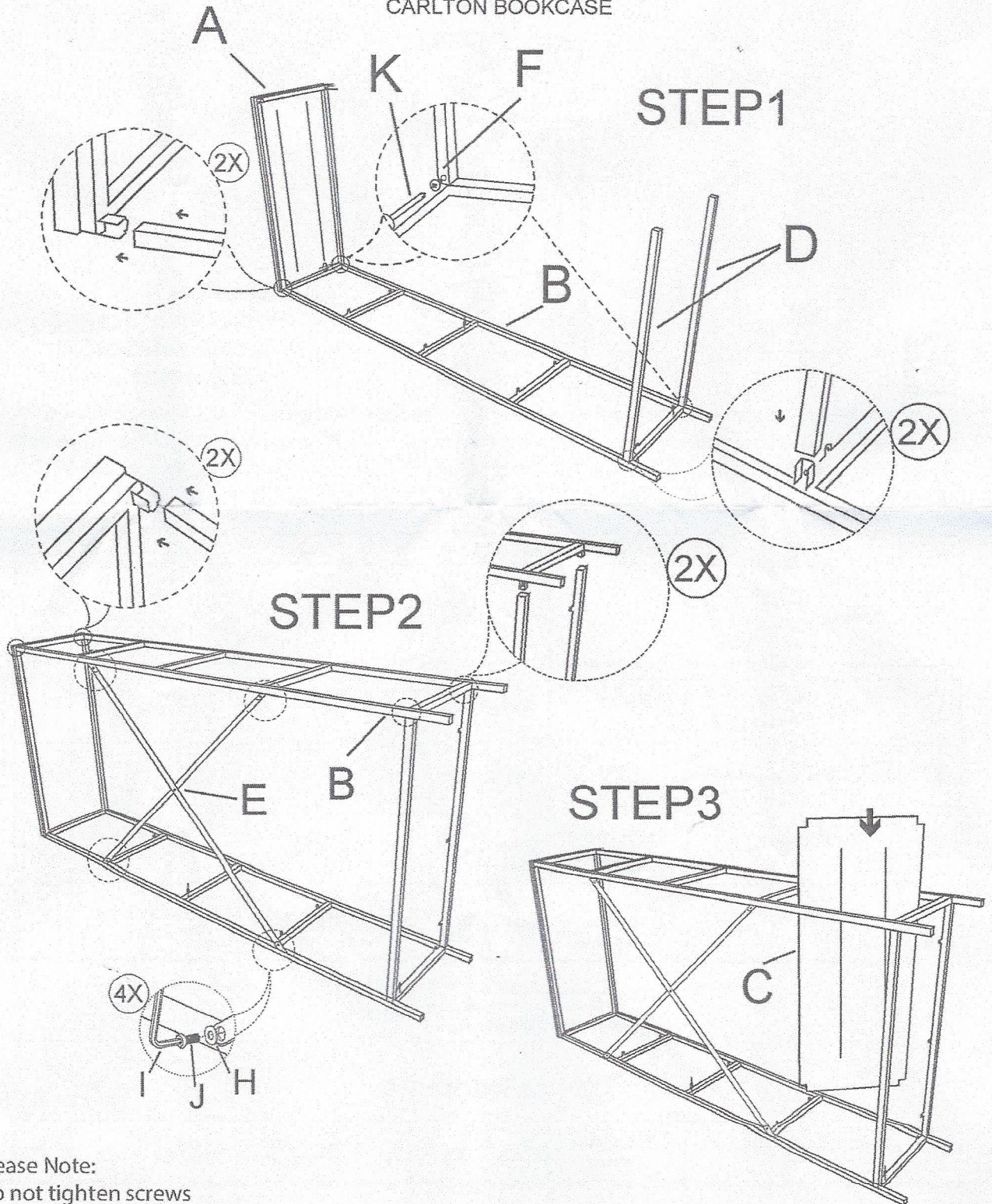

Please Note:
Do not tighten screws
completely until bookcase is
fully assembled.

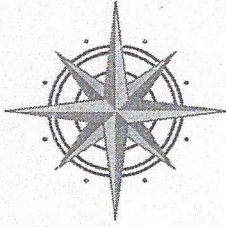

CAROLINA FORGE

Assembly Instructions
Item # CF7234
CARLTON BOOKCASE

STEP 4

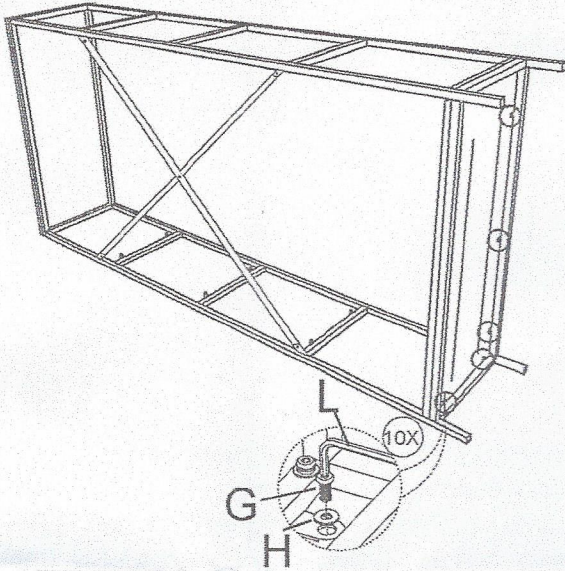

STEP 5

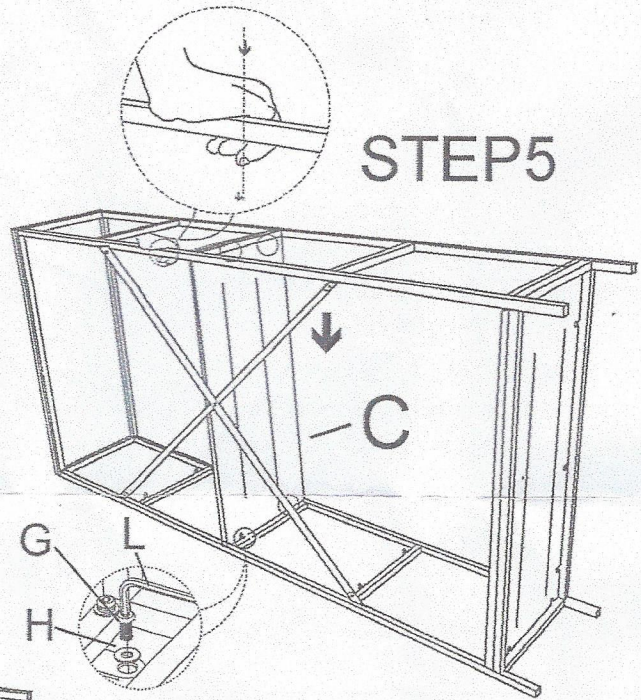

STEP 6

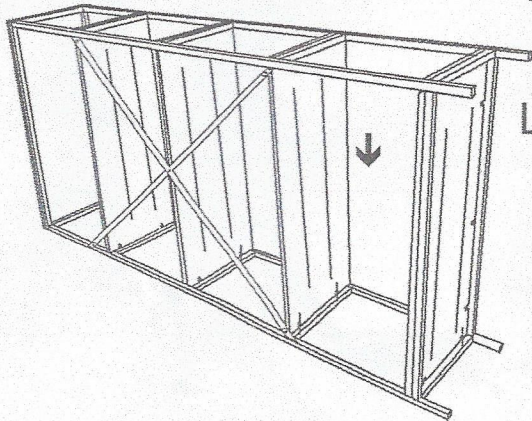

STEP 7

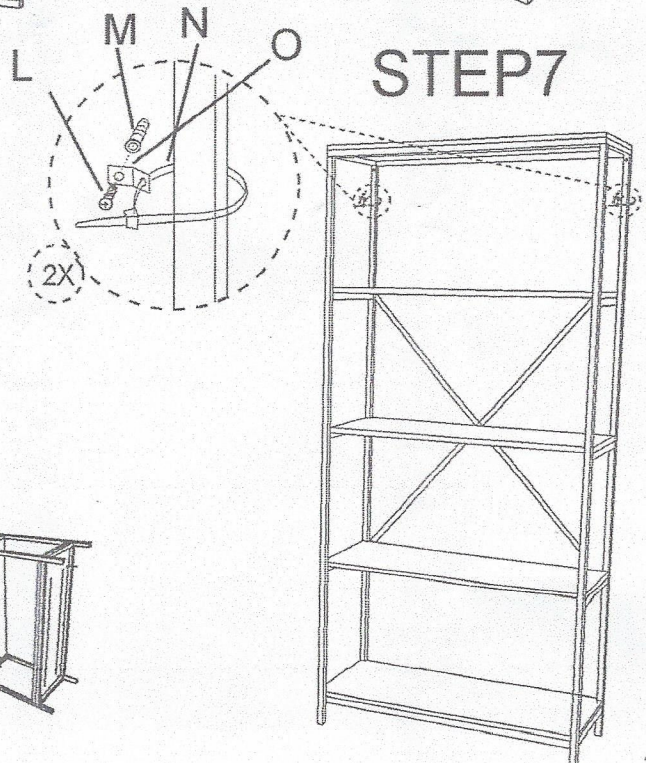

Please Note:
Do not tighten screws
completely until bookcase is
fully assembled.