

Fabric

Pages CL-1 to CL-37

Pipe and Tube

Pages CL-38 to CL-81

Fittings

Pages CL-82 to CL-119

Accessories

Pages CL-120 to CL-129

Gate Fittings

Pages CL-130 to CL-172

Gates

Pages CL-173 to CL-216



Check List

Find all of the products in sections:

- A** Fabric
- B** Pipe and Tube
- C** Fittings
- D** Accessories

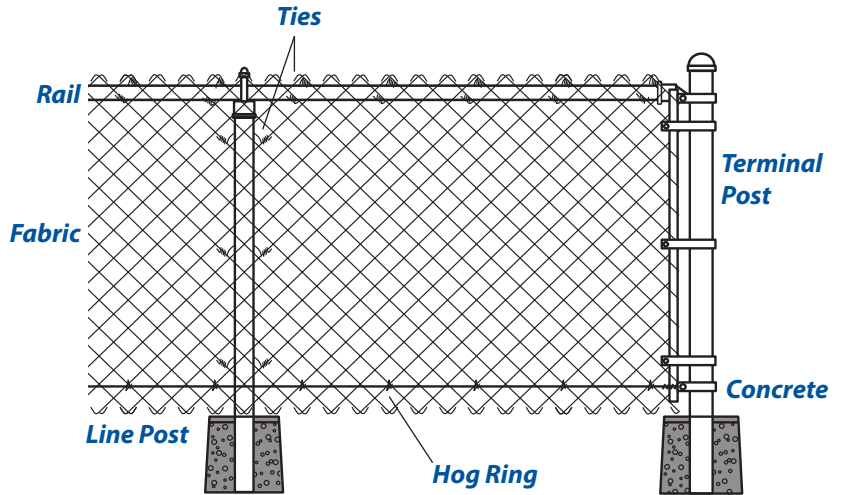

Fence - Fabric, Line Post

Fabric

Same length as fence, minus gate openings.

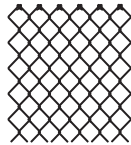

A

Rail

Same length as fabric.

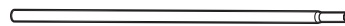

B

Line Post

Space line posts equally, maximum 10' span.



B

Bottom Tension Wire (Optional)

Same length as fence, minus gate openings.



D

Sleeve

Use to join Plain End top rails.



C

Eye Top

1 for each line post.



C

Hog Rings (Optional)

Clips tension wire to fabric, 1 for every 24".

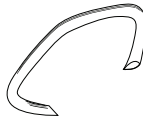

D

Ties

Connects top rail to fabric, 1 for every 24" of top rail.



C

Ties

Connects line post to fabric, 1 for every 12" of line post.



C

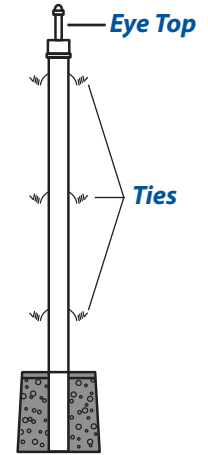

Fence - Terminal Post

Terminal Post

Larger diameter for end, corner posts, pull posts.

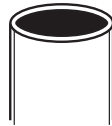

B

Tension Band

Secures tension bar/fabric to posts. Use 1 for each foot in height.

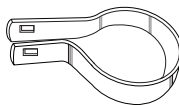

C

Brace Band

1 for each rail end. 1 for each tension wire connection.



C

Carriage Bolt

1 for each tension band. 1 for each brace band.



D

Post Cap

1 for each terminal post.

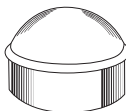

C

Rail End

1 for each terminal post. 2 for each corner post.

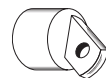

C

Tension Bar

1 for each end post. 2 for each corner post.



C

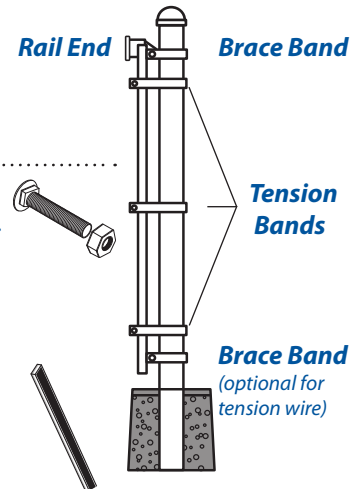

TOOLS

CONCRETE, TAPE MEASURE, STRING & STAKES, POST HOLE DIGGER, WHEELBARROW, SHOVEL, CARPENTER'S LEVEL, PIPE CUTTER, FENCE STRETCHER, HAND WINCH, PLIERS, HOG RING PLIERS

Fence - Add Barb Wire

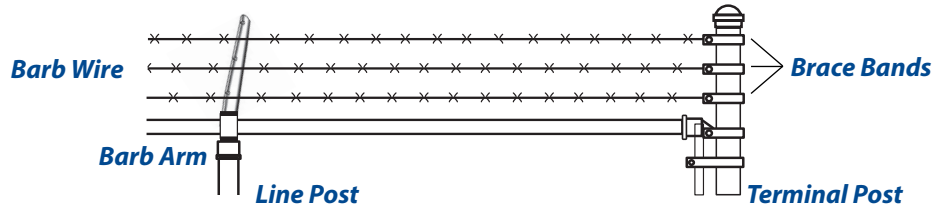
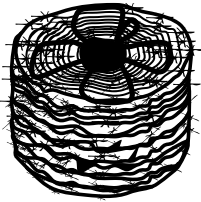

Barb Wire
Same length as fence.



Barb Arm
1 for each line post.
Replaces eye tops.



Brace Band
1 for each rail end.
1 for each barb wire connection.



Carriage Bolt
1 for each brace band.

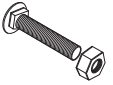

D

C

C

D

Fence - Add Middle Rail or Bottom Rail

Rail

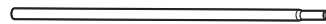

Same length as fence, minus gate openings.

B

Option 1 for Line Posts

180° Brace Band
1 for each line post.



Carriage Bolt
2 for each 180° brace band.

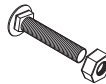

C

D

Rail End

1 for each terminal post.
2 for each line or corner post.



C

Option 2 for Line Posts

Line Rail Clamp
1 for each line post.



Carriage Bolt
2 for each line rail clamp.



C

D

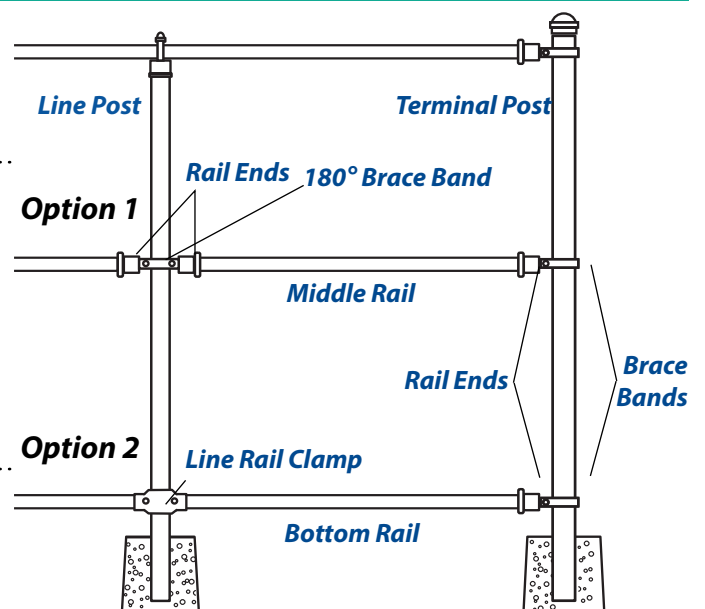

Fence - Add Brace and Truss

Rail

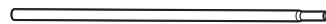

Length from term post to line post

B

Truss Rod

1 for each end post.
2 for each corner post.

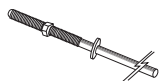

C

Truss Tightener
1 for each truss rod.



C

Truss Rail End
1 for each truss rod.



C

Brace Band
1 for each rail end.



C

Rail End
1 for each terminal post.



C

Carriage Bolt
1 for each brace band.



D

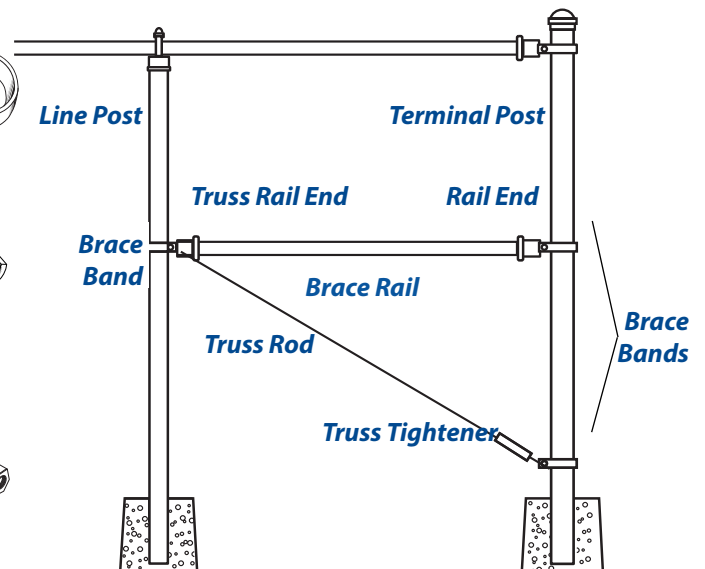

Chain link fabric (a.k.a. “wire”) is manufactured by Master Halco at several US locations.

Selvage describes how the ends of the chain link wires are finished for the top and bottom of the fabric. Knuckle means that the ends of the wires are folded over each other. Twist means the wires are twisted together to form pointed prongs. Residential fabric uses larger mesh sizes and smaller gauges, and commercial/industrial uses smaller mesh sizes and larger gauge diameters. The smallest mesh sizes, from 1-1/4” to 3/8”, are High Security/Mini-Mesh.

Galvanized Before Weaving (GBW)

In this process, the wire is pre-galvanized before it is formed into a fabric. The weaving process creates an exposed cut end that will lack coating and be more apt to some minor rust in wet and severe weather conditions.

Galvanized After Weaving (GAW)

This process forms or weaves chain-link into a fabric first, and then soaks it in a large galvanized bath which adheres the zinc coating. This ensures that all the wire is coated, even the cut ends created during the weaving process.

Aluminized

Aluminum coated steel chain link fence fabric is made by cold drawing good commercial grade steel rod into wire of the appropriate diameter. The steel rod from which the wire is drawn is produced by the open hearth, electric furnace or basic oxygen process. The coating process consists of passing the cleaned wire through a molten bath of aluminum metal.

Selvage

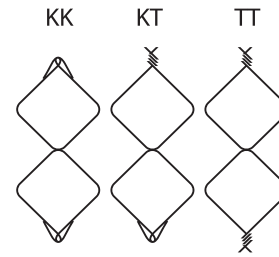

Galvanized & Aluminized Wire Gauges

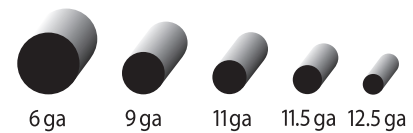

Available Mesh Sizes

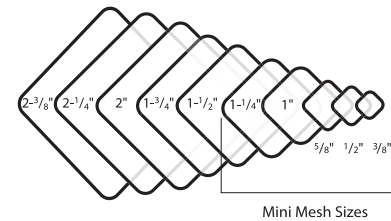

Process	Coating	Gauge	Diameter	Class	ASTM
GBW	0.80 oz	11-1/2	0.113"	Class 3	A 817 Type II
	1.2 oz	11-1/2	0.113"	Class 1	A 392
	1.2 oz	11	0.120"	Class 1	A 392
	1.2 oz	9	0.148"	Class 1	A 392
GAW	1.2 oz	11-1/2	0.113"	N/A	N/A
	1.2 oz	11-1/2	0.113"	Class 1	N/A
	1.2 oz	11	0.120"	Class 1	A 392
	1.2 oz	9	0.148"	Class 1	A 392
	2.0 oz	9	0.148"	Class 2	A 392
	1.2 oz	6	0.192"	Class 1	A 392
	2.0 oz	6	0.192"	Class 2	A 392
Aluminized	0.30 oz	11-1/2	0.113"	N/A	A 491 Type I
	0.40 oz	9	0.148"	N/A	A 491 Type I
	0.40 oz	6	0.192"	N/A	A 491 Type I

Spectra

The galvanized steel core wire for producing extruded PVC coated steel chain link fence fabric is produced by cold-drawing good commercial grade steel rod into wire of the appropriate diameter. The steel rod from which the wire is drawn is produced by the open hearth, electric furnace or basic oxygen process. The galvanized coating is produced by passing the cleaned wire through a bath of molten zinc which conforms to ASTM B6. The extruded PVC coating is produced by extruding PVC at a coating thickness of 0.015" (.38mm) - 0.025" (0.64 mm) over a galvanized core wire.

Spectra Bond

Extruded bonded vinyl is a better alternative to simple extruded wire. With extruded bonded wire, the extruding process is taken one step further: an adhesive is applied to the wire before being extruded with the vinyl coating. This seals the vinyl to the wire to bond provides greater protection against nature.

Permafused

Fused and Adhered vinyl coating. Coated using a polyolefin coating, the galvanized wire is first heated, then coated, causing the wire and the plastic to bond together, creating a better protective coating to prevent moisture from penetrating to the steel core of the wire.

Spectra and Spectra Bond Finish Gauges



Permafused Finish Gauges

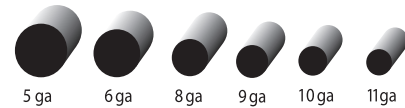

Available Mesh Sizes

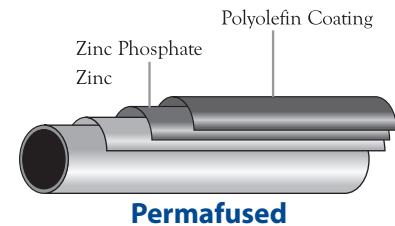
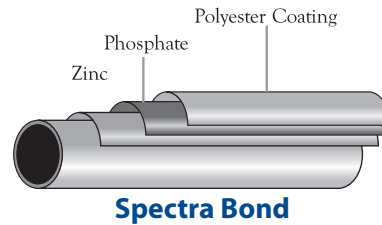
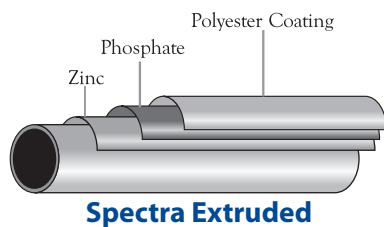
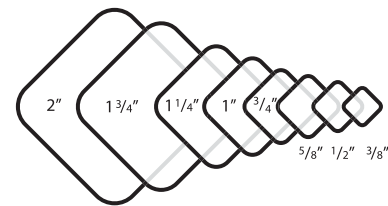

Brand / Process	Wire ASTM	Galv Coating	Core Gauge*	Finish Gauge*	Type	ASTM
Spectra / Extruded	A 641	0.30	9	6	Class 1	F668
	Non-ASTM	0.15	11	8	Class 1	N/A
	Non-ASTM	0.15	13	9	Class 1	N/A
	Non-ASTM	0.15	14	11	Class 1	N/A
Spectra Bond / Extruded Bonded	A 641	0.30	9	6	Class 2a	F668
	A 641	0.30	11	8	Class 2a	F668
	A 641	0.30	12	9	Class 2a	F668
	A 641	0.25	14	11	Class 2a	F668
Permafused / Fuse Bonded	A 641	0.40	6	5	Class 2b	F668
	A 641	0.30	7	6	Class 2b	F668
	A 641	0.30	9	8	Class 2b	F668
	A 641	0.30	10	9	Class 2b	F668
	A 641	0.30	11	10	Class 2b	F668
	A 641	0.30	12	11	Class 2b	F668

* Use the **bolded gauge** (core or finish) for ordering.

Galvanized Before Weaving (GBW)

2-3/8" – 11-1/2 Gauge (0.113") GBW / .80 oz./Ft.² Zinc Coating

Meets ASTM A817 Type II Class 3 • Feet Per Roll: 50

HEIGHT	KK PART NO.	KT PART NO.	WEIGHT PER FT.	NOTES
3'	055479	—	1.09	
42"	055478	—	1.28	
4'	055484	—	1.47	
5'	055485	—	1.83	
6'	055487	055486	2.20	

2-1/4" – 11-1/2 Gauge (0.113") GBW / 1.2 oz./Ft.² Zinc Coating

Meets ASTM A 392, Class 1 • Feet Per Roll: 50

HEIGHT	KK PART NO.	KT PART NO.	WEIGHT PER FT.	NOTES
4'	055587	—	1.60	
5'	055588	—	1.99	
6'	055589	055590	2.40	

Extra charge for broken rolls.

SELVAGE ABBREVIATIONS:

KT - Knuckle-Twist, also known as BK - Barb-Knuckle

TT - Twist-Twist, also known as BB - Barb-Barb

KK - Knuckle-Knuckle

SPECIAL NOTE: KT or TT Selvage on 5' high fabric or less is **not recommended** for Residential Applications

2" – 11 Gauge (0.120") GBW / 1.2 oz./ft.² Zinc Coating

Meets ASTM A 392, Class 1 • Feet Per Roll: 50

HEIGHT	KK PART NO.	KT PART NO.	WEIGHT PER FT.	NOTES
3'	055607	—	1.45	
42"	055608	—	1.70	
4'	055609	—	1.95	
5'	055610	—	2.45	
6'	055611	055612	2.80	
7'	055614	055615	3.40	
8'	055617	055618	3.80	
10'	055620	055621	4.85	
12'	055623	055624	5.80	

2" – 9 Gauge (0.148") GBW / 1.2 oz./ft.² Zinc Coating

Meets ASTM A 392, Class 1 • Feet Per Roll: 50

HEIGHT	KK PART NO.	KT PART NO.	WEIGHT PER FT.	NOTES
3'	055630	—	2.15	
42"	055631	—	2.51	
4'	055632	—	2.90	
5'	055633	—	3.60	
6'	055635	055636	4.30	
7'	055638	055639	5.05	
8'	055641	055642	5.80	
10'	055644	055645	7.20	
12'	055647	055648	8.70	

SPECIAL NOTE: KT or TT Selvage on 5' high fabric or less is **not recommended** for Residential Applications

Hot Dip Galvanized After Weaving (GAW)

2-3/8" – 11-1/2 Gauge (0.113") GAW / 1.2 oz./ft.² Zinc Coating

Meets ASTM A 392, Class 1 • Feet Per Roll: 50

HEIGHT	KK PART NO.	KT PART NO.	WEIGHT PER FT.	NOTES
3'	056202	—	1.13	
42"	056203	—	1.31	
4'	056204	—	1.49	
5'	056205	—	1.85	
6'	056219	056206	2.25	
7'	056220	056207	2.65	
8'	056221	056208	2.98	

2-1/4" – 11-1/2 Gauge (0.113") GAW / 1.2 oz./ft.² Zinc Coating

Meets ASTM A 392, Class 1 • Feet Per Roll: 50

HEIGHT	KK PART NO.	KT PART NO.	WEIGHT PER FT.	NOTES
3'	056102	—	1.19	
42"	056103	—	1.39	
4'	056104	—	1.58	
5'	056105	—	1.97	
6'	056139	056106	2.37	
7'	056177	056167	2.81	
8'	056168	056138	3.20	

Extra charge for broken rolls.

SELVAGE ABBREVIATIONS:

KT - Knuckle-Twist, also known as BK - Barb-Knuckle

TT - Twist-Twist, also known as BB - Barb-Barb

KK - Knuckle-Knuckle

SPECIAL NOTE: KT or TT Selvage on 5' high fabric or less is **not recommended** for Residential Applications

2" – 11 Gauge (0.120") GAW / 1.2 oz./ft.² Zinc Coating

Meets ASTM A 392, Class 1 • Feet Per Roll: 50

HEIGHT	KK PART NO.	KT PART NO.	TT PART NO.	WEIGHT PER FT.	NOTES
3'	054402	—	—	1.45	
42"	054403	—	—	1.69	
4'	054404	—	—	1.93	
5'	054405	—	—	2.41	
6'	054417	054406	054434	2.95	
7'	054436	054407	054437	3.44	
8'	054439	054408	054440	3.93	
10'	054420	054410	054442	4.92	
12'	054444	054412	054445	5.90	

2" – 9 Gauge (0.148") GAW / 1.2 oz./ft.² Zinc Coating

Meets ASTM A 392, Class 1 • Feet Per Roll: 50

HEIGHT	KK PART NO.	KT PART NO.	TT PART NO.	WEIGHT PER FT.	NOTES
3'	055402	—	—	2.18	
42"	055403	—	—	2.50	
4'	055404	—	—	2.87	
5'	055405	—	—	3.59	
6'	055417	055406	055446	4.30	
7'	055461	055460	055407	5.02	
8'	055463	055464	055408	5.78	
9'	055409	055411	055413	6.46	
10'	055410	055466	055467	7.18	
12'	055412	055469	055470	8.61	

2" – 9 Gauge (0.148") GAW / 1.2 oz./ft.² Zinc Coating

Meets ASTM A 392, Class 1 • Feet Per Roll: 100

HEIGHT	KK PART NO.	KT PART NO.	TT PART NO.	WEIGHT PER FT.	NOTES
4'	055380	—	—	2.87	
5'	055381	—	—	3.59	
6'	056411	056410	055382	4.30	
7'	055383	055384	055385	5.02	
8'	055386	055387	055388	5.78	
10'	007460	N00547	—	7.18	
12'	—	—	N01133	8.41	

SPECIAL NOTE: KT or TT Selvage on 5' high fabric or less is **not recommended** for Residential Applications

Hot Dip Galvanized After Weaving (GAW)

2" - 9 Gauge (0.148") GAW / 2.0 oz./ft.² Zinc Coating

Meets ASTM A 392, Class 2 • Feet Per Roll: 50

HEIGHT	KK PART NO.	KT PART NO.	TT PART NO.	WEIGHT PER FT.	NOTES
3'	055422	055433	055434	2.23	
42"	055423	055435	055436	2.61	
4'	055424	055437	055438	2.98	
5'	055425	055439	055440	3.71	
6'	055426	055441	055442	4.46	
7'	055427	055443	055444	5.20	
8'	055428	055445	055447	5.95	
9'	055429	055559	055551	6.69	
10'	055430	055553	055554	7.44	
12'	055432	055555	055556	8.92	

2" - 9 Gauge (0.148") GAW / 2.0 oz./ft.² Zinc Coating

Meets ASTM A 392, Class 2 • Feet Per Roll: 100

HEIGHT	KK PART NO.	KT PART NO.	TT PART NO.	WEIGHT PER FT.	NOTES
4'	190J00	—	—	2.98	
5'	055453	—	—	3.71	
6'	055389	055390	055391	4.46	
7'	055392	055393	055394	5.20	
8'	055395	055396	055397	5.95	
10'	—	466C00	055398	7.44	

Extra charge for broken rolls.

SELVAGE ABBREVIATIONS:

KT - Knuckle-Twist, also known as BK - Barb-Knuckle

TT - Twist-Twist, also known as BB - Barb-Barb

KK - Knuckle-Knuckle

SPECIAL NOTE: KT or TT Selvage on 5' high fabric or less is **not recommended** for Residential Applications

2" – 6 Gauge (0.192") GAW / 1.2 oz./ft.² Zinc Coating

Meets ASTM A 392, Class 1 • Feet Per Roll: 25

HEIGHT	KK PART NO.	KT PART NO.	TT PART NO.	WEIGHT PER FT.	NOTES
3'	055302	—	—	3.83	
42"	055303	—	—	4.46	
4'	055304	—	—	5.12	
5'	055305	—	—	6.38	
6'	055340	055306	055341	7.65	
7'	055342	055343	055307	8.93	
8'	055344	055345	055308	10.20	
9'	055346	055347	055309	11.48	
10'	055310	055348	055349	12.75	
12'	055312	055350	055351	15.30	

2" – 6 Gauge (0.192") GAW / 2.0 oz./ft.² Zinc Coating

Meets ASTM A 392, Class 2 • Feet Per Roll: 25

HEIGHT	KK PART NO.	KT PART NO.	TT PART NO.	WEIGHT PER FT.	NOTES
3'	—	—	—	3.85	
4'	055321	—	—	5.15	
5'	055374	—	—	6.41	
6'	055314	055352	055326	7.71	
7'	005023	055318	055327	8.98	
8'	055320	055353	055328	10.28	
9'	055346	055347	055309	11.32	
10'	055376	057259	055330	12.82	
12'	055378	055313	055331	15.38	

Extra charge for broken rolls.

SELVAGE ABBREVIATIONS:

KT - Knuckle-Twist, also known as BK - Barb-Knuckle

TT - Twist-Twist, also known as BB - Barb-Barb

KK - Knuckle-Knuckle

SPECIAL NOTE: KT or TT Selvage on 5' high fabric or less is **not recommended** for Residential Applications

Hot Dip Galvanized After Weaving (GAW)

1-3/4" - 11 Gauge (0.120") GAW / 1.2 oz./ft.² Zinc Coating

Meets ASTM A 392, Class 1 • Feet Per Roll: 50

HEIGHT	KK PART NO.	WEIGHT PER FT.	NOTES
10'	054310	5.65	
12'	054312	6.78	

1-3/4" - 9 Gauge (0.148") GAW / 1.2 oz./ft.² Zinc Coating

Meets ASTM A 392, Class 1 • Feet Per Roll: 50

HEIGHT	KK PART NO.	WEIGHT PER FT.	NOTES
10'	054320	8.48	
12'	054322	10.18	

Extra charge for broken rolls.

SELVAGE ABBREVIATIONS:

KK - Knuckle-Knuckle

SPECIAL NOTE: KT or TT Selvage on 5' high fabric or less is **not recommended** for Residential Applications

2-1/4" – 11-1/2 Gauge (0.113") Aluminized / .30 oz./ft.² Aluminum Coating

Meets ASTM A 491 • Feet Per Roll: 50

HEIGHT	KK PART NO.	KT PART NO.	TT PART NO.	WEIGHT PER FT.	NOTES
3'	057052	—	—	1.20	
42"	057053	—	—	1.40	
4'	057054	—	—	1.60	
5'	057055	—	—	2.00	
6'	057057	057056	—	2.40	

2" – 9 Gauge (0.148") Aluminized / .40 oz./ft.² Aluminum Coating

Meets ASTM A 491 • Feet Per Roll: 50

HEIGHT	KK PART NO.	KT PART NO.	TT PART NO.	WEIGHT PER FT.	NOTES
3'	057202	—	—	2.00	
42"	057203	—	—	2.33	
4'	057204	—	—	2.67	
5'	057205	—	—	3.33	
6'	057214	057206	057213	4.00	
7'	057216	057207	057215	4.67	
8'	057218	057208	057217	5.33	
10'	057210	057219	057220	6.67	
12'	057212	057221	057222	8.00	

Extra charge for broken rolls.

SELVAGE ABBREVIATIONS:

KT - Knuckle-Twist, also known as BK - Barb-Knuckle

TT - Twist-Twist, also known as BB - Barb-Barb

KK - Knuckle-Knuckle

SPECIAL NOTE: KT or TT Selvage on 5' high fabric or less is **not recommended** for Residential Applications

Aluminized

2" – 6 Gauge (0.192") Aluminized / .40 oz./ft.² Aluminum Coating

Meets ASTM A 491 • Feet Per Roll: 50

HEIGHT	KK PART NO.	KT PART NO.	TT PART NO.	WEIGHT PER FT.	NOTES
4'	057236	—	—	4.74	
5'	057239	—	—	5.93	
6'	057242	057243	057244	7.12	
7'	057245	057246	057247	8.30	
8'	057248	057249	057250	8.30	
10'	057251	057252	057253	11.86	
12'	057254	057255	057256	14.23	

1-3/4" – 11 Gauge (0.120") Aluminized / .35 oz./ft.² Aluminum

Meets ASTM A 491 • Feet Per Roll: 50

HEIGHT	KK PART NO.	WEIGHT PER FT.	NOTES
10'	057110	5.20	
12'	057112	6.24	

Extra charge for broken rolls.

SELVAGE ABBREVIATIONS:

KT - Knuckle-Twist, also known as BK - Barb-Knuckle

TT - Twist-Twist, also known as BB - Barb-Barb

KK - Knuckle-Knuckle

SPECIAL NOTE: KT or TT Selvage on 5' high fabric or less is **not recommended** for Residential Applications

2" – 13 Gauge Core / 9 Gauge Finish Spectra® (Extruded PVC)

Feet Per Roll: 50

HEIGHT	KK PART NO.	KT PART NO.	TT PART NO.	WEIGHT PER FT.	NOTES
3'	51314_	—	—	1.08	
42"	51315_	—	—	1.26	
4'	51316_	—	—	1.44	
5'	51317_	—	—	1.80	
6'	51318_	51358_	51368_	2.16	
7'	51319_	51359_	—	2.52	
8'	51320_	51360_	51370_	2.90	
10'	51322_	51362_	—	3.60	
12'	51324_	51515_	—	4.35	

2" – 11 Gauge Core / 8 Gauge Finish Spectra® (Extruded PVC)

Feet Per Roll: 50

HEIGHT	KK PART NO.	KT PART NO.	WEIGHT PER FT.	NOTES
3'	51482_	—	1.08	
42"	51484_	—	1.26	
4'	51486_	—	1.44	
5'	51488_	—	1.80	
6'	51490_	51491_	2.16	
7'	51492_	—	2.52	
8'	51494_	51495_	2.90	
10'	51496_	—	3.60	
12'	51498_	—	4.35	

Spectra®

- Other selvages available on special order.
- Other sizes and colors available on special quotation.
- Setup charges may apply for quantities less than 300 feet of non-stock items. Please inquire at your local branch.

- Add the following number to the part no. for desired color:

1-Forest Green 2-Midnight Black 3-Sierra Brown

Extra charge for broken rolls.

SELVAGE ABBREVIATIONS:

KT - Knuckle-Twist, also known as BK - Barb-Knuckle

TT - Twist-Twist, also known as BB - Barb-Barb

KK - Knuckle-Knuckle

SPECIAL NOTE: KT or TT Selvage on 5' high fabric or less is **not recommended** for Residential Applications

2" – 9 Gauge Core / 6 Gauge Finish Spectra® (Extruded PVC)

Feet Per Roll: 50

HEIGHT	KK PART NO.	KT PART NO.	TT PART NO.	WEIGHT PER FT.	NOTES
3'	51302_	—	—	1.61	
42"	51303_	—	—	1.87	
4'	51304_	—	—	2.14	
5'	51305_	—	—	2.68	
6'	51306_	51297_	51289_	3.21	
7'	51307_	51298_	51290_	3.57	
8'	51308_	51299_	51291_	4.28	
10'	51310_	51300_	—	5.35	
12'	51312_	—	—	6.42	

1-3/4" – 13 Gauge Core / 9 Gauge Finish Spectra® (Extruded PVC)

HEIGHT	KK PART NO. 30' ROLL	KK PART NO. 50' ROLL	WEIGHT PER FT.	NOTES
4'		51330_	1.72	
5'		51331_	2.15	
6'		51332_	2.58	
7'		51337_	3.01	
8'		51333_	3.44	
10'	51338_	51340_	4.30	
12'	51339_	51342_	5.16	

1-3/4" – 11 Gauge Core / 8 Gauge Finish Spectra® (Extruded PVC)

Feet Per Roll: 50

HEIGHT	KK PART NO.	WEIGHT PER FT.	NOTES
10'	51480_	5.92	

Add the following number to the part no. for desired color:
1-Forest Green 2-Midnight Black 3-Sierra Brown

Extra charge for broken rolls.

SELVAGE ABBREVIATIONS:

KT - Knuckle-Twist, also known as BK - Barb-Knuckle

TT - Twist-Twist, also known as BB - Barb-Barb

KK - Knuckle-Knuckle

SPECIAL NOTE: KT or TT Selvage on 5' high fabric or less is **not recommended** for Residential Applications

2" – 11 Gauge Core / 8 Gauge Finish Spectra Bond® (Extruded Bonded PVC)

Meets ASTM F 668, Class 2a • Feet Per Roll: 50

HEIGHT	KK PART NO.	KT PART NO.	WEIGHT PER FT.	NOTES
6'	48433_	48434_	3.12	
7'	48435_	48436_	3.64	
8'	48437_	48438_	4.16	

2" – 9 Gauge Core / 6 Gauge Finish Spectra Bond® (Extruded Bonded PVC)

Meets ASTM F 668, Class 2a • Feet Per Roll: 25

HEIGHT	KK PART NO.	KT PART NO.	WEIGHT PER FT.	NOTES
3'	48410_	—	2.43	
42"	48411_	—	2.84	
4'	48412_	—	3.24	
5'	48413_	—	4.05	
6'	48400_	48405_	4.50	
7'	48401_	48406_	5.25	
8'	48402_	48407_	6.00	
10'	48403_	—	7.50	
12'	48404_	—	9.00	

1-3/4" – 11 Gauge Core / 8 Gauge Finish Spectra Bond® (Extruded Bonded PVC)

Meets ASTM F 668, Class 2a • Feet Per Roll: 50

HEIGHT	KK PART NO.	WEIGHT PER FT.	NOTES
10'	48439_	6.04	
12'	48440_	7.25	

1-3/4" – 9 Gauge Core / 6 Gauge Finish Spectra Bond® (Extruded Bonded PVC)

Meets ASTM F 668, Class 2a • Feet Per Roll: 25

HEIGHT	KK PART NO.	WEIGHT PER FT.	NOTES
10'	48408_	9.00	
12'	48409_	10.84	

Add the following number to the part no. for desired color:

1-Forest Green 2-Midnight Black 3-Sierra Brown

SPECIAL NOTE: KT or TT Selvage on 5' high fabric or less is **not recommended** for Residential Applications

Permafused

2" – 9 Gauge Core / 8 Gauge Finish Permafused (Fused and Adhered)

Meets ASTM F 668, Class 2b • Feet Per Roll: 25 or 50

HEIGHT	KK PART NO.	KT PART NO.	WEIGHT PER FT.	NOTES
3'	48598_	—	2.25	
42"	48599_	—	2.63	
4'	48600_	—	3.00	
5'	48601_	—	3.75	
6'	48602_	48608_	4.50	
7'	48603_	48609_	5.25	
8'	48604_	48610_	6.00	
10'	48605_	48611_	7.50	
12'	48606_	48607_	9.00	

1-Forest Green, 25' roll 2-Midnight Black, 25' roll 3-Sierra Brown, 25' roll
 5-Forest Green, 50' roll 6-Midnight Black, 50' roll 9-Sierra Brown, 50' roll

Only applies to 2" - 9 Gauge Core / 8 Gauge Finished Permafused

1-3/4" – 9 Gauge Core / 8 Gauge Finish Permafused (Fused and Ahered)

Meets ASTM F 668, Class 2b • Feet Per Roll: 25

HEIGHT	KK PART NO.	WEIGHT PER FT.	NOTES
10'	48613_	9.00	
12'	48612_	10.84	

Permafused

- Other selvages available on special order.
- Other sizes and colors available on special quotation.
- Setup charges my apply for quantities less than 300 feet of non-stock items. Please inquire at your local branch.

- Add the following number to the part no. for desired color:

1-Forest Green 2-Midnight Black 3-Sierra Brown

Extra charge for broken rolls.

SELVAGE ABBREVIATIONS:

KT - Knuckle-Twist, also known as BK - Barb-Knuckle

TT - Twist-Twist, also known as BB - Barb-Barb

KK - Knuckle-Knuckle

SPECIAL NOTE: KT or TT Selvage on 5' high fabric or less is **not recommended** for Residential Applications

Slat Master® 80% Privacy - 9 Gauge GBW - Stapled

Plastic Slats, Galvanized Chain Link Fabric
 3-1/2" x 5" Mesh, 1.20 oz./ft.² Zinc Coating
 2-3/8" Polyethylene Slats

• Feet Per Roll: 25

Add the following number to the part number for the desired slat color:

0 - Tan 1 - Green 2 - Black 3 - Brown 4 - White 5 - Gray 6 - Redwood 7 - Sky Blue

HEIGHT	KK PART NO.	PT PART NO.	WEIGHT PER FT.	NOTES
4'	51010_	50501_	3.10	
5'	51011_	50502_	3.87	
6'	51012_	50503_	4.81	
7'	51013_	50504_	5.55	
8'	51014_	50505_	6.18	
10'	51015_	50506_	7.74	
12'	51016_	50507_	9.61	

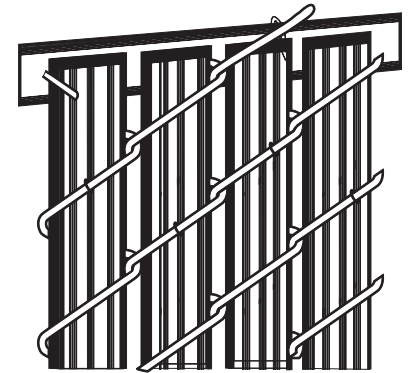

Slat Master® 95% Privacy - 9 Gauge GBW

Plastic Slats, Galvanized Chain Link Fabric
 3-1/2" x 5" Mesh, 1.20 oz./ft.² Zinc Coating
 2-13/16" Polyethylene Slats

• Feet Per Roll: 25

Add the following number to the part number for the desired slat color:

0 - Tan 1 - Green 2 - Black 3 - Brown 4 - White 5 - Gray 6 - Redwood 7 - Sky Blue

HEIGHT	KK PART NO.	PT PART NO.	WEIGHT PER FT.	NOTES
5'	51021_	—	3.90	
6'	51022_	50508_	4.68	
7'	51023_	50514_	5.50	
8'	51024_	50515_	6.28	
10'	51025_	—	7.33	
12'	51026_	—	9.17	

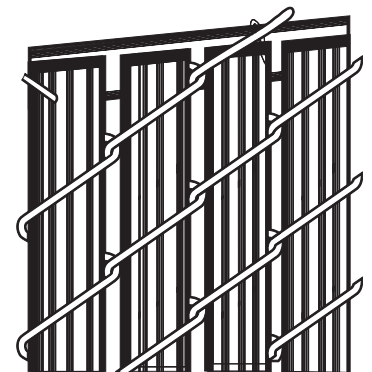

Available in full rolls only.

Setup charges may apply for quantities less than 300' for non-stock items. Please inquire at your local branch.

SELVAGE ABBREVIATIONS:

KK - Knuckle-Knuckle

PT - Pig Tail

Slat Master®

Slat Master® 95% Privacy - PermaFused 9 Gauge Core / 8 Gauge Finish

Plastic Slats, Fused & Adhered Chain Link Fabric

3-1/2" x 5" Mesh

Coating 2-13/16" Polyethylene Slats

• Feet Per Roll: 25

Other colors are available: Inquire at your local branch.

SELVAGE: KK

SLAT COLOR / FABRIC COLOR

HEIGHT	GREEN/GREEN	BLACK/BLACK	BROWN/BROWN	WEIGHT PER FT.	NOTES
3'	—	N00764	—	2.34	
4'	—	N00765	—	3.12	
5'	—	510282	510283	3.90	
6'	—	510272	510273	4.86	

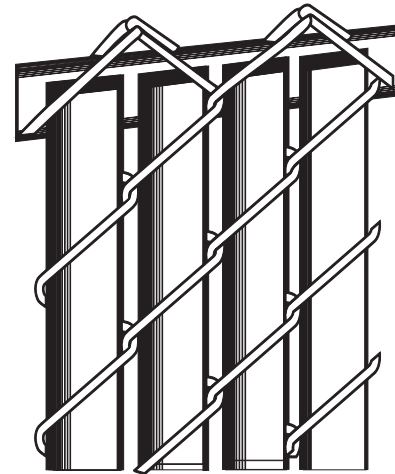

SELVAGE: PT

SLAT COLOR / FABRIC COLOR

HEIGHT	GREEN/GREEN	BLACK/BLACK	BROWN/BROWN	WEIGHT PER FT.	NOTES
4'	—	175P00	312D00	3.10	
5'	—	—	823V00	3.87	
6'	—	—	504993	4.81	
7'	—	504792	—	5.55	
8'	504781	504782	—	6.18	
10'	—	504852	—	7.74	

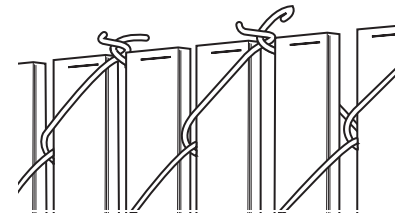

Available in full rolls only.

Setup charges may apply for quantities less than 300' for non-stock items. Please inquire at your local branch.

SELVAGE ABBREVIATIONS:

KK - Knuckle-Knuckle

PT - Pig Tail

Slat Master® 80% Privacy - Stapled - 9 Gauge Core / 8 Gauge Finish

Plastic Slats, Fused & Adhered Chain Link

3-1/2" x 5" Mesh

2-3/8" Polyethylene Slats

• Feet Per Roll: 25

Other colors are available: Inquire at your local branch.

SELVAGE: KK

SLAT COLOR / FABRIC COLOR

HEIGHT	BLACK/BLACK	WEIGHT PER FT.	NOTES
5'	510302	3.87	
6'	302J00	4.81	
7'	510612	5.55	
8'	510291	6.18	
10'	510292	7.74	

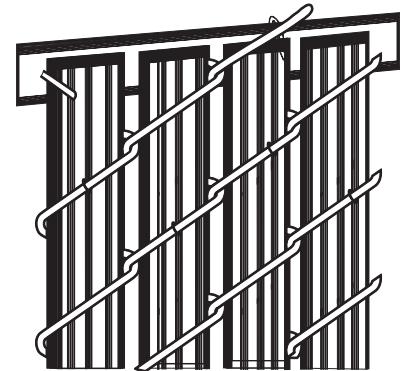

SELVAGE: PT

SLAT COLOR / FABRIC COLOR

HEIGHT	GREEN/GREEN	BLACK/BLACK	BROWN/BROWN	WEIGHT PER FT.	NOTES
4'	—	207O00	—	4.10	
5'	881T00	—	—	4.25	
6'	505001	505002	505003	5.00	
7'	214Y00	—	—	5.55	
8'	504881	351L00	N00714	8.20	
12'	215Y00	—	—	9.61	

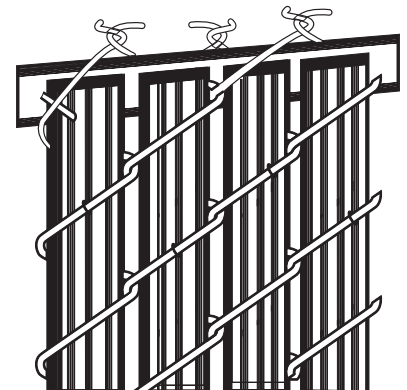

Available in full rolls only.

Setup charges may apply for quantities less than 300' for non-stock items. Please inquire at your local branch.

SELVAGE ABBREVIATIONS:

KK - Knuckle-Knuckle

PT - Pig Tail

Slat Master® 95% Privacy - 10 Gauge GBW

Plastic Slats, Galvanized Chain Link
 3-1/2" x 5" Mesh, 1.2 oz./ft.² Zinc Coating
 2-13/16" Polyethylene Slats

• Feet Per Roll: 25

SELVAGE: KK

HEIGHT	TAN	GREEN	BLACK	BROWN	WHITE	GREY	REDWOOD	SKY BLUE	WEIGHT PER FT.	NOTES
3'	505120	505121	—	—	505120	505125	505126	—	2.40	
4'	505130	505131	—	—	—	—	505136	—	3.10	
5'	505220	500V00	—	—	—	—	—	—	3.87	
6'	505110	505111	—	505113	505114	505115	505116	—	4.81	
7'	505180	467W00	—	505193	505184	—	505186	—	5.55	
8'	—	—	—	—	505234	506V00	—	628V00	6.07	

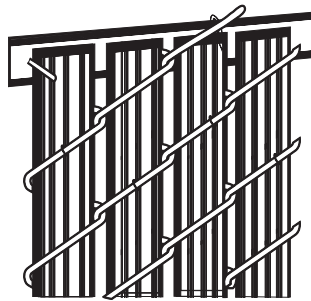

Slat Master® 95% Privacy - PermaFused 10 Gauge Core / 9 Gauge Finish

Plastic Slats, Fused & Adhered Chain Link Fabric

3-1/2" x 5" Mesh

2-13/16" Polyethylene Slats

• Feet Per Roll: 25

SELVAGE: KK

SLAT COLOR / FABRIC COLOR

HEIGHT	TAN/TAN	GREEN/GREEN	BLACK/BLACK	BROWN/BROWN	REDWOOD/REDWOOD	WEIGHT PER FT.	NOTES
3'	—	—	—	505243	832X00	3.10	
4'	502000	—	—	505133	—	3.87	
6'	—	505203	301J00	505183	505206	4.81	
7'	962X00	—	—	234Y00	—	5.55	
8'	—	—	—	007687	—	6.18	

Available in full rolls only.

Setup charges may apply for quantities less than 300' for non-stock items. Please inquire at your local branch.

SELVAGE ABBREVIATIONS:

KK - Knuckle-Knuckle

Slat Master® 80% Privacy - Replacement Slats

Plastic Slats

2-3/8" High Density Polyethylene Slats

• 90 pieces per bag. Approximate coverage per bag: 18 linear feet.

HEIGHT	TAN	GREEN	BLACK	BROWN	REDWOOD	WEIGHT EA.	NOTES
4'	—	203811	—	203813	203816	0.24	
5'	—	203821	203822	203823	203826	0.30	
6'	203830	203831	203832	203833	203836	0.36	
7'	—	—	—	203843	—	0.47	
8'	203850	203851	203852	203853	203856	0.48	
10'	203860	203861	203862	203863	203866	0.67	

Slat Master® 95% Privacy - Replacement Slats

Plastic Slats

2-13/16" High Density Polyethylene Slats

• 106 pieces per bag. Approximate coverage per bag: 25 linear feet.

HEIGHT	TAN	GREEN	BLACK	BROWN	REDWOOD	WEIGHT EA.	NOTES
4'	204680	—	—	204683	—	0.27	
5'	204690	204691	—	204693	204696	0.33	
6'	204700	204701	204702	204703	204706	0.40	
7'	—	—	—	204713	204716	0.47	
8'	204720	204721	—	204723	204726	0.54	

Special heights available upon request.

Chain Link Slats

Bottom-Locking Slats / High Density Polyethelene (HDPE)

•ADD THE FOLLOWING NUMBER TO THE PART NUMBER FOR DESIRED COLOR:

0-Beige 1-Green 2-Black 3-Brown 4-White 5-Gray 6-Redwood 7-Sky Blue

Note: Only sold in full bags.

Packaging will be in plastic bags.

Privacy - Approximately 75%

SLAT TYPE	SLAT WIDTH	MESH SIZE	WIRE GAUGE	SLATS PER BAG	APPROX COVERAGE PER BAG
2" Slat	1-3/32"	2"	8, 9, or 11	82	10 linear feet
2 1/4" Slat	1-1/4"	2-1/4 or 2-3/8"	11-1/2 or 12-1/2"	78	10 linear feet
1 3/4" Slat	7/8"	1-3/4"	8, 9, or 11	100	10 linear feet
1 3/4" Slat	7/8"	2"	6	100	10 linear feet

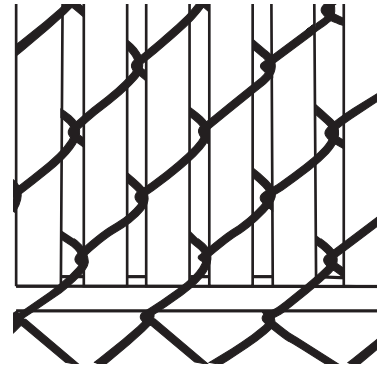

DESCRIPTION	PART NO. 2" SLAT	PART NO. 2-1/4" SLAT	WEIGHT PER PKG.	NOTES
3' Fence Height	20280_	20369_	8.00	
42" Fence Height	20281_	20370_	10.00	
4' Fence Height	20282_	20371_	11.00	
5' Fence Height	20283_	20372_	14.00	
6' Fence Height	20284_	20373_	17.00	
7' Fence Height	20285_	20374_	20.00	
8' Fence Height	20286_	20375_	23.00	
10' Fence Height	20288_	20377_	29.00	
12' Fence Height	20289_	20379_	35.00	

Bottom Channel / High Density Polyethelene (HDPE)

ADD THE FOLLOWING NUMBER TO THE PART NUMBER FOR DESIRED COLOR:

0-Beige 1-Green 2-Black 3-Brown 4-White 5-Gray 6-Redwood

DESCRIPTION	PART NO.	PER PALLET	WEIGHT EA.	NOTES
40" Length	20155_	50	0.50	

All special and non-stock items will be shipped collect — F.O.B. Factory

SPECIAL NOTE: KT or TT Selvage on 5' high fabric or less is **not recommended** for Residential Applications

Top-Locking Slats / High Density Polyethelene (HDPE)

ADD THE FOLLOWING NUMBER TO THE PART NUMBER FOR DESIRED COLOR:

0-Beige 1-Green 2-Black 3-Brown 4-White 5-Gray 6-Redwood 7-Sky Blue

Note: Only sold in full bags.

Packaging will be in plastic bags.

Privacy - Approximately 75%

SLAT TYPE	SLAT WIDTH	MESH SIZE	WIRE GAUGE	SLATS PER BAG	APPROX COVERAGE PER BAG
2" Slat	1-3/32"	2"	8, 9, or 11	82	10 linear feet
2 1/4" Slat	1-1/4"	2-1/4 or 2-3/8"	11-1/2 or 12-1/2"	78	10 linear feet
1 3/4" Slat	7/8"	1-3/4"	8, 9, or 11	100	10 linear feet
1 3/4" Slat	7/8"	2"	6	100	10 linear feet

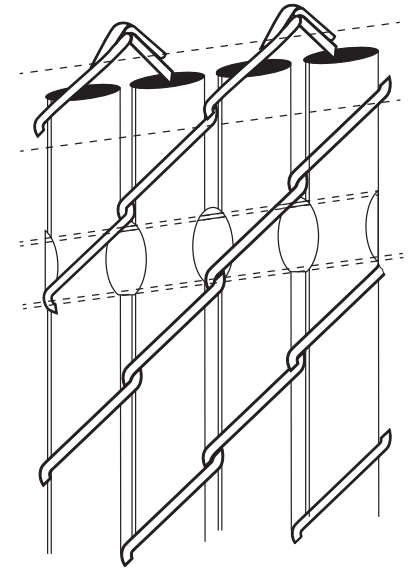

DESCRIPTION	PART NO. 2" SLAT	PART NO. 2-1/4" SLAT	WEIGHT PER PKG.	NOTES
3' Fence Height	20450_	20459_	8.00	
42" Fence Height	20451_	20460_	10.00	
4' Fence Height	20452_	20461_	11.00	
5' Fence Height	20453_	20462_	14.00	
6' Fence Height	20454_	20463_	17.00	
7' Fence Height	20455_	20464_	20.00	
8' Fence Height	20456_	20465_	23.00	
10' Fence Height	20457_	20466_	29.00	
12' Fence Height	20458_	20467_	35.00	

All special and non-stock items will be shipped collect — F.O.B. Factory

SPECIAL NOTE: KT or TT Selvage on 5' high fabric or less is **not recommended** for Residential Applications

Chain Link Slats

Winged Slat® / High Density Polyethylene (HDPE)

ADD THE FOLLOWING NUMBER TO THE PART NUMBER FOR DESIRED COLOR:

0-Beige 1-Green 2-Black 3-Brown 4-White 5-Gray 6-Redwood 7-Sky Blue 8-Navy Blue

Note: Only sold in full bags.

Packaging will be in plastic bags.

Privacy - Approximately 90%

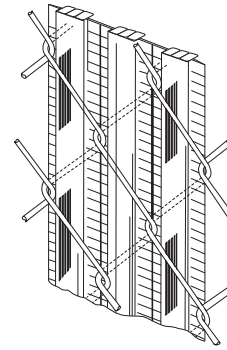

SLAT TYPE	SLAT WIDTH	MESH SIZE	WIRE GAUGE	SLATS PER BAG	APPROX COVERAGE PER BAG
Winged Slat	1-1/4"	2"	9 only	82	10 linear feet

DESCRIPTION	PART NO. 2" MESH	WEIGHT PER PKG.	NOTES
4' Fence Height	19956_	12.00	
5' Fence Height	19957_	15.00	
6' Fence Height	19958_	18.00	
7' Fence Height	19963_	22.00	
8' Fence Height	19959_	25.00	

M - Slat / High Density Polyethylene (HDPE)

ADD THE FOLLOWING NUMBER TO THE PART NUMBER FOR DESIRED COLOR:

0-Beige 1-Green 2-Black 3-Brown 4-White 5-Gray 6-Redwood 7-Sky Blue

Note: Only sold in full bags.

Packaging will be in plastic bags.

Privacy - Approximately 90%

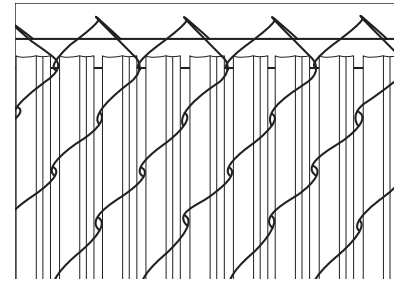

SLAT TYPE	SLAT WIDTH	MESH SIZE	WIRE GAUGE	SLATS PER BAG	APPROX COVERAGE PER BAG
M-Slat	1-1/4"	2", 2 1/4", or 2 3/8"	9, 11, or 11 1/2"	82	10 linear feet

DESCRIPTION	PART NO.	WEIGHT PER PKG.	NOTES
4' Fence Height	20167_	7.2	
5' Fence Height	20166_	9.0	
6' Fence Height	20395_	10.8	
7' Fence Height	20428_	11.0	
8' Fence Height	20429_	14.0	

All special and non-stock items will be shipped collect — F.O.B. Factory

SPECIAL NOTE: KT or TT Selvage on 5' high fabric or less is **not recommended** for Residential Applications

Safety Top Cap / High Density Polyethelene (HDPE)

ADD THE FOLLOWING NUMBER TO THE PART NUMBER FOR DESIRED COLOR:

1- Green 2-Black 9 Safety Yellow

Note: Only sold in full bags, 5 cap sections per bag

- Cap sections are 8' long, 5-1/2" high, 2-3/4" wide
- Coverage per bag: approximately 40 linear feet
- Hog Rings per bag 15

DESCRIPTION	PART NO.	BAG QTY.	WEIGHT PER PKG.	NOTES
8' Safety Top Cap	20430_	5	11.00	

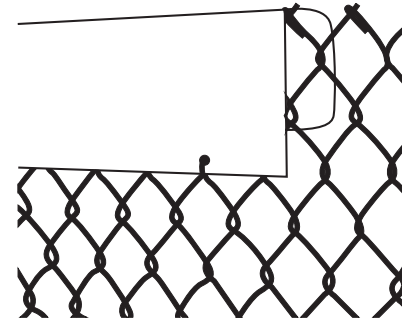

Safety Top Cap - Lite / High Density Polyethelene (HDPE)

Note: Only sold in full bags, 10 cap sections per bag

- Cap sections are 8' long, 4" high, 2-1/2" wide
- Coverage per bag: approximately 80 linear feet

DESCRIPTION	PART NO.	BAG QTY.	WEIGHT PER PKG.	NOTES
8' Safety Top Cap - Yellow	009388	10	11.00	
Zip Ties - Black	274A00	100	2.00	

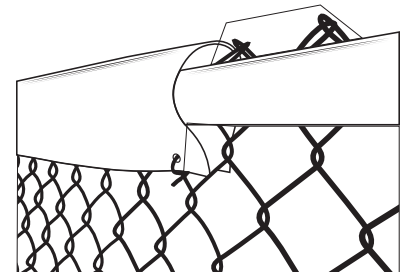

Corrugated Top Cap

DESCRIPTION	PART NO. BLACK	PART NO. YELLOW	WEIGHT PER EA.	NOTES
100' Corrugated	—	002116	27.00	
250' Corrugated	911V00	204319	67.00	
19" Ties	—	953D00	3.00	

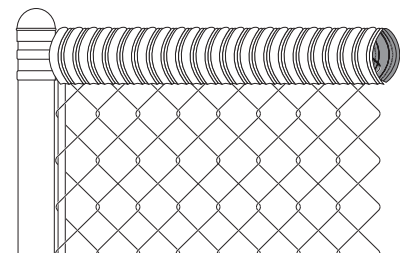

All special and non-stock items will be shipped collect — F.O.B. Factory

SPECIAL NOTE: KT or TT Selvage on 5' high fabric or less is **not recommended** for Residential Applications

High Security and Mini Mesh

9 Gauge (0.148") GBW / 1.2 oz./ft.² Zinc Coating

Meets ASTM A 392, Class 1 • Feet Per Roll: 25 (50 ft for 1-1/4")

HEIGHT	3/8"		1/2"		5/8"	
	KK PART NO.	WEIGHT PER FT.	KK PART NO.	WEIGHT PER FT.	KK PART NO.	WEIGHT PER FT.
3'	MM0009	10.83	MM0099	8.25	MM0189	6.57
42"	MM0019	12.64	MM0109	9.63	MM0199	7.67
4'	MM0029	14.44	MM0119	11.00	MM0209	8.76
5'	MM0039	18.05	MM0129	13.75	MM0219	10.95
6'	MM0049	21.66	MM0139	16.50	MM0229	13.14
7'	MM0059	25.27	MM0149	19.25	MM0239	15.33
8'	MM0069	28.88	MM0159	22.00	MM0249	17.52
10'	MM0079	36.10	MM0169	27.50	MM0259	21.90
12'	MM0089	43.32	MM0179	33.00	MM0269	26.28

HEIGHT	3/4"		1"		1-1/4"	
	KK PART NO.	WEIGHT PER FT.	KK PART NO.	WEIGHT PER FT.	KK PART NO.	WEIGHT PER FT.
3'	MM0279	5.49	MM0369	4.25	MM0459	3.30
42"	MM0289	6.41	MM0379	4.83	MM0469	3.85
4'	MM0299	7.32	MM0389	5.66	MM0479	4.40
5'	MM0309	9.15	MM0399	6.90	MM0489	5.50
6'	MM0319	10.98	MM0409	8.28	MM0499	6.60
7'	MM0329	12.81	MM0419	9.66	MM0509	7.70
8'	MM0339	14.64	MM0429	11.04	MM0519	8.80
10'	MM0349	18.30	MM0439	13.80	MM0529	11.00
12'	MM0359	21.96	MM0449	16.99	MM0539	13.20

Extra charge for broken rolls.

Setup charges may apply for quantities less than 300' for non-stock items. Please inquire at your local branch.

SELVAGE ABBREVIATIONS:

KK - Knuckle-Knuckle

11 Gauge (0.120") GBW / 1.2 oz./ft.² Zinc Coating

Meets ASTM A 392, Class 1 • Feet Per Roll: 25 (50 ft for 1-1/4")

HEIGHT	3/8"		1/2"		5/8"	
	KK PART NO.	WEIGHT PER FT.	KK PART NO.	WEIGHT PER FT.	KK PART NO.	WEIGHT PER FT.
3'	MM1089	8.20	MM1179	6.30	MM1269	4.51
42"	MM1099	9.56	MM1189	7.35	MM1279	5.26
4'	MM1109	10.93	MM1199	8.40	MM1289	6.01
5'	MM1119	13.66	MM1209	10.50	MM1299	7.52
6'	MM1129	16.39	MM1219	12.60	MM1309	9.02
7'	MM1139	19.13	MM1229	14.70	MM1319	10.52
8'	MM1149	21.86	MM1239	16.80	MM1329	12.02
10'	MM1159	27.32	MM1249	21.00	MM1339	15.03
12'	MM1169	32.79	MM1259	25.20	MM1349	18.04

HEIGHT	3/4"		1"		1-1/4"	
	KK PART NO.	WEIGHT PER FT.	KK PART NO.	WEIGHT PER FT.	KK PART NO.	WEIGHT PER FT.
3'	MM1359	3.78	MM1449	2.84	MM1539	2.27
42"	MM1369	4.41	MM1459	3.31	MM1549	2.65
4'	MM1379	5.04	MM1469	3.78	MM1559	3.02
5'	MM1389	6.30	MM1479	4.73	MM1569	3.78
6'	MM1399	7.56	MM1489	5.67	MM1579	4.54
7'	MM1409	8.82	MM1499	6.62	MM1589	5.29
8'	MM1419	10.08	MM1509	7.56	MM1599	6.05
10'	MM1429	12.60	MM1519	9.45	MM1609	7.56
12'	MM1439	15.12	MM1529	11.34	MM1619	9.07

Extra charge for broken rolls.

Setup charges may apply for quantities less than 300' for non-stock items. Please inquire at your local branch.

SELVAGE ABBREVIATIONS:

KK - Knuckle-Knuckle

High Security and Mini Mesh

9 Gauge (0.148") GBW / 2.0 oz./ft.² Zinc Coating

Meets ASTM A 392, Class 2 • Feet Per Roll: 25 (50 ft for 1-1/4")

HEIGHT	3/8"		1/2"		5/8"	
	KK PART NO.	WEIGHT PER FT.	KK PART NO.	WEIGHT PER FT.	KK PART NO.	WEIGHT PER FT.
3'	MM0549	11.52	MM0639	8.76	MM0729	6.96
42"	MM0559	13.44	MM0649	10.22	MM0739	8.12
4'	MM0569	15.36	MM0659	11.68	MM0749	9.28
5'	MM0579	19.20	MM0669	14.60	MM0759	11.60
6'	MM0589	23.04	MM0679	17.52	MM0769	13.92
7'	MM0599	26.88	MM0689	20.44	MM0779	16.24
8'	MM0609	30.72	MM0699	23.36	MM0789	18.56
10'	MM0619	38.40	MM0709	29.20	MM0799	23.20
12'	MM0629	46.08	MM0719	35.04	MM0809	27.84

HEIGHT	3/4"		1"		1-1/4"	
	KK PART NO.	WEIGHT PER FT.	KK PART NO.	WEIGHT PER FT.	KK PART NO.	WEIGHT PER FT.
3'	MM0819	5.85	MM0909	4.38	MM0999	3.51
42"	MM0829	6.83	MM0919	5.11	MM1009	4.10
4'	MM0839	7.80	MM0929	5.84	MM1019	4.68
5'	MM0849	9.75	MM0939	7.30	MM1029	5.85
6'	MM0859	11.70	MM0949	8.76	MM1039	7.02
7'	MM0869	13.65	MM0959	10.22	MM1049	8.19
8'	MM0879	15.60	MM0969	11.68	MM1059	9.36
10'	MM0889	19.50	MM0979	14.60	MM1069	11.70
12'	MM0899	23.40	MM0989	17.52	MM1079	14.04

Extra charge for broken rolls.

Setup charges may apply for quantities less than 300' for non-stock items. Please inquire at your local branch.

SELVAGE ABBREVIATIONS:

KK - Knuckle-Knuckle

11 Gauge (0.120") Aluminized / .35 oz./ft.² Aluminized Coating

Meets ASTM A 491 • Feet Per Roll: 25 (50 ft for 1-1/4")

HEIGHT	3/8"		1/2"		5/8"	
	KK PART NO.	WEIGHT PER FT.	KK PART NO.	WEIGHT PER FT.	KK PART NO.	WEIGHT PER FT.
3'	MM2169	8.14	MM2259	6.18	MM2349	4.90
42"	MM2179	9.49	MM2269	7.21	MM2359	5.72
4'	MM2189	10.85	MM2279	8.24	MM2369	6.53
5'	MM2199	13.56	MM2289	10.30	MM2379	8.17
6'	MM2209	16.28	MM2299	12.36	MM2389	9.80
7'	MM2219	18.99	MM2309	14.41	MM2399	11.43
8'	MM2229	21.70	MM2319	16.47	MM2409	13.07
10'	MM2239	27.13	MM2329	20.59	MM2419	16.34
12'	MM2249	32.55	MM2339	24.71	MM2429	19.60

HEIGHT	3/4"		1"		1-1/4"	
	KK PART NO.	WEIGHT PER FT.	KK PART NO.	WEIGHT PER FT.	KK PART NO.	WEIGHT PER FT.
3'	MM2439	4.13	MM2529	3.12	MM2619	2.19
42"	MM2449	4.82	MM2539	3.64	MM2629	2.55
4'	MM2459	5.50	MM2549	4.16	MM2639	2.92
5'	MM2469	6.88	MM2559	5.20	MM2649	3.65
6'	MM2479	8.26	MM2569	6.24	MM2659	4.38
7'	MM2489	9.63	MM2579	7.28	MM2669	5.11
8'	MM2499	11.01	MM2589	8.32	MM2679	5.84
10'	MM2509	13.76	MM2599	10.40	MM2689	7.30
12'	MM2519	16.51	MM2609	12.48	MM2699	8.76

Extra charge for broken rolls.

Setup charges may apply for quantities less than 300' for non-stock items. Please inquire at your local branch.

SELVAGE ABBREVIATIONS:

KK - Knuckle-Knuckle

High Security and Mini Mesh

9 Gauge (0.148") Aluminized / .40 oz./ft.² Aluminized Coating

Meets ASTM A 491 • Feet Per Roll: 25 (50 ft for 1-1/4")

HEIGHT	3/8"		1/2"		5/8"	
	KK PART NO.	WEIGHT PER FT.	KK PART NO.	WEIGHT PER FT.	KK PART NO.	WEIGHT PER FT.
3'	MM1629	12.65	MM1719	9.62	MM1809	7.63
42"	MM1639	14.76	MM1729	11.23	MM1819	8.91
4'	MM1649	16.87	MM1739	12.83	MM1829	10.18
5'	MM1659	21.09	MM1749	16.04	MM1839	12.72
6'	MM1669	25.30	MM1759	19.25	MM1849	15.27
7'	MM1679	29.52	MM1769	22.45	MM1859	17.81
8'	MM1689	33.74	MM1779	25.66	MM1869	20.35
10'	MM1699	42.17	MM1789	32.08	MM1879	25.44
12'	MM1709	50.61	MM1799	38.49	MM1889	30.53

HEIGHT	3/4"		1"		1-1/4"	
	KK PART NO.	WEIGHT PER FT.	KK PART NO.	WEIGHT PER FT.	KK PART NO.	WEIGHT PER FT.
3'	MM1899	6.50	MM1989	4.86	MM2079	3.86
42"	MM1909	7.59	MM1999	5.67	MM2089	4.50
4'	MM1919	8.67	MM2009	6.48	MM2099	5.15
5'	MM1929	10.84	MM2019	8.10	MM2109	6.44
6'	MM1939	13.01	MM2029	9.72	MM2119	7.72
7'	MM1949	15.18	MM2039	11.34	MM2129	9.01
8'	MM1959	17.34	MM2049	12.96	MM2139	10.30
10'	MM1969	21.68	MM2059	16.20	MM2149	12.87
12'	MM1979	26.02	MM2069	19.44	MM2159	15.44

Extra charge for broken rolls.

Setup charges may apply for quantities less than 300' for non-stock items. Please inquire at your local branch.

SELVAGE ABBREVIATIONS:

KK - Knuckle-Knuckle

11 Gauge Core / 8 Gauge Finish Spectra® (Extruded Bonded PVC)

Meets ASTM A 668, Class 2a • Feet Per Roll: 25 (50 ft for 1-1/4")

HEIGHT	5/8"		3/4"	
	KK PART NO.	WEIGHT PER FT.	KK PART NO.	WEIGHT PER FT.
3'	MM353_	5.38	MM364_	4.53
42"	MM354_	6.28	MM365_	5.28
4'	MM355_	7.17	MM366_	6.04
5'	MM356_	8.97	MM367_	7.55
6'	MM357_	10.76	MM368_	9.06
7'	MM358_	12.55	MM369_	10.56
8'	MM359_	14.35	MM370_	12.07
9'	MM360_	16.14	MM371_	13.58
10'	MM361_	17.93	MM372_	15.09
11'	MM362_	19.73	MM373_	16.60
12'	MM363_	21.52	MM374_	18.11

HEIGHT	1"		1-1/4"	
	KK PART NO.	WEIGHT PER FT.	KK PART NO.	WEIGHT PER FT.
3'	MM375_	3.47	MM386_	2.92
42"	MM376_	4.05	MM387_	3.41
4'	MM377_	4.63	MM388_	3.90
5'	MM378_	5.78	MM389_	4.87
6'	MM379_	6.94	MM390_	5.84
7'	MM380_	8.10	MM391_	6.82
8'	MM381_	9.25	MM392_	7.79
9'	MM382_	10.41	MM393_	8.77
10'	MM383_	11.57	MM394_	9.74
11'	MM384_	12.72	MM395_	10.71
12'	MM385_	13.88	MM396_	11.69

Extra charge for broken rolls.

Setup charges may apply for quantities less than 300' for non-stock items. Please inquire at your local branch.

SELVAGE ABBREVIATIONS:

KK - Knuckle-Knuckle

Add the following number to the part no. for desired color:

1-Forest Green 2-Midnight Black 3-Sierra Brown

High Security and Mini Mesh

9 Gauge Core / 6 Gauge Finish Spectra® (Extruded Bonded PVC)

Meets ASTM F 668, Class 2a • Feet Per Roll: 25 (50 ft for 1-1/4")

HEIGHT	1"		1-1/4"	
	KK PART NO.	WEIGHT PER FT.	KK PART NO.	WEIGHT PER FT.
3'	MM331_	5.52	MM342_	4.25
42"	MM332_	6.44	MM343_	4.96
4'	MM333_	7.36	MM344_	5.67
5'	MM334_	9.20	MM345_	7.09
6'	MM335_	11.04	MM346_	8.51
7'	MM336_	12.88	MM347_	9.92
8'	MM337_	14.72	MM348_	11.34
9'	MM338_	16.56	MM349_	12.76
10'	MM339_	18.40	MM350_	14.18
11'	MM340_	20.24	MM351_	15.59
12'	MM341_	22.08	MM352_	17.01

Extra charge for broken rolls.

Setup charges may apply for quantities less than 300' for non-stock items. Please inquire at your local branch.

SELVAGE ABBREVIATIONS:

KK - Knuckle-Knuckle

Add the following number to the part no. for desired color:

1-Forest Green 2-Midnight Black 3-Sierra Brown

13 Gauge Core / 9 Gauge Finish Spectra® (Extruded PVC)

Class 1 • Feet Per Roll: 25 (50 ft for 1-1/4")

HEIGHT	3/8"		1/2"		5/8"	
	KK PART NO.	WEIGHT PER FT.	KK PART NO.	WEIGHT PER FT.	KK PART NO.	WEIGHT PER FT.
3'	MM198_	5.91	MM209_	4.50	MM221_	3.48
42"	MM199_	6.90	MM210_	5.25	MM222_	4.06
4'	MM200_	7.88	MM211_	6.00	MM223_	4.64
5'	MM201_	9.85	MM213_	7.50	MM224_	5.80
6'	MM202_	11.82	MM214_	9.00	MM225_	6.96
7'	MM203_	13.79	MM215_	10.50	MM226_	8.12
8'	MM204_	15.76	MM216_	12.00	MM227_	9.28
9'	MM205_	17.73	MM217_	13.50	MM228_	10.44
10'	MM206_	19.70	MM218_	15.00	MM229_	11.60
11'	MM207_	21.67	MM219_	16.50	MM230_	12.76
12'	MM208_	23.64	MM220_	18.00	MM231_	13.92

HEIGHT	3/4"		1"		1-1/4"	
	KK PART NO.	WEIGHT PER FT.	KK PART NO.	WEIGHT PER FT.	KK PART NO.	WEIGHT PER FT.
3'	MM232_	3.00	MM243_	2.10	MM254_	1.80
42"	MM233_	3.50	MM244_	2.63	MM255_	2.10
4'	MM234_	4.00	MM245_	2.80	MM256_	2.40
5'	MM235_	5.00	MM246_	3.50	MM257_	3.00
6'	MM236_	6.00	MM247_	4.20	MM258_	3.60
7'	MM237_	7.00	MM248_	4.90	MM259_	4.20
8'	MM238_	8.00	MM249_	5.60	MM260_	4.80
9'	MM239_	9.00	MM250_	6.75	MM261_	5.40
10'	MM240_	10.00	MM251_	7.00	MM262_	6.00
11'	MM241_	11.00	MM252_	8.25	MM263_	6.60
12'	MM242_	12.00	MM253_	8.40	MM264_	7.20

Extra charge for broken rolls.

Setup charges may apply for quantities less than 300' for non-stock items. Please inquire at your local branch.

SELVAGE ABBREVIATIONS:

KK - Knuckle-Knuckle

Add the following number to the part no. for desired color:

1-Forest Green 2-Midnight Black 3-Sierra Brown

High Security and Mini Mesh

14 Gauge Core / 11 Gauge Finish Spectra® (Extruded PVC)

Class 1 • Feet Per Roll: 25 (50 ft for 1-1/4")

HEIGHT	3/8"		1/2"		5/8"	
	KK PART NO.	WEIGHT PER FT.	KK PART NO.	WEIGHT PER FT.	KK PART NO.	WEIGHT PER FT.
3'	MM265_	4.56	MM276_	2.94	MM287_	2.76
42"	MM266_	5.32	MM277_	3.43	MM288_	3.22
4'	MM267_	6.08	MM278_	3.92	MM289_	3.68
5'	MM268_	7.60	MM279_	4.90	MM290_	4.61
6'	MM269_	9.11	MM280_	5.88	MM291_	5.53
7'	MM270_	10.63	MM281_	6.86	MM292_	6.45
8'	MM271_	12.15	MM282_	7.84	MM293_	7.37
9'	MM272_	13.67	MM283_	8.82	MM294_	8.29
10'	MM273_	15.19	MM284_	9.80	MM295_	9.21
11'	MM274_	16.71	MM285_	10.78	MM296_	10.13
12'	MM275_	18.23	MM286_	11.76	MM297_	11.05

HEIGHT	3/4"		1"		1-1/4"	
	KK PART NO.	WEIGHT PER FT.	KK PART NO.	WEIGHT PER FT.	KK PART NO.	WEIGHT PER FT.
3'	MM298_	2.32	MM309_	1.73	MM320_	1.38
42"	MM299_	2.71	MM310_	2.02	MM321_	1.61
4'	MM300_	3.10	MM311_	2.31	MM322_	1.84
5'	MM301_	3.87	MM312_	2.89	MM323_	2.30
6'	MM302_	4.65	MM313_	3.47	MM324_	2.76
7'	MM303_	5.42	MM314_	4.04	MM325_	3.22
8'	MM304_	6.19	MM315_	4.62	MM326_	3.68
9'	MM305_	6.97	MM316_	5.20	MM327_	4.15
10'	MM306_	7.74	MM317_	5.78	MM328_	4.61
11'	MM307_	8.52	MM318_	6.35	MM329_	5.07
12'	MM308_	9.29	MM319_	6.93	MM330_	5.53

Extra charge for broken rolls.

Setup charges may apply for quantities less than 300' for non-stock items. Please inquire at your local branch.

SELVAGE ABBREVIATIONS:

KK - Knuckle-Knuckle

Add the following number to the part no. for desired color:

1-Forest Green 2-Midnight Black 3-Sierra Brown

11 Gauge Core / 8 Gauge Finish Spectra® (Extruded PVC)

Class 1 • Feet Per Roll: 25 (50 ft for 1-1/4")

HEIGHT	3/8"		1/2"		5/8"	
	KK PART NO.	WEIGHT PER FT.	KK PART NO.	WEIGHT PER FT.	KK PART NO.	WEIGHT PER FT.
3'	MM132_	8.94	MM143_	6.79	MM154_	6.03
42"	MM133_	10.43	MM144_	7.92	MM155_	7.04
4'	MM134_	11.92	MM145_	9.06	MM156_	8.04
5'	MM135_	14.90	MM146_	11.32	MM157_	10.05
6'	MM136_	17.88	MM147_	13.58	MM158_	12.06
7'	MM137_	20.85	MM148_	15.85	MM159_	14.07
8'	MM138_	23.83	MM149_	18.11	MM160_	16.08
9'	MM139_	26.81	MM150_	20.37	MM161_	18.09
10'	MM140_	29.79	MM151_	22.64	MM162_	20.10
11'	MM141_	32.77	MM152_	24.90	MM163_	22.11
12'	MM142_	35.75	MM153_	27.17	MM164_	24.12

HEIGHT	3/4"		1"		1-1/4"	
	KK PART NO.	WEIGHT PER FT.	KK PART NO.	WEIGHT PER FT.	KK PART NO.	WEIGHT PER FT.
3'	MM165_	4.53	MM176_	3.47	MM187_	2.92
42"	MM166_	5.28	MM177_	4.05	MM188_	3.41
4'	MM167_	6.04	MM178_	4.63	MM189_	3.90
5'	MM168_	7.55	MM179_	5.78	MM190_	4.87
6'	MM169_	9.06	MM180_	6.94	MM191_	5.84
7'	MM170_	10.56	MM181_	8.10	MM192_	6.82
8'	MM171_	12.07	MM182_	9.25	MM193_	7.79
9'	MM172_	13.58	MM183_	10.41	MM194_	8.77
10'	MM173_	15.09	MM184_	11.57	MM195_	9.74
11'	MM174_	16.60	MM185_	12.72	MM196_	10.71
12'	MM175_	18.11	MM186_	13.88	MM197_	11.69

Extra charge for broken rolls.

Setup charges may apply for quantities less than 300' for non-stock items. Please inquire at your local branch.

SELVAGE ABBREVIATIONS:

KK - Knuckle-Knuckle

Add the following number to the part no. for desired color:

1-Forest Green 2-Midnight Black 3-Sierra Brown

High Security and Mini Mesh

10 Gauge Core / 9 Gauge Finish Permafused (Fused and Adhered)

Meets ASTM F 668, Class 2b • Feet Per Roll: 25 (50 ft for 1-1/4")

HEIGHT	3/8"		1/2"		5/8"	
	KK PART NO.	WEIGHT PER FT.	KK PART NO.	WEIGHT PER FT.	KK PART NO.	WEIGHT PER FT.
3'	MM066_	9.37	MM077_	7.71	MM088_	6.17
42"	MM067_	10.93	MM078_	9.00	MM089_	7.20
4'	MM068_	12.49	MM079_	10.28	MM090_	8.23
5'	MM069_	15.62	MM080_	12.85	MM091_	10.29
6'	MM070_	18.74	MM081_	15.42	MM092_	12.35
7'	MM071_	21.86	MM082_	17.99	MM093_	14.41
8'	MM072_	24.98	MM083_	20.56	MM094_	16.46
9'	MM073_	28.11	MM084_	23.13	MM095_	18.52
10'	MM074_	31.23	MM085_	25.70	MM096_	20.58
11'	MM075_	34.35	MM086_	28.27	MM097_	22.64
12'	MM076_	37.48	MM087_	30.84	MM098_	24.70

HEIGHT	3/4"		1"		1-1/4"	
	KK PART NO.	WEIGHT PER FT.	KK PART NO.	WEIGHT PER FT.	KK PART NO.	WEIGHT PER FT.
3'	MM099_	5.17	MM110_	3.96	MM121_	3.54
42"	MM100_	6.04	MM111_	4.62	MM122_	4.13
4'	MM101_	6.90	MM112_	5.28	MM123_	4.72
5'	MM102_	8.62	MM113_	6.60	MM124_	5.90
6'	MM103_	10.35	MM114_	7.92	MM125_	7.08
7'	MM104_	12.07	MM115_	9.24	MM126_	8.26
8'	MM105_	13.80	MM116_	10.56	MM127_	9.44
9'	MM106_	15.52	MM117_	11.88	MM128_	10.62
10'	MM107_	17.25	MM118_	13.20	MM129_	11.80
11'	MM108_	18.97	MM119_	14.52	MM130_	12.98
12'	MM109_	20.70	MM120_	15.84	MM131_	14.16

Extra charge for broken rolls.

Setup charges may apply for quantities less than 300' for non-stock items. Please inquire at your local branch.

SELVAGE ABBREVIATIONS:

KK - Knuckle-Knuckle

Add the following number to the part no. for desired color:

1-Forest Green 2-Midnight Black 3-Sierra Brown

9 Gauge Core / 8 Gauge Finish Permafused (Fused and Adhered)

Meets ASTM F 668, Class 2b • Feet Per Roll: 25 (50 ft for 1-1/4")

HEIGHT	3/8"		1/2"		5/8"	
	KK PART NO.	WEIGHT PER FT.	KK PART NO.	WEIGHT PER FT.	KK PART NO.	WEIGHT PER FT.
3'	MM000_	11.91	MM011_	9.06	MM022_	7.17
42"	MM001_	13.89	MM012_	10.56	MM023_	8.37
4'	MM002_	15.88	MM013_	12.07	MM024_	9.56
5'	MM003_	19.85	MM014_	15.09	MM025_	11.96
6'	MM004_	23.81	MM015_	18.11	MM026_	14.28
7'	MM005_	27.78	MM016_	21.13	MM027_	16.74
8'	MM006_	31.75	MM017_	24.15	MM028_	19.13
9'	MM007_	35.72	MM018_	27.17	MM029_	21.52
10'	MM008_	39.69	MM019_	30.18	MM030_	23.91
11'	MM009_	43.66	MM020_	33.20	MM031_	26.30
12'	MM010_	47.63	MM021_	36.22	MM032_	28.69

HEIGHT	3/4"		1"		1-1/4"	
	KK PART NO.	WEIGHT PER FT.	KK PART NO.	WEIGHT PER FT.	KK PART NO.	WEIGHT PER FT.
3'	MM033_	6.03	MM044_	4.53	MM055_	3.62
42"	MM034_	7.03	MM045_	5.28	MM056_	4.22
4'	MM035_	8.04	MM046_	6.04	MM057_	4.82
5'	MM036_	10.05	MM047_	7.55	MM058_	6.03
6'	MM037_	12.05	MM048_	9.06	MM059_	7.23
7'	MM038_	14.06	MM049_	10.56	MM060_	8.44
8'	MM039_	16.07	MM050_	12.07	MM061_	9.64
9'	MM040_	18.08	MM051_	13.58	MM062_	10.85
10'	MM041_	20.09	MM052_	15.09	MM063_	12.05
11'	MM042_	22.10	MM053_	16.60	MM064_	13.26
12'	MM043_	24.11	MM054_	18.11	MM065_	14.46

Extra charge for broken rolls.

Setup charges may apply for quantities less than 300' for non-stock items. Please inquire at your local branch.

SELVAGE ABBREVIATIONS:

KK - Knuckle-Knuckle

Add the following number to the part no. for desired color:

1-Forest Green 2-Midnight Black 3-Sierra Brown

Pipe and Tube make up the framework for the Chain Link fence system. ASTM specifications, wall thickness, and outside diameter (O.D.) sizes determine a framework's strength. Pipe and tube can be galvanized or color coated.

Different manufacturing processes:

- Hot-Dip
- Pre-Galv
- Flo-Coat
- Spectra Polyester (color)
- Heavy Mil (color)

Hot Dip

Hot-Dip galvanized pipe is formed before being galvanized and coated with chromate inside and out for protection against corrosion and white rust. Meets or exceeds ASTM F 1083 and ASTM F 1043.

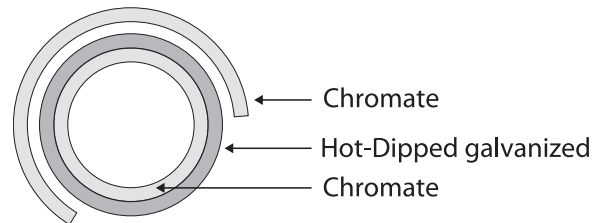

Pre-Galv

Pre-Galvanized pipe is made from hot-dip galvanized flat roll that is then formed and welded. It is treated with Conversion Coating inhibiting white rust and with a clear exterior seal coating.

Pre-Galv meets or exceeds ASTM F 1043 – 6 Standard Specification for Strength.

Pre-Galv also meets or exceeds ASTM F 1043 – 10 Type B, 0.9oz Zinc Coating.

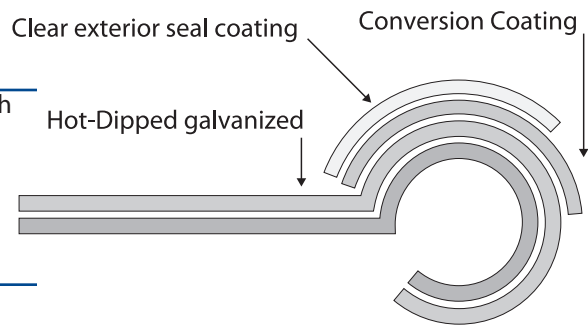

Flo-Coat

Flo-Coat Galvanized is high yield, high tensile cold formed steel that is molded and welded and then given a uniform hot-dip zinc coating. On top of the hot-dip coating, there is added first a Conversion Coating and above that, a Clear Organic Coating.

Flo-Coat meets or exceeds ASTM F 1043, Group IC.

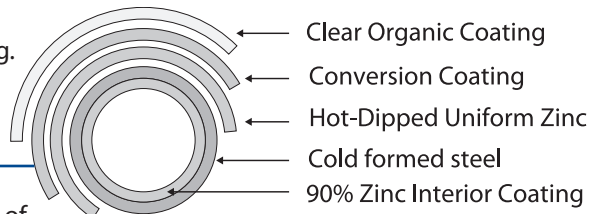

Spectra Polyester (color)

Spectra Polyester has an 11 stage pre-treatment and coating process. It is corrosion resistant and UV resistant.

Spectra Polyester meets or exceeds ASTM F 668 and ASTM F 1043 3-5 Mils.

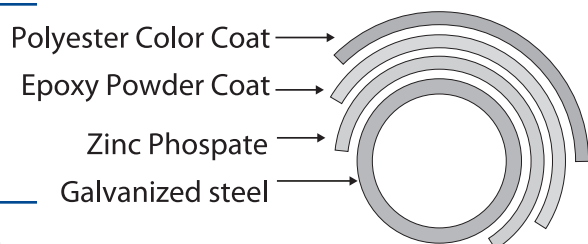

Heavy Mil (color)

Heavy Mil is coated in Poly Vinyl Chloride powder and has an 8 stage pre-treatment and coating process. It is corrosion resistant and UV resistant. Heavy Mil pipe meets or exceeds ASTM F 668 and F 1043 Type A 12-15 Mils. Heavy Mil Domestic Schedule 40 and Heavy Mil Flo Coat and Pre-Galv are both USA Certified.

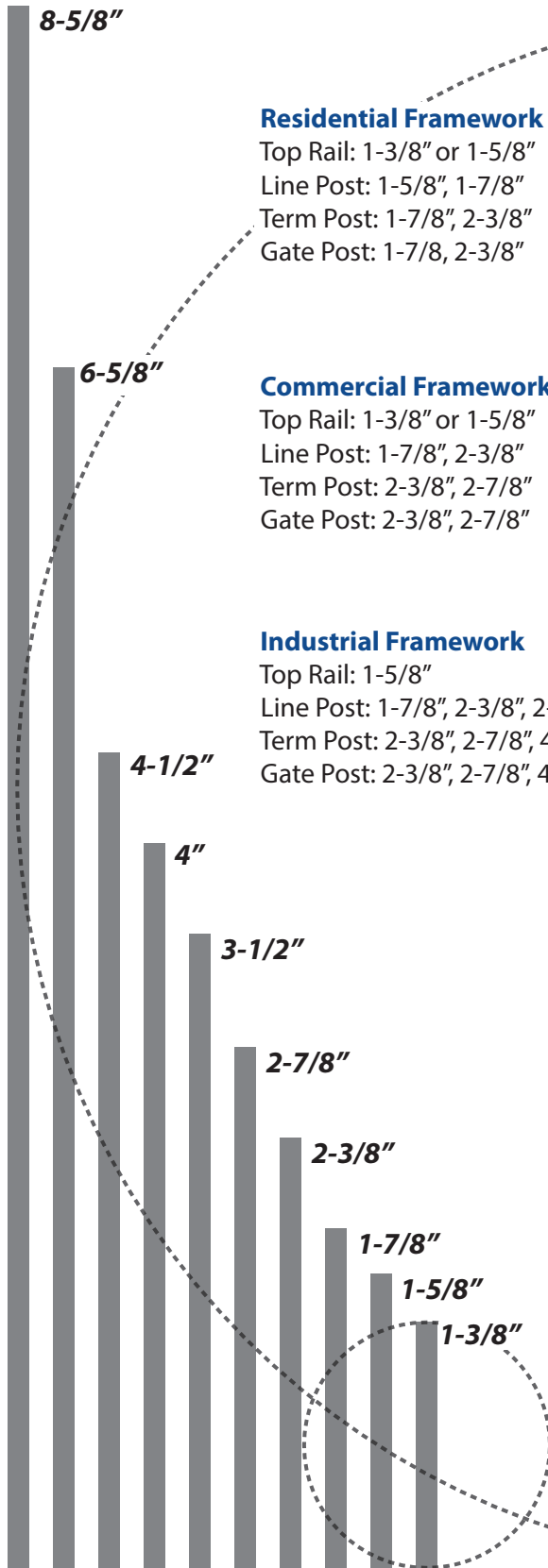

Residential Framework

Top Rail: 1-3/8" or 1-5/8"
Line Post: 1-5/8", 1-7/8"
Term Post: 1-7/8", 2-3/8"
Gate Post: 1-7/8", 2-3/8"

Commercial Framework

Top Rail: 1-3/8" or 1-5/8"
Line Post: 1-7/8", 2-3/8"
Term Post: 2-3/8", 2-7/8"
Gate Post: 2-3/8", 2-7/8"

Industrial Framework

Top Rail: 1-5/8"
Line Post: 1-7/8", 2-3/8", 2-7/8", 4"
Term Post: 2-3/8", 2-7/8", 4"
Gate Post: 2-3/8", 2-7/8", 4", 6-5/8", 8-5/8"

Residential	Wall Thickness	Gauge
Dura-Lite 18 Gauge	.047	18
Dura-Lite 17 Gauge	.055	17
Dura-Tube 16 Gauge	.065	16
RQ 15 Residential Quality	.072	15

Commercial	O.D.	Wall Thickness	Gauge
CQ 20 Commercial Quality	1-3/8"	.080	14
	1-5/8"	.085	14
	1-7/8"	.090	13
	2-3/8"	.095	13
	2-7/8"	.110	12

NOTE: The diameters listed on this page for top rail and posts are meant to be suggestions for framework sizing.

Industrial	O.D.	Wall Thickness	Gauge
DQ 40 Deluxe Quality	1-5/8"	.111	12
	1-7/8"	.120	11
	2-3/8"	.130	10
	2-7/8"	.160	9
Full Weight - Sch. 40 1.8 oz.	4"	.160	8
	1-5/8"	.140	9-1/2
	1-7/8"	.145	9
	2-3/8"	.154	8
	2-7/8"	.203	6
Full Weight - Sch. 40 2.0 oz.	4"	.226	5
	6-5/8"	.280	1
	8-5/8"	.322	1/0
	1-5/8"	.140	9-1/2
	1-7/8"	.145	9
Full Weight - Sch. 40 2.0 oz.	2-3/8"	.154	8
	2-7/8"	.203	6
	4"	.226	5

Dura-Lite 18 Gauge • Galvanized Tubing

Dura-Lite 18 Gauge / Nominal wall thickness .047

DESCRIPTION	21'	PART NO. 22'	24'	PIECES PER BUNDLE	WEIGHT PER FT.	NOTES
1-3/8" O.D. - PE	030188	030284	030126	91	.65	
1-3/8" O.D. - SE	030104	030291	030123	91	.65	
1-5/8" O.D. - PE	030108	030109	030110	61	.81	
1-5/8" O.D. - SE	030180	030117	030181	61	.81	
1-7/8" O.D.	030455	—	030457	61	.94	
2-3/8" O.D.	030184	—	030185	37	1.18	

1-3/8" O.D. Dura-Lite 18 Gauge / Nominal wall thickness .047

DESCRIPTION	PART NO.	PIECES PER BUNDLE	WEIGHT EA.	NOTES
10' 6" - SE	030099	91	6.82	

1-5/8" O.D. Dura-Lite Posts 18 Gauge / Nominal wall thickness .047

DESCRIPTION	PART NO.	PIECES PER BUNDLE	WEIGHT EA.	NOTES
5'	030190	61	4.04	
5' 6"	030191	61	4.45	
6'	030192	61	4.85	
6' 6"	030193	61	5.27	
7'	030194	61	5.66	
7' 6"	030195	61	6.08	
8'	030196	61	6.48	

SPECIAL NOTE: Call us for all your special needs: Drilled Posts, Welded Plates, Post Bending, etc.

1-7/8" O.D. Dura-Lite Posts 18 Gauge / Nominal wall thickness .047

DESCRIPTION	PART NO.	PIECES PER BUNDLE	WEIGHT EA.	NOTES
5'	030461	61	4.69	
5' 6"	030462	61	5.16	
6'	030463	61	5.63	
7'	030465	61	6.56	
7' 6"	030466	61	7.03	
8'	030467	61	7.50	

2-3/8" O.D. Dura-Lite Posts 18 Gauge / Nominal wall thickness .047

DESCRIPTION	PART NO.	PIECES PER BUNDLE	WEIGHT EA.	NOTES
5'	030821	37	5.90	
5' 6"	030822	37	6.50	
6'	030823	37	7.10	
6' 6"	030824	37	7.67	
7'	030825	37	8.26	
7' 6"	030826	37	8.85	
8'	030827	37	9.45	

Dura-Lite 17 Gauge • Galvanized Tubing

Dura-Lite 17 Gauge / Nominal wall thickness .055

DESCRIPTION	21'	PART NO. 22'	24'	PIECES PER BUNDLE	WEIGHT PER FT.	NOTES
1-3/8" O.D. - PE	030101	029003	030125	91	.74	
1-3/8" O.D. - SE	030105	029010	029012	91	.74	
1-5/8" O.D. - PE	030111	030112	030113	61	.95	
1-5/8" O.D. - SE	030115	030116	029026	61	.95	
1-7/8" O.D.	030121	030122	030124	61	1.09	
2-3/8" O.D.	030131	—	030134	37	1.37	

1-3/8" O.D. Dura-Lite 17 Gauge / Nominal wall thickness .055

DESCRIPTION	PART NO.	PIECES PER BUNDLE	WEIGHT EA.	NOTES
10' 6" - SE	030007	91	7.76	

1-5/8" O.D. Dura-Lite Posts 17 Gauge / Nominal wall thickness .055

DESCRIPTION	PART NO.	PIECES PER BUNDLE	WEIGHT EA.	NOTES
4' 6"	030150	61	4.26	
5'	030151	61	4.75	
5' 6"	030152	61	5.23	
6'	030153	61	5.70	
6' 6"	030154	61	6.18	
7'	030155	61	6.63	
7' 6"	030156	61	7.13	
8'	030157	61	7.60	

1-7/8" O.D. Dura-Lite Posts 17 Gauge / Nominal wall thickness .055

DESCRIPTION	PART NO.	PIECES PER BUNDLE	WEIGHT EA.	NOTES
5'	030161	61	5.45	
5' 6"	030162	61	6.00	
6'	030163	61	6.54	
6' 6"	030164	61	7.09	
7'	030165	61	7.63	
7' 6"	030166	61	8.18	
8'	030167	61	8.72	
8' 6"	030168	61	9.27	

SPECIAL NOTE: Call us for all your special needs: Drilled Posts, Welded Plates, Post Bending, etc.

2-3/8" O.D. Dura-Lite Posts 17 Gauge / Nominal wall thickness .055

DESCRIPTION	PART NO.	PIECES PER BUNDLE	WEIGHT EA.	NOTES
5'	030171	37	6.85	
5' 6"	030172	37	7.54	
6'	030173	37	8.22	
6' 6"	030174	37	8.91	
7'	030175	37	9.59	
7' 6"	030176	37	10.28	
8'	030177	37	10.96	
8' 6"	030178	37	11.65	
9'	030186	37	12.33	
10'	030179	37	13.70	

SPECIAL NOTE: Call us for all your special needs: Drilled Posts, Welded Plates, Post Bending, etc.

Dura-Tube 16 Gauge • Galvanized Tubing

Dura-Tube 16 Gauge / Nominal wall thickness .065

DESCRIPTION	PART NO.			PIECES PER BUNDLE	WEIGHT PER FT.	NOTES
	21'	22'	24'			
1-3/8" O.D. - PE	030501	—	030502	91	.87	
1-3/8" O.D. - SE	030505	—	030506	91	.87	
1-5/8" O.D. - PE	030510	—	030512	61	1.11	
1-5/8" O.D. - SE	030515	030516	030388	61	1.11	
1-7/8" O.D.	030520	030521	030522	61	1.28	
2-3/8" O.D.	030525	—	030527	37	1.60	

1-5/8" O.D. Dura-Tube Posts 16 Gauge / Nominal wall thickness .065

DESCRIPTION	PART NO.	PIECES PER BUNDLE	WEIGHT EA.	NOTES
4' 6"	030540	61	5.00	
5'	030541	61	5.55	
5' 6"	030542	61	6.11	
6'	030543	61	6.66	
6' 6"	030544	61	7.22	
7'	030545	61	7.77	
7' 6"	030546	61	8.33	
8'	030547	61	8.88	

1-7/8" O.D. Dura-Tube Posts 16 Gauge / Nominal wall thickness .065

DESCRIPTION	PART NO.	PIECES PER BUNDLE	WEIGHT EA.	NOTES
5'	030551	61	6.40	
5' 6"	030552	61	7.04	
6'	030553	61	7.68	
6' 6"	030554	61	8.32	
7'	030555	61	8.96	
7' 6"	030556	61	9.60	
8'	030557	61	10.24	
8' 6"	030558	61	10.88	

SPECIAL NOTE: Call us for all your special needs: Drilled Posts, Welded Plates, Post Bending, etc.

2-3/8" O.D. Dura-Tube Posts 16 Gauge / Nominal wall thickness .065

DESCRIPTION	PART NO.	PIECES PER BUNDLE	WEIGHT EA.	NOTES
5'	030561	37	8.00	
5' 6"	030562	37	8.80	
6'	030563	37	9.60	
6' 6"	030564	37	10.40	
7'	030565	37	11.20	
7' 6"	030566	37	12.00	
8'	030567	37	12.80	
8' 6"	030568	37	13.60	
9'	030569	37	14.40	
10'	030570	37	16.00	
11'	030571	37	17.60	
12'	030572	37	19.20	

SPECIAL NOTE: Call us for all your special needs: Drilled Posts, Welded Plates, Post Bending, etc.

RQ 15 • Galvanized Pipe

RQ 15

DESCRIPTION	PART NO.			PIECES PER BUNDLE	WEIGHT PER FT.	NOMINAL WALL THICKNESS	NOTES
	21'	22'	24'				
1-3/8" O.D. - PE	030901	—	030904	91	.95	.072	
1-3/8" O.D. - SE	030902	—	030903	91	.95	.072	
1-5/8" O.D. - PE	030905	—	030907	61	1.22	.072	
1-5/8" O.D. - SE	030916	—	030844	61	1.22	.072	
1-7/8" O.D.	030909	—	030911	61	1.41	.072	
2-3/8" O.D.	030913	—	030915	37	1.88	.076	

1-5/8" O.D. RQ 15 Posts / Nominal wall thickness .072

DESCRIPTION	PART NO.	PIECES PER BUNDLE	WEIGHT EA.	NOTES
5'	030906	61	6.10	
5' 6"	030908	61	6.71	
6'	030910	61	7.32	
6' 6"	030912	61	7.93	
7'	030925	61	8.50	
7' 6"	030918	61	9.15	
8'	030914	61	9.76	
9'	029063	61	10.98	
10'	029064	61	12.20	

1-7/8" O.D. RQ 15 Posts / Nominal wall thickness .072

DESCRIPTION	PART NO.	PIECES PER BUNDLE	WEIGHT EA.	NOTES
5'	030919	61	7.05	
5' 6"	030920	61	7.76	
6'	030921	61	8.46	
6' 6"	030922	61	9.17	
7'	030923	61	9.87	
8'	030927	61	11.28	
9'	030928	61	12.69	
10'	030929	61	14.10	
11'	030859	61	15.51	
12'	030847	61	16.92	

SPECIAL NOTE: Call us for all your special needs: Drilled Posts, Welded Plates, Post Bending, etc.

2-3/8" O.D. RQ 15 Posts / Nominal wall thickness .076

DESCRIPTION	PART NO.	PIECES PER BUNDLE	WEIGHT EA.	NOTES
5'	030930	37	9.40	
5' 6"	030931	37	10.34	
6'	030932	37	11.28	
6' 6"	030933	37	12.22	
7'	030934	37	13.16	
7' 6"	030936	37	14.10	
8'	030937	37	15.04	
9'	030939	37	16.92	
10'	030940	37	18.80	
10' 6"	030941	37	19.74	
11'	030853	37	20.68	
12'	030942	37	22.56	

SPECIAL NOTE: Call us for all your special needs: Drilled Posts, Welded Plates, Post Bending, etc.

CQ 20 • Galvanized Pipe

CQ 20

DESCRIPTION	18'	PART NO. 21'	24'	PIECES PER BUNDLE	WEIGHT PER FT.	NOMINAL WALL THICKNESS	NOTES
1-3/8" O.D. - PE	032564	032601	032602	91	1.06	.080	
1-3/8" O.D. - SE	032565	032604	032566	91	1.06	.080	
1-5/8" O.D. - PE	032567	032605	032607	61	1.46	.085	
1-5/8" O.D. - SE	032568	032608	032606	61	1.46	.085	
1-7/8" O.D.	032609	032610	032612	61	1.75	.090	
2-3/8" O.D.	032614	032615	032617	37	2.29	.095	
2-7/8" O.D.	032619	032620	032622	19	3.25	.110	

1-5/8" O.D. CQ 20 Posts / Nominal wall thickness .085

DESCRIPTION	PART NO.	PIECES PER BUNDLE	WEIGHT EA.	NOTES
4' 6"	032746	61	6.57	
5'	032747	61	7.30	
5' 6"	032631	61	8.06	
6'	032632	61	8.76	
6' 6"	032633	61	9.49	
7'	032634	61	10.22	
7' 6"	032635	61	10.95	
8'	032636	61	11.68	
9'	032638	61	13.14	
10'	032640	61	14.60	

1-7/8" O.D. CQ 20 Posts / Nominal wall thickness .090

DESCRIPTION	PART NO.	PIECES PER BUNDLE	WEIGHT EA.	NOTES
5'	032576	61	8.75	
5' 6"	032651	61	9.63	
6'	032652	61	10.50	
6' 6"	032642	61	11.38	
7'	032654	61	12.25	
7' 6"	032655	61	13.13	
8'	032656	61	14.00	
9'	032658	61	15.75	
10'	032659	61	17.50	
10' 6"	032664	61	18.38	
11'	032660	61	19.25	
12'	032662	61	21.00	

SPECIAL NOTE: Call us for all your special needs: Drilled Posts, Welded Plates, Post Bending, etc.

2-3/8" O.D. CQ 20 Posts / Nominal wall thickness .095

DESCRIPTION	PART NO.	PIECES PER BUNDLE	WEIGHT EA.	NOTES
5'	032670	37	11.50	
5' 6"	032671	37	12.65	
6'	032672	37	13.80	
6' 6"	032661	37	14.95	
7'	032674	37	16.10	
7' 6"	032673	37	17.25	
8'	032676	37	18.40	
9'	032678	37	20.70	
10'	032679	37	23.00	
10' 6"	032680	37	24.15	
11'	032681	37	25.30	
12'	032683	37	27.60	
13'	032685	37	29.90	

2-7/8" O.D. CQ 20 Posts / Nominal wall thickness .110

DESCRIPTION	PART NO.	PIECES PER BUNDLE	WEIGHT EA.	NOTES
6'	032701	19	19.50	
7'	032684	19	22.75	
8'	032686	19	26.00	
9'	032687	19	29.25	
10'	032688	19	32.50	
10' 6"	032689	19	34.13	
11'	032692	19	35.75	
12'	032694	19	39.00	
12' 6"	032697	19	40.63	
13'	032695	19	42.25	

SPECIAL NOTE: Call us for all your special needs: Drilled Posts, Welded Plates, Post Bending, etc.

Structural (Schedule 20) • Galvanized Pipe

Structural (Schedule 20)

DESCRIPTION	PART NO.			PIECES PER BUNDLE	WEIGHT PER FT.	NOMINAL WALL THICKNESS	NOTES
	18'	21'	24'				
1-3/8" O.D. - PE	031750	031751	031753	91	1.35	.104	
1-5/8" O.D. - PE	031901	031902	031904	61	1.73	.104	
1-7/8" O.D.	032101	032102	032104	61	2.21	.116	
2-3/8" O.D.	032300	032302	032304	37	2.80	.116	
2-7/8" O.D.	032500	032502	032504	19	3.75	.128	

1-5/8" O.D. Structural Posts / Nominal wall thickness .104

DESCRIPTION	PART NO.	PIECES PER BUNDLE	WEIGHT EA.	NOTES
5' 6"	031952	61	9.52	
6'	031953	61	10.37	
6' 6"	031954	61	11.25	
7'	031955	61	12.10	
7' 6"	031956	61	12.98	
8'	031957	61	13.83	
9'	031959	61	15.56	
10'	031960	61	17.29	

1-7/8" O.D. Structural Posts / Nominal wall thickness .116

DESCRIPTION	PART NO.	PIECES PER BUNDLE	WEIGHT EA.	NOTES
5'	032151	61	11.01	
5' 6"	032152	61	12.11	
6'	032153	61	13.21	
6' 6"	032154	61	14.31	
7'	032155	61	15.41	
7' 6"	032156	61	16.58	
8'	032157	61	17.61	
8' 8"	032158	61	18.79	
9'	032159	61	19.81	
10'	032160	61	22.01	
11'	032166	61	24.31	
12'	032165	61	26.52	

SPECIAL NOTE: Call us for all your special needs: Drilled Posts, Welded Plates, Post Bending, etc.

2-3/8" O.D. Structural Posts / Nominal wall thickness .116

DESCRIPTION	PART NO.	PIECES PER BUNDLE	WEIGHT EA.	NOTES
5'	032351	37	14.00	
5' 6"	032352	37	15.40	
6'	032353	37	16.67	
6' 6"	032354	37	18.20	
7'	032355	37	19.45	
7' 6"	032356	37	20.85	
8'	032357	37	22.23	
8' 8"	032358	37	23.80	
9'	032359	37	25.01	
10'	032360	37	27.79	
11'	032172	37	30.80	
12'	032364	37	33.60	

2-7/8" O.D. Structural Posts / Nominal wall thickness .128

DESCRIPTION	PART NO.	PIECES PER BUNDLE	WEIGHT EA.	NOTES
6'	032553	19	22.50	
7'	032555	19	26.25	
8'	032557	19	30.00	
9'	032559	19	33.75	
10'	032560	19	37.50	
11'	032561	19	41.25	
12'	032562	19	45.00	
13'	032178	19	48.75	

SPECIAL NOTE: Call us for all your special needs: Drilled Posts, Welded Plates, Post Bending, etc.

HQ 30 • Galvanized Pipe

HQ 30 / Meets ASTM F 1043 Group IV

DESCRIPTION	PART NO.			PIECES PER BUNDLE	WEIGHT PER FT.	NOMINAL WALL THICKNESS	NOTES
	18'	21'	24'				
1-5/8" O.D. - PE	032800	032801	032802	61	1.59	.095	
1-5/8" O.D. - SE	032803	032804	032805	61	1.59	.095	
1-7/8" O.D.	032806	032807	032808	61	2.01	.105	
2-3/8" O.D.	032809	032810	032811	37	2.78	.115	
2-7/8" O.D.	032812	032813	032814	19	3.81	.130	
4" O.D.	032815	032816	032817	19	5.78	.140	

1-5/8" O.D. HQ 30 Posts / Meets ASTM F 1043 Group IV • Nominal wall thickness .095

DESCRIPTION	PART NO.	PIECES PER BUNDLE	WEIGHT EA.	NOTES
5'	032818	61	7.95	
5' 6"	032819	61	8.75	
6'	032820	61	9.54	
6' 6"	032821	61	10.34	
7'	032822	61	11.13	
7' 6"	032823	61	11.93	
8'	032824	61	12.72	
8' 6"	032825	61	13.52	
9'	032826	61	14.31	
10'	032827	61	15.90	

1-7/8" O.D. HQ 30 Posts / Meets ASTM F 1043 Group IV • Nominal wall thickness .105

DESCRIPTION	PART NO.	PIECES PER BUNDLE	WEIGHT EA.	NOTES
5'	032828	61	10.05	
5' 6"	032829	61	11.06	
6'	032830	61	12.06	
6' 6"	032831	61	13.07	
7'	032832	61	14.07	
7' 6"	032833	61	15.08	
8'	032834	61	16.08	
8' 6"	032835	61	17.09	
9'	032836	61	18.09	
10'	032837	61	20.10	
11'	032838	61	22.11	
12'	032839	61	24.12	

SPECIAL NOTE: Call us for all your special needs: Drilled Posts, Welded Plates, Post Bending, etc.

2-3/8" O.D. HQ 30 Posts / Meets ASTM F 1043 Group IV • Nominal wall thickness .115

DESCRIPTION	PART NO.	PIECES PER BUNDLE	WEIGHT EA.	NOTES
5'	032840	37	13.90	
5' 6"	032841	37	15.29	
6'	032842	37	16.68	
6' 6"	032843	37	18.07	
7'	032844	37	19.46	
7' 6"	032845	37	20.85	
8'	032846	37	22.24	
8' 6"	032847	37	23.63	
9'	032848	37	25.02	
10'	032849	37	27.80	
11'	032850	37	30.58	
12'	032851	37	33.36	
13'	032852	37	36.14	

2-7/8" O.D. HQ 30 Posts / Meets ASTM F 1043 Group IV • Nominal wall thickness .130

DESCRIPTION	PART NO.	PIECES PER BUNDLE	WEIGHT EA.	NOTES
5'	032853	19	19.05	
5' 6"	032854	19	22.86	
6'	032855	19	24.77	
6' 6"	032856	19	26.67	
7'	032857	19	28.58	
7' 6"	032858	19	30.48	
8'	032859	19	32.39	
8' 6"	032860	19	34.29	
9'	032861	19	38.10	
10'	032862	19	40.01	
11'	032863	19	41.91	
12'	032864	19	45.72	
13'	032865	19	49.53	
15'	032866	19	57.15	

SPECIAL NOTE: Call us for all your special needs: Drilled Posts, Welded Plates, Post Bending, etc.

HQ 30 • Galvanized Pipe

4" O.D. HQ 30 Posts / Meets ASTM F 1043 Group IV • Nominal wall thickness .140

DESCRIPTION	PART NO.	PIECES PER BUNDLE	WEIGHT EA.	NOTES
5'	032867	19	28.90	
6'	032868	19	34.68	
7'	032869	19	40.46	
8'	032870	19	46.24	
8' 6"	032871	19	49.13	
9'	032872	19	52.02	
10'	032873	19	57.80	
11'	032874	19	63.58	
12'	032875	19	69.36	
13'	032876	19	75.14	
14'	032877	19	80.92	
15'	032878	19	86.70	

SPECIAL NOTE: Call us for all your special needs: Drilled Posts, Welded Plates, Post Bending, etc.

DQ 40 / Meets ASTM F 1043 Group IC

DESCRIPTION	18'	PART NO. 21'	24'	PIECES PER BUNDLE	WEIGHT PER FT.	NOMINAL WALL THICKNESS	NOTES
1-3/8" O.D. - PE	032970	033002	032978	91	1.34	.104	
1-5/8" O.D. - PE	033003	033005	033007	61	1.83	.111	
1-5/8" O.D. - SE	032954	033004	032957	61	1.83	.111	
1-7/8" O.D.	033009	033010	033012	61	2.28	.120	
2-3/8" O.D.	033014	033015	033017	37	3.12	.130	
2-7/8" O.D.	033019	033020	033022	19	4.64	.160	
4" O.D.	032936	033024	033027	19	6.56	.160	

1-5/8" O.D. DQ 40 Posts / Meets ASTM F 1043 Group IC • Nominal wall thickness .111

DESCRIPTION	PART NO.	PIECES PER BUNDLE	WEIGHT EA.	NOTES
5'	032900	61	9.16	
5' 6"	033035	61	9.90	
6'	033032	61	11.10	
6' 6"	033033	61	11.90	
7'	033034	61	12.95	
7' 6"	033037	61	13.73	
8'	033036	61	14.80	
9'	033070	61	16.47	
10'	033039	61	18.50	

1-7/8" O.D. DQ 40 Posts / Meets ASTM F 1043 Group IC • Nominal wall thickness .120

DESCRIPTION	PART NO.	PIECES PER BUNDLE	WEIGHT EA.	NOTES
5'	032906	61	11.40	
5' 6"	033040	61	12.54	
6'	033043	61	13.50	
7'	033044	61	15.75	
8'	033046	61	18.00	
8' 8"	033047	61	19.13	
9'	033048	61	20.25	
10'	033049	61	22.50	
11'	033050	61	25.08	
12'	033093	61	27.36	

SPECIAL NOTE: Call us for all your special needs: Drilled Posts, Welded Plates, Post Bending, etc.

Chain Link - Pipe and Tube



DQ 40 • Galvanized Pipe

2-3/8" O.D. DQ 40 Posts / Meets ASTM F 1043 Group IC • Nominal wall thickness .130

DESCRIPTION	PART NO.	PIECES PER BUNDLE	WEIGHT EA.	NOTES
5'	032912	37	15.55	
5'6"	033094	37	17.11	
6'	033052	37	18.66	
6'6"	033095	37	20.22	
7'	033054	37	21.77	
8'	033056	37	24.88	
8'8"	033057	37	26.44	
9'	033058	37	27.99	
10'	033059	37	31.10	
10'6"	033063	37	32.66	
11'	033061	37	34.21	
12'	033060	37	37.32	
13'	033062	37	40.43	
14'	033111	37	43.54	
15'	033064	37	46.65	

2-7/8" O.D. DQ 40 Posts / Meets ASTM F 1043 Group IC • Nominal wall thickness .160

DESCRIPTION	PART NO.	PIECES PER BUNDLE	WEIGHT EA.	NOTES
5'	032913	19	23.20	
6'	033074	19	27.84	
7'	033075	19	32.48	
8'	033076	19	37.12	
9'	033078	19	41.76	
10'	033079	19	46.40	
10'6"	033083	19	48.72	
11'	033080	19	51.04	
12'	033081	19	55.68	
13'	033082	19	60.32	
14'	033120	19	64.96	
15'	033084	19	69.60	

SPECIAL NOTE: Call us for all your special needs: Drilled Posts, Welded Plates, Post Bending, etc.

4" O.D. DQ 40 Posts / Meets ASTM F 1043 Group IV • Nominal wall thickness .160

DESCRIPTION	PART NO.	PIECES PER BUNDLE	WEIGHT EA.	NOTES
5'	033065	19	33.00	
6'	033066	19	40.00	
7'	033067	19	46.00	
8'	033041	19	52.48	
9'	033028	19	59.04	
10'	033029	19	65.60	
10' 6"	033042	19	68.88	
11'	033030	19	72.16	
12'	033031	19	78.72	
13'	033068	19	85.28	
14'	033129	19	91.84	
15'	033069	19	98.40	

SPECIAL NOTE: Call us for all your special needs: Drilled Posts, Welded Plates, Post Bending, etc.

Chain Link - Pipe and Tube



Import Full Weight (Schedule 40) • 1.8 oz. Galvanized Pipe

Import Full Weight (Schedule 40) / 1.8 oz.

DESCRIPTION	PART NO.			PIECES PER BUNDLE	WEIGHT PER FT.	NOMINAL WALL THICKNESS	NOTES
	18'	21'	24'				
1-3/8" O.D. - PE	033495	033500	033552	60	1.68	.133	
1-5/8" O.D. - PE	033554	033551	033553	42	2.27	.140	
1-7/8" O.D.	033711	033712	033714	36	2.72	.145	
2-3/8" O.D.	033950	033952	033954	26	3.65	.154	
2-7/8" O.D.	034280	034282	034284	18	5.79	.203	
3-1/2" O.D.	034286	034287	034289	14	7.58	.216	
4" O.D.	034469	034471	034473	12	9.11	.226	
4-1/2" O.D.	034475	034477	034479	10	10.79	.237	
6-5/8" O.D.	034503	034502	034504	5	18.97	.280	
8-5/8" O.D.	034509	034511	034513	1	28.55	.322	

1-5/8" O.D. Import Full Weight Posts (Schedule 40) / 1.8 oz. • Nominal wall thickness .140

DESCRIPTION	PART NO.	PIECES PER BUNDLE	WEIGHT EA.	NOTES
5'	033561	42	11.35	
5'6"	033562	42	12.49	
6'	033563	42	13.62	
6'6"	033564	42	14.75	
7'	033565	42	15.89	
7'6"	033566	42	17.03	
8'	033567	42	18.16	
9'	033569	42	20.43	
10'	033570	42	22.70	

SPECIAL NOTE: Call us for all your special needs: Drilled Posts, Welded Plates, Post Bending, etc.

CL-58

1-7/8" O.D. Import Full Weight Posts (Schedule 40) / 1.8 oz. • Nominal wall thickness .145

DESCRIPTION	PART NO.	PIECES PER BUNDLE	WEIGHT EA.	NOTES
5'	033801	36	13.60	
5' 6"	033802	36	14.96	
6'	033803	36	16.32	
6' 6"	033814	36	17.68	
7'	033805	36	19.04	
8'	033807	36	21.76	
8' 8"	033808	36	23.58	
9'	033809	36	24.48	
10'	033810	36	27.20	
10' 6"	033813	36	28.56	
11'	033818	36	24.97	
12'	033820	36	32.64	

2-3/8" O.D. Import Full Weight Posts (Schedule 40) / 1.8 oz. • Nominal wall thickness .154

DESCRIPTION	PART NO.	PIECES PER BUNDLE	WEIGHT EA.	NOTES
5'	034101	26	18.25	
5' 6"	034102	26	20.08	
6'	034103	26	21.90	
6' 6"	034104	26	23.73	
7'	034105	26	25.55	
8'	034107	26	29.20	
8' 8"	034108	26	31.65	
9'	034109	26	32.85	
9' 8"	034111	26	35.28	
10'	034110	26	36.50	
10' 6"	034112	26	38.33	
11'	034114	26	40.15	
12'	034115	26	43.80	
13'	034117	26	47.45	
14'	034125	26	51.10	
15'	034119	26	54.75	

SPECIAL NOTE: Call us for all your special needs: Drilled Posts, Welded Plates, Post Bending, etc.

Import Full Weight (Schedule 40) • 1.8 oz. Galvanized Pipe

2-7/8" O.D. Import Full Weight Posts (Schedule 40) / 1.8 oz. • Nominal wall thickness .203

DESCRIPTION	PART NO.	PIECES PER BUNDLE	WEIGHT EA.	NOTES
5'	034332	18	28.95	
6'	034333	18	34.74	
7'	034335	18	40.53	
8'	034337	18	46.32	
9'	034339	18	52.11	
10'	034340	18	57.90	
10' 6"	034342	18	60.80	
11'	034341	18	63.69	
12'	034345	18	69.48	
13'	034347	18	75.27	
15'	034349	18	86.85	

4" O.D. Import Full Weight Posts (Schedule 40) / 1.8 oz. • Nominal wall thickness .226

DESCRIPTION	PART NO.	PIECES PER BUNDLE	WEIGHT EA.	NOTES
5'	034431	12	45.50	
6'	034433	12	54.60	
7'	034435	12	63.70	
8'	034437	12	72.80	
9'	034439	12	81.90	
10'	034440	12	91.00	
10' 6"	034443	12	95.55	
11'	034441	12	100.10	
12'	034442	12	109.20	
13'	034447	12	118.30	
14'	034449	12	127.40	
15'	034450	12	136.50	

SPECIAL NOTE: Call us for all your special needs: Drilled Posts, Welded Plates, Post Bending, etc.

6-5/8" O.D. Import Full Weight Posts (Schedule 40) / 1.8 oz. • Nominal wall thickness .280

DESCRIPTION	PART NO.	PIECES PER BUNDLE	WEIGHT EA.	NOTES
5'	034550	7	94.85	
6'	034554	7	113.82	
7'	034555	7	132.79	
8'	034557	7	151.76	
9'	034559	7	170.73	
10'	034560	7	189.70	
10' 6"	034564	7	199.10	
11'	034561	7	208.67	
12'	034562	7	227.64	
13'	034563	7	246.61	
14'	034569	7	265.58	
15'	034570	7	284.55	

8-5/8" O.D. Import Full Weight Posts (Schedule 40) / 1.8 oz. • Nominal wall thickness .322

DESCRIPTION	PART NO.	PIECES PER BUNDLE	WEIGHT EA.	NOTES
5'	034591	5	142.75	
6'	034582	5	171.30	
7'	034583	5	199.85	
8'	034584	5	228.40	
9'	034585	5	256.95	
10'	034571	5	285.50	
10' 6"	034572	5	299.78	
11'	034573	5	314.05	
12'	034575	5	342.60	
13'	034577	5	371.15	
14'	034579	5	399.70	
15'	034589	5	428.25	

SPECIAL NOTE: Call us for all your special needs: Drilled Posts, Welded Plates, Post Bending, etc.

Chain Link - Pipe and Tube



Domestic Full Weight (Schedule 40) • 1.8 oz. Galvanized Pipe

Domestic Full Weight (Schedule 40) / 1.8 oz. • Meets ASTM F 1043 Group IA and F 1083

DESCRIPTION	PART NO.			PIECES PER BUNDLE	WEIGHT PER FT.	NOMINAL WALL THICKNESS	NOTES
	18'	21'	24'				
1-5/8" O.D. - PE	034649	034610	034613	42	2.27	.140	
1-7/8" O.D. - PE	034633	034635	034638	36	2.72	.145	
2-3/8" O.D.	034659	034660	034663	26	3.65	.154	
2-7/8" O.D.	034680	034685	034688	18	5.79	.203	
4" O.D.	034689	034710	034713	12	9.11	.226	
6-5/8" O.D.	—	034711	034770	1	18.97	.280	

1-7/8" O.D. Domestic Full Weight Posts (Schedule 40) / 1.8 oz. • Meets ASTM F 1043 Group IA and F 1083 • Nominal wall thickness .145

DESCRIPTION	PART NO.	PIECES PER BUNDLE	WEIGHT EA.	NOTES
6'	034608	36	16.32	
7'	034609	36	19.04	
8'	034634	36	21.76	
8'8"	034625	36	23.57	
9'	034626	36	24.48	
10'	034614	36	27.20	
11'	034615	36	29.81	
12'	034616	36	32.64	
13'	034617	36	35.36	
14'	034618	36	38.08	
15'	034619	36	40.80	

Call Your Master Halco location for availability of domestic full weight pipe in cut posts.

2-3/8" O.D. Domestic Full Weight Posts (Schedule 40) / 1.8 oz. • Meets ASTM F 1043 Group IA and F 1083 • Nominal wall thickness .154

DESCRIPTION	PART NO.	PIECES PER BUNDLE	WEIGHT EA.	NOTES
6'	034623	26	21.90	
7'	034624	26	25.55	
8'	034674	26	29.20	
8'8"	034651	26	31.63	
9'	034652	26	32.85	
10'	034650	26	36.50	
10'6"	034655	26	38.32	
11'	034653	26	40.15	
12'	034627	26	43.80	
13'	034628	26	47.45	
14'	034629	26	51.10	
15'	034630	26	54.75	

2-7/8" O.D. Domestic Full Weight Posts (Schedule 40) / 1.8 oz. • Meets ASTM F 1043 Group IA and F 1083 • Nominal wall thickness .203

DESCRIPTION	PART NO.	PIECES PER BUNDLE	WEIGHT EA.	NOTES
6'	034640	18	34.74	
7'	034641	18	40.53	
8'	034642	18	46.32	
9'	034643	18	52.11	
10'	034675	18	57.90	
10'6"	034676	18	60.79	
11'	034677	18	63.69	
12'	034679	18	69.48	
13'	034644	18	75.27	
14'	034645	18	81.06	
15'	034646	18	86.85	

Call Your Master-Halco location for availability of domestic full weight pipe in cut posts.

Domestic Full Weight (Schedule 40) • 1.8 oz. Galvanized Pipe

4" O.D. Domestic Full Weight Posts (Schedule 40) / 1.8 oz. • Meets ASTM F 1043 Group IA and F 1083 • Nominal wall thickness .226

DESCRIPTION	PART NO.	PIECES PER BUNDLE	WEIGHT EA.	NOTES
6'	034665	12	54.66	
7'	034666	12	63.77	
8'	034667	12	72.88	
9'	034668	12	81.99	
10'	034740	12	91.10	
10' 6"	034750	12	95.65	
11'	034741	12	100.21	
12'	034742	12	109.32	
13'	034669	12	118.43	
14'	034670	12	127.54	
15'	034671	12	136.65	

6-5/8" O.D. Domestic Full Weight Posts (Schedule 40) / 1.8 oz. • Meets ASTM F 1043 Group IA and F 1083 • Nominal wall thickness .280

DESCRIPTION	PART NO.	PIECES PER BUNDLE	WEIGHT EA.	NOTES
6'	034765	7	54.66	
7'	499V00	7	63.77	
8'	709D00	7	72.88	
10' 6"	034769	7	95.65	
11'	034810	7	100.21	
12'	034768	7	109.32	
12' 6"	034753	7	113.82	
13'	222F00	7	118.43	
15'	034811	7	127.54	
17'	034812	7	136.65	

Call Your Master-Halco location for availability of domestic full weight pipe in cut posts.

Domestic Full Weight (Schedule 40) / 2 oz. • Meets ASTM F 1043 Group IA and F 1083

DESCRIPTION	PART NO.			PIECES PER BUNDLE	WEIGHT PER FT.	NOMINAL WALL THICKNESS	NOTES
	18'	21'	24'				
1-5/8" O.D. - PE	—	034716	034717	42	2.36	.140	
1-7/8" O.D. - PE	—	034719	034721	36	2.83	.145	
2-3/8" O.D.	034724	034727	034730	26	3.79	.154	
2-7/8" O.D.	034732	034733	034736	18	6.03	.203	
4" O.D.	034745	034746	034749	12	9.36	.226	

1-5/8" O.D. Full Weight Posts (Schedule 40) / 2 oz. • Meets ASTM F 1043 Group IA and F 1083 • Nominal wall thickness .140

DESCRIPTION	PART NO.	PIECES PER BUNDLE	WEIGHT EA.	NOTES
6'	033587	42	13.62	
6' 6"	033588	42	14.76	
7'	033589	42	15.89	
7' 6"	033590	42	17.03	
8'	033591	42	18.16	
8' 6"	033592	42	19.30	
9'	033593	42	20.43	
10'	033595	42	22.70	
10' 6"	033596	42	23.84	

Call Your Master-Halco location for availability of domestic full weight pipe in cut posts.

Chain Link - Pipe and Tube



Domestic Full Weight (Schedule 40) • 2.0 oz. Galvanized Pipe

1-7/8" O.D. Domestic Full Weight Posts (Schedule 40) / 2 oz. • Meets ASTM F 1043 Group IA and F 1083 • Nominal wall thickness .145

DESCRIPTION	PART NO.	PIECES PER BUNDLE	WEIGHT EA.	NOTES
6'	033612	36	16.32	
7'	033614	36	19.04	
8'	033616	36	21.76	
8' 6"	033617	36	23.12	
9'	033618	36	24.48	
10'	033620	36	27.20	
10' 6"	033621	36	28.58	
11'	033622	36	29.92	
12'	033624	36	32.64	
13'	033626	36	35.36	
14'	033627	36	38.08	
15'	033628	36	40.80	

2-3/8" O.D. Domestic Full Weight Posts (Schedule 40) / 2 oz. Galvanized Pipe Meets ASTM F 1043 Group IA and F 1083 • Nominal wall thickness .154

DESCRIPTION	PART NO.	PIECES PER BUNDLE	WEIGHT EA.	NOTES
6'	033637	26	21.90	
7'	033639	26	25.55	
8'	033641	26	29.20	
8' 6"	033642	26	31.03	
9'	033643	26	32.85	
9' 6"	033644	26	34.88	
10'	033645	26	36.50	
10' 6"	033646	26	38.33	
11'	033647	26	40.15	
12'	033649	26	43.80	
13'	033651	26	47.45	
14'	033652	26	51.10	
15'	033653	26	54.75	

Call Your Master-Halco location for availability of domestic full weight pipe in cut posts.

2-7/8" O.D. Domestic Full Weight Posts (Schedule 40) / 2 oz. • Meets ASTM F 1043 Group IA and F 1083 • Nominal wall thickness .203

DESCRIPTION	PART NO.	PIECES PER BUNDLE	WEIGHT EA.	NOTES
6'	033662	18	34.74	
6' 6"	033663	18	37.64	
7'	033664	18	40.53	
7' 6"	033665	18	43.43	
8'	033666	18	46.32	
8' 6"	033667	18	49.22	
9'	033668	18	52.11	
10'	033670	18	57.90	
10' 6"	033671	18	60.80	
11'	033672	18	63.69	
11' 6"	033673	18	66.59	
12'	033674	18	69.48	
13'	033676	18	75.27	
14'	033677	18	81.06	
15'	033678	18	86.85	

4" O.D. Domestic Full Weight Posts (Schedule 40) / 2 oz. • Meets ASTM F 1043 Group IA and F 1083 • Nominal wall thickness .226

DESCRIPTION	PART NO.	PIECES PER BUNDLE	WEIGHT EA.	NOTES
6'	033687	12	54.66	
7'	033689	12	63.77	
8'	033691	12	72.88	
9'	033693	12	81.99	
10'	033695	12	91.10	
10' 6"	033696	12	95.65	
11'	033697	12	100.21	
12'	033699	12	109.32	
13'	033681	12	118.43	
14'	033682	12	127.54	
15'	033683	12	136.65	

Call Your Master-Halco location for availability of domestic full weight pipe in cut posts.

17 Gauge • Galvanized Tubing

Spectra 17 Gauge / Polyester • Nominal wall thickness .055

DESCRIPTION	PART NO.			21'	PIECES PER BUNDLE	WEIGHT PER FT.	NOTES
	10' 6" GREEN	10' 6" BLACK	10' 6" BROWN				
1-3/8" O.D. – SE	009410	009411	009412	66001_	91	.74	
1-3/8" O.D. – PE	066014	066015	066016	—	91	.74	

1-5/8" O.D. Posts 17 Gauge / Polyester • Nominal wall thickness .055

DESCRIPTION	PART NO.	PIECES PER BUNDLE	WEIGHT EA.	NOTES
5' 6"	67678_	61	4.75	
6'	63589_	61	5.70	
7'	63591_	61	6.63	
8'	63592_	61	7.60	

2-3/8" O.D. Posts 17 Gauge / Polyester • Nominal wall thickness .055

DESCRIPTION	PART NO.	PIECES PER BUNDLE	WEIGHT EA.	NOTES
6'	63601_	37	9.60	
7'	67677_	37	11.20	
8'	63604_	37	12.80	

Add the following number to the part no. for desired color:

1-Forest Green 2-Midnight Black 3-Sierra Brown

Spectra 16 Gauge / Polyester • Nominal wall thickness .065

DESCRIPTION	PART NO.				PIECES PER BUNDLE	WEIGHT PER FT.	NOTES
	10' 6"	21'	22'	24'			
1-3/8" O.D. - PE	65001_	65002_	—	—	91	.87	
1-3/8" O.D. - SE	65005_	65006_	—	—	91	.87	
1-5/8" O.D. - PE	65010_	65011_	—	65013_	61	1.10	
1-5/8" O.D. - SE	—	—	65012_	—	61	1.10	
1-7/8" O.D.	—	65015_	—	65017_	61	1.27	
2-3/8" O.D.	—	65019_	—	65021_	37	1.60	

1-5/8" O.D. Posts 16 Gauge / Polyester • Nominal wall thickness .065

DESCRIPTION	PART NO.	PIECES PER BUNDLE	WEIGHT EA.	NOTES
5'	65041_	61	5.55	
5' 6"	65042_	61	6.11	
6'	65043_	61	6.66	
6' 6"	65044_	61	7.22	
7'	65045_	61	7.77	
7' 6"	65046_	61	8.33	
8'	65047_	61	8.88	

1-7/8" O.D. Posts 16 Gauge / Polyester • Nominal wall thickness .065

DESCRIPTION	PART NO.	PIECES PER BUNDLE	WEIGHT EA.	NOTES
5'	65051_	61	6.35	
5' 6"	65052_	61	6.99	
6'	65053_	61	7.62	
6' 6"	65054_	61	8.62	
7'	65055_	61	8.89	
7' 6"	65056_	61	9.53	
8'	65057_	61	10.16	
9'	65058_	61	11.99	

Add the following number to the part no. for desired color:

1-Forest Green 2-Midnight Black 3-Sierra Brown

16 Gauge • Galvanized Tubing

2-3/8" O.D. Posts 16 Gauge / Polyester • Nominal wall thickness .065

DESCRIPTION	PART NO.	PIECES PER BUNDLE	WEIGHT EA.	NOTES
5'	65061_	37	8.00	
5' 6"	65062_	37	8.80	
6'	65063_	37	9.60	
7'	65065_	37	11.20	
8'	65067_	37	12.80	
9'	65070_	37	15.30	

Add the following number to the part no. for desired color:

1-Forest Green 2-Midnight Black 3-Sierra Brown

Spectra CQ 20 / Polyester

DESCRIPTION	PART NO.			PIECES PER BUNDLE	WEIGHT PER FT.	NOMINAL WALL THICKNESS	NOTES
	21'	22'	24'				
1-3/8" O.D. - SE	67503_	—	—	91	1.06	.080	
1-5/8" O.D. - PE	67510_	—	67516_	61	1.46	.085	
1-5/8" O.D. - SE	67513_	67515_	—	61	1.46	.085	
1-7/8" O.D.	67520_	—	67522_	61	1.75	.090	
2-3/8" O.D.	67530_	—	67532_	37	2.29	.095	
2-7/8" O.D.	67540_	—	67541_	19	3.25	.110	

1-5/8" O.D. CQ 20 Posts / Polyester • Nominal wall thickness .085

DESCRIPTION	PART NO.	PIECES PER BUNDLE	WEIGHT EA.	NOTES
6'	67554_	61	8.76	
7'	67556_	61	10.22	
8'	67558_	61	11.68	
9'	67559_	61	13.14	
10'	67560_	61	14.60	

1-7/8" O.D. CQ 20 Posts / Polyester • Nominal wall thickness .090

DESCRIPTION	PART NO.	PIECES PER BUNDLE	WEIGHT EA.	NOTES
6'	67564_	61	10.50	
7'	67566_	61	12.25	
8'	67568_	61	14.00	
8' 6"	67569_	61	14.87	
9'	67570_	61	15.75	
10'	67571_	61	17.50	

Add the following number to the part no. for desired color:

1-Forest Green 2-Midnight Black 3-Sierra Brown

Chain Link - Spectra® Pipe and Tube



CQ 20 • Galvanized Pipe

2-3/8" O.D. CQ 20 Posts / Polyester • Nominal wall thickness .095

DESCRIPTION	PART NO.	PIECES PER BUNDLE	WEIGHT EA.	NOTES
6'	67574_	37	13.80	
7'	67576_	37	16.10	
8'	67578_	37	18.40	
8'6"	67579_	37	19.55	
9'	67580_	37	20.70	
10'	67582_	37	23.00	
10'6"	67583_	37	24.15	
11'	67584_	37	25.30	
12'	67585_	37	27.60	
13'	67581_	37	29.90	

2-7/8" O.D. CQ 20 Posts / Polyester • Nominal wall thickness .110

DESCRIPTION	PART NO.	PIECES PER BUNDLE	WEIGHT EA.	NOTES
6'	67586_	19	19.50	
7'	67587_	19	22.75	
8'	67588_	19	26.00	
9'	67589_	19	29.25	
10'	67590_	19	32.50	
10'6"	67591_	19	34.13	
11'	67592_	19	37.75	
12'	67593_	19	39.00	
13'	67594_	19	42.25	

Add the following number to the part no. for desired color:

1-Forest Green 2-Midnight Black 3-Sierra Brown

CL-72

Spectra DQ 40 / Polyester • Meets ASTM F 1043 Group IC

DESCRIPTION	PART NO.			PIECES PER BUNDLE	WEIGHT PER FT.	NOMINAL WALL THICKNESS	NOTES
	18'	21'	24'				
1-5/8" O.D. - PE	—	69501_	69502_	61	1.83	.111	
1-7/8" O.D.	69509_	69510_	69511_	61	2.28	.120	
2-3/8" O.D.	69519_	69520_	69521_	37	3.12	.130	
2-7/8" O.D.	—	69530_	69531_	19	4.78	.149	
4" O.D.	—	69532_	69533_	19	6.60	.160	

1-5/8" O.D. DQ 40 Posts / Polyester • Meets ASTM F 1043 Group IC • Nominal wall thickness .111

DESCRIPTION	PART NO.	PIECES PER BUNDLE	WEIGHT EA.	NOTES
6' - Black	006717	61	10.98	
7'	69556_	61	13.00	
8'	69558_	61	14.64	
10 6" - Black	178N00	61	18.00	

1-7/8" O.D. DQ 40 Posts / Polyester • Meets ASTM F 1043 Group IC • Nominal wall thickness .120

DESCRIPTION	PART NO.	PIECES PER BUNDLE	WEIGHT EA.	NOTES
6'	69559_	61	13.50	
7'	69560_	61	15.75	
8'	69568_	61	18.00	
9'	69571_	61	20.25	
10'	69573_	61	22.50	
10 6"	69574_	61	23.63	

Add the following number to the part no. for desired color:

1-Forest Green 2-Midnight Black 3-Sierra Brown

Chain Link - Spectra® Pipe and Tube



DQ 40 • Galvanized Pipe

2-3/8" O.D. DQ 40 Posts / Polyester • Meets ASTM F 1043 Group IC • Nominal wall thickness .130

DESCRIPTION	PART NO.	PIECES PER BUNDLE	WEIGHT EA.	NOTES
6'	69575_	37	18.66	
7'	69569_	37	21.77	
8'	69578_	37	24.88	
8' 8"	69577_	37	26.44	
9'	69579_	37	27.99	
9' 8"	69595_	37	30.06	
10'	69580_	37	31.10	
10' 6"	69590_	37	32.66	
11'	69596_	37	34.21	
12'	69591_	37	37.32	
13'	69593_	37	40.43	
15'	69594_	37	46.65	

2-7/8" O.D. DQ 40 Posts / Polyester • Meets ASTM F 1043 Group IC • Nominal wall thickness .149

DESCRIPTION	PART NO.	PIECES PER BUNDLE	WEIGHT EA.	NOTES
6'	69537_	19	28.68	
7'	69563_	19	32.46	
8'	69581_	19	37.12	
9'	69582_	19	41.76	
10'	69583_	19	46.40	
10' 6"	69587_	19	48.72	
11'	69584_	19	51.04	
12'	69586_	19	55.68	
13'	69588_	19	60.32	
15'	69589_	19	69.60	

Add the following number to the part no. for desired color:
1-Forest Green 2-Midnight Black 3-Sierra Brown

CL-74

4" O.D. DQ 40 Posts / Polyester • Meets ASTM F 1043 Group IC • Nominal wall thickness .160

DESCRIPTION	PART NO.	PIECES PER BUNDLE	WEIGHT EA.	NOTES
7'	69606_	19	48.45	
8'	69605_	19	53.10	
9'	69602_	19	59.73	
10'	69601_	19	66.36	
10' 6"	69597_	19	69.00	
11'	69598_	19	73.00	
12'	69599_	19	79.00	
13'	69600_	19	85.58	
14'	69628_	19	92.91	
15'	69604_	19	99.00	
16'	69619_	19	106.18	

Add the following number to the part no. for desired color:

1-Forest Green 2-Midnight Black 3-Sierra Brown

Full Weight (Schedule 40) • Galvanized Pipe

Spectra Full Weight (Schedule 40) / Polyester • Meets ASTM F 1043

DESCRIPTION	PART NO.			PIECES PER BUNDLE	WEIGHT PER FT.	NOMINAL WALL THICKNESS	NOTES
	18'	21'	24'				
1-5/8" O.D. - PE	—	68552_	68031_	61	2.27	.140	
1-7/8" O.D. - PE	—	68714_	68716_	61	2.72	.145	
2-3/8" O.D.	—	69101_	69103_	37	3.65	.154	
2-7/8" O.D.	—	69310_	69312_	18	5.79	.203	
4" O.D.	69005_	68852_	68996_	12	9.11	.226	
6-5/8" O.D. - Black	—	484H00	696162	*	18.97	.280	

* NOTE: Not required to order in bundle quantities.

1-7/8" O.D. Full Weight Posts / Polyester • Meets ASTM F 1043 • Nominal wall thickness .145

DESCRIPTION	PART NO.	PIECES PER BUNDLE	WEIGHT EA.	NOTES
6'	68950_	61	16.32	
8'	68809_	61	21.76	
9'	68710_	61	25.00	
10'	68711_	61	27.20	
10 6"	68712_	61	27.20	

2-3/8" O.D. Full Weight Posts / Polyester • Meets ASTM F 1043 • Nominal wall thickness .154

DESCRIPTION	PART NO.	PIECES PER BUNDLE	WEIGHT EA.	NOTES
6'	68953_	37	21.90	
6'6"	68954_	37	23.73	
7'	68955_	37	25.50	
7'6"	68956_	37	27.38	
8'	68957_	37	29.20	
9'	69112_	37	32.85	
10'	69125_	37	36.50	
10'6"	68960_	37	38.33	
11' - Black	007620	37	40.15	
12'	68961_	37	43.80	
12'8"	68962_	37	45.63	

Add the following number to the part no. for desired color:

1-Forest Green 2-Midnight Black 3-Sierra Brown

2-7/8" O.D. Full Weight Posts / Polyester • Meets ASTM F 1043 • Nominal wall thickness .203

DESCRIPTION	PART NO.	PIECES PER BUNDLE	WEIGHT EA.	NOTES
7'	68964_	18	40.53	
8'	68553_	18	46.32	
9'	69338_	18	52.11	
10'	68966_	18	57.90	
10' 6"	68968_	18	60.80	
11'	68967_	18	63.69	
12'	69340_	18	69.48	

4" O.D. Full Weight Posts / Polyester • Meets ASTM F 1043 • Nominal wall thickness .226

DESCRIPTION	PART NO.	PIECES PER BUNDLE	WEIGHT EA.	NOTES
8'	68554_	12	72.80	
9'	67674_	12	84.00	
10' - Black	385C00	12	91.00	
11' - Black	508E00	12	100.21	
12' - Black	006686	12	109.20	
14'	67686_	12	127.40	

6-5/8" O.D. Full Weight Posts / Polyester • Meets ASTM F 1043 • Nominal wall thickness .280

DESCRIPTION	PART NO.	PIECES PER BUNDLE	WEIGHT EA.	NOTES
7' - Black	937X00	*	132.80	
8' - Black	696182	*	151.76	
9' - Black	688102	*	170.73	
10' - Black	704O00	*	189.70	
10' 6" - Black	549A00	*	199.10	
11' - Black	588U00	*	208.67	
12' - Black	696222	*	227.64	
16' - Black	695352	*	303.52	

* **NOTE:** Not required to order in bundle quantities.

Add the following number to the part no. for desired color:
1-Forest Green 2-Midnight Black 3-Sierra Brown

Chain Link - Heavy Mil Pipe and Tube



DQ 40 • Galvanized Pipe

Heavy Mil DQ 40 / Meets ASTM F 1043 Group IC

DESCRIPTION	PART NO.			PIECES PER BUNDLE	WEIGHT PER FT.	NOMINAL WALL THICKNESS	NOTES
	18'	21'	24'				
1-5/8" O.D. - PE	—	48167_	—	61	1.83	.111	
1-7/8" O.D. - PE	48168_	48169_	48170_	61	2.28	.120	
2-3/8" O.D.	—	48172_	48173_	37	3.12	.130	
2-7/8" O.D.	—	48174_	48175_	19	4.78	.149	
4" O.D.	—	48176_	48177_	19	6.60	.160	

1-7/8" O.D. DQ 40 Posts / Meets ASTM F 1043 Group IC • Nominal wall thickness .120

DESCRIPTION	PART NO.	PIECES PER BUNDLE	WEIGHT EA.	NOTES
6'	48533_	61	13.50	
7'	48534_	61	15.75	
8'	48370_	61	18.00	
8' 8"	48371_	61	19.13	
9'	48372_	61	20.25	
9' 8"	48373_	61	21.75	
10'	48374_	61	22.50	
10' 6"	48375_	61	23.63	

2-3/8" O.D. DQ 40 Posts / Meets ASTM F 1043 Group IC • Nominal wall thickness .130

DESCRIPTION	PART NO.	PIECES PER BUNDLE	WEIGHT EA.	NOTES
6'	48368_	37	18.66	
7'	48369_	37	21.77	
8'	48376_	37	24.88	
8' 8"	48377_	37	26.44	
9'	48378_	37	27.99	
10'	48380_	37	31.10	
10' 6"	48381_	37	32.66	
11'	48382_	37	34.21	
12'	48383_	37	37.32	
13'	48384_	37	40.43	
15'	48385_	37	46.65	

Add the following number to the part no. for desired color:

1-Forest Green 2-Midnight Black 3-Sierra Brown

CL-78

2-7/8" O.D. DQ 40 Posts / Meets ASTM F 1043 Group IC • Nominal wall thickness .149

DESCRIPTION	PART NO.	PIECES PER BUNDLE	WEIGHT EA.	NOTES
8'	48366_	19	37.12	
9'	48367_	19	41.76	
10'	48386_	19	46.40	
10' 6"	48387_	19	48.72	
11'	48388_	19	51.04	
12'	48389_	19	55.68	
13'	48390_	19	60.32	
15'	48391_	19	69.60	

4" O.D. DQ 40 Posts / Meets ASTM F 1043 Group IC • Nominal wall thickness .160

DESCRIPTION	PART NO.	PIECES PER BUNDLE	WEIGHT EA.	NOTES
8'	50368_	19	52.00	
9' - Black	299F00	19	59.40	
10' 6"	48392_	19	68.88	
11'	48393_	19	72.16	
12'	48394_	19	78.72	
13'	48395_	19	85.28	

Add the following number to the part no. for desired color:

1-Forest Green 2-Midnight Black 3-Sierra Brown

Chain Link - Heavy Mil Pipe and Tube



Full Weight (Schedule 40) • Galvanized Pipe

Heavy Mil Full Weight (Schedule 40)

DESCRIPTION	18'	PART NO. 21'	24'	PIECES PER BUNDLE	WEIGHT PER FT.	NOMINAL WALL THICKNESS	NOTES
1-5/8" O.D. - PE	—	48178_	—	42	2.27	.140	
1-7/8" O.D. - PE	48179_	48180_	48181_	36	2.72	.145	
2-3/8" O.D.	48182_	48183_	48184_	26	3.65	.154	
2-7/8" O.D.	48185_	48186_	48187_	18	5.79	.203	
4" O.D.	—	48189_	48190_	12	9.10	.226	
6-5/8" O.D.	—	48192_	48193_	*	18.97	.280	

* NOTE: Not required to order in bundle quantities.

1-7/8" Full Weight Posts (Schedule 40) / Nominal wall thickness .145

DESCRIPTION	PART NO.	PIECES PER BUNDLE	WEIGHT EA.	NOTES
6'	48299_	36	16.32	
7'	48301_	36	19.04	
8'	48300_	36	21.76	
8' 8"	48302_	36	23.12	
9'	48304_	36	24.48	
9' 8"	48306_	36	25.84	
10'	48308_	36	27.20	
10' 6"	48310_	36	29.01	

2-3/8" O.D. Full Weight Posts (Schedule 40) / Nominal wall thickness .154

DESCRIPTION	PART NO.	PIECES PER BUNDLE	WEIGHT EA.	NOTES
6'	48311_	26	21.90	
7'	48313_	26	25.55	
8'	48312_	26	29.20	
8' 8"	48314_	26	31.65	
9'	48316_	26	32.85	
9' 8"	48318_	26	35.28	
10'	48320_	26	36.50	
10' 6"	48322_	26	38.33	
11'	48324_	26	40.15	
12'	48326_	26	43.80	
13'	48328_	26	47.45	
15'	48330_	26	54.75	

Add the following number to the part no. for desired color:

1-Forest Green 2-Midnight Black 3-Sierra Brown

CL-80

2-7/8" O.D. Full Weight Posts (Schedule 40) / Nominal wall thickness .203

DESCRIPTION	PART NO.	PIECES PER BUNDLE	WEIGHT EA.	NOTES
8'	48331_	18	46.32	
9'	48333_	18	52.11	
10'	48332_	18	57.90	
10' 6"	48334_	18	60.80	
11'	48336_	18	63.69	
12'	48338_	18	69.48	
13'	48340_	18	75.27	
15'	48342_	18	86.85	

4" O.D. Full Weight Posts (Schedule 40) / Nominal wall thickness .226

DESCRIPTION	PART NO.	PIECES PER BUNDLE	WEIGHT EA.	NOTES
10'	48344_	12	91.00	
10' 6"	48346_	12	95.55	
11'	48348_	12	100.10	
12'	48350_	12	109.20	
13'	48351_	12	118.30	
15'	48353_	12	136.50	

6-5/8" O.D. Full Weight Posts (Schedule 40) / Nominal wall thickness .280

DESCRIPTION	PART NO.	PIECES PER BUNDLE	WEIGHT EA.	NOTES
10'	48352_	*	189.70	
10' 6"	48354_	*	199.10	
11'	48356_	*	208.67	
12'	48358_	*	227.64	
13'	48360_	*	246.61	
15'	48361_	*	284.55	

* **NOTE:** Not required to order in bundle quantities.

Add the following number to the part no. for desired color:

1-Forest Green 2-Midnight Black 3-Sierra Brown

Regular Tension Bands / 14 ga. x 3/4" Pressed Steel – Galvanized

DESCRIPTION	PART NO.	PER SACK	WEIGHT EA.	NOTES
1-3/8"	010101	250	.12	
1-5/8"	010102	250	.14	
1-7/8"	010103	250	.15	
2-3/8"	010104	250	.18	
2-7/8"	010105	100	.20	
3" Full	010106	100	.21	
3-1/2"	010107	100	.23	
4"	010108	100	.24	
4-1/2"	010109	100	.30	

Use 5/16" x 1-1/4" Carriage Bolt – Pt. #010701

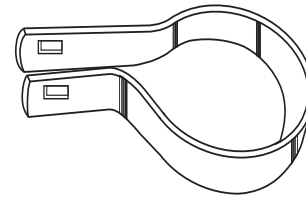

Medium Tension Bands / 12 ga. x 7/8" Pressed Steel – Galvanized

DESCRIPTION	PART NO.	PER SACK	WEIGHT EA.	NOTES
1-3/8"	010551	200	.21	
1-5/8"	010552	200	.25	
1-7/8"	010553	200	.26	
2-3/8"	010554	200	.31	
2-7/8"	010555	100	.35	
3-1/2"	010557	100	.41	
4"	010558	100	.46	
4-1/2"	010559	100	.52	
6-5/8"	010560	50	.68	

Use 5/16" x 1-1/4" Carriage Bolt – Pt. #010701

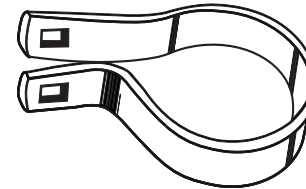

Beveled Tension Bands / 12 ga. x 7/8" Pressed Steel – Galvanized

DESCRIPTION	PART NO.	PER SACK	WEIGHT EA.	NOTES
1-3/8"	010251	250	.19	
1-5/8"	010252	250	.21	
1-7/8"	010253	250	.22	
2-3/8"	010254	250	.26	
2-7/8"	010255	100	.34	
4"	010258	100	.38	
6-5/8"	010260	50	.56	
8-5/8"	010261	50	.84	

Use 5/16" x 1-1/4" Carriage Bolt – Pt. #010701

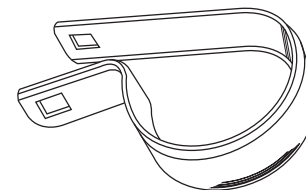

Heavy Tension Bands / 1/8" x 1" Pressed Steel – Galvanized

DESCRIPTION	PART NO.	PER SACK	WEIGHT EA.	NOTES
1-3/8"	010201	250	.26	
1-5/8"	010202	250	.30	
1-7/8"	010203	100	.33	
2-3/8"	010204	100	.39	
2-7/8"	010205	100	.42	
3-1/2"	010207	100	.50	
4"	010208	50	.59	
4-1/2"	010209	50	.66	
6-5/8"	010210	50	.85	
8-5/8"	010211	50	1.10	

Use 3/8" x 1-1/2" Carriage Bolt – Pt. #010704

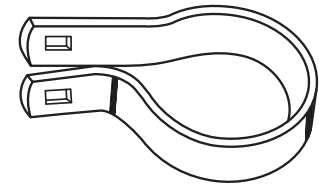

Snappy Tension Band / Pressed Steel – Galvanized with Aluminum Fastener

DESCRIPTION	PART NO.	PER SACK	WEIGHT EA.	NOTES
1-3/8"	010121	100	.10	

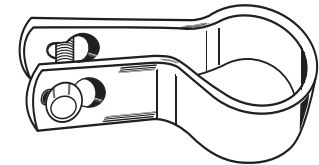

Boltless Tension Band / Aluminum

DESCRIPTION	PART NO.	PER SACK	WEIGHT EA.	NOTES
2-3/8"	010164	250	.06	

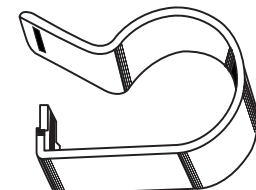

Regular Brace Bands / 12 ga. x 3/4" Pressed Steel – Galvanized

DESCRIPTION	PART NO.	PER SACK	WEIGHT EA.	NOTES
1-3/8"	010301	250	.13	
1-5/8"	010302	250	.15	
1-7/8"	010303	250	.18	
2-3/8"	010304	250	.21	
2-7/8"	010305	100	.24	
3" Full	010306	100	.25	
3-1/2"	010307	100	.30	
4"	010308	100	.34	
4-1/2"	010309	100	.36	

Use 5/16" x 1-1/4" Carriage Bolt – Pt. #010701

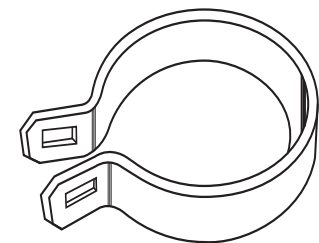

Medium Brace Bands / 12 ga. x 7/8" Pressed Steel – Galvanized

DESCRIPTION	PART NO.	PER SACK	WEIGHT EA.	NOTES
1-3/8"	010651	250	.17	
1-5/8"	010652	250	.19	
1-7/8"	010653	250	.21	
2-3/8"	010654	250	.24	
2-7/8"	010655	100	.29	
3-1/2"	010657	100	.33	
4"	010658	100	.38	
4-1/2"	010659	100	.45	
6-5/8"	010660	50	.65	

Use 5/16" x 1-1/4" Carriage Bolt – Pt. #010701

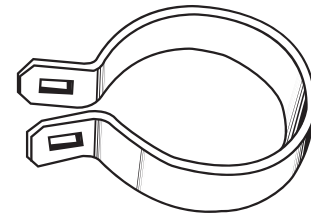

Beveled Brace Bands / 12 ga. x 7/8" Pressed Steel – Galvanized

DESCRIPTION	PART NO.	PER SACK	WEIGHT EA.	NOTES
1-5/8"	010453	300	.20	
1-7/8"	010453	250	.22	
2-3/8"	010454	250	.25	
2-7/8"	010455	100	.33	
4"	010458	100	.41	
6-5/8"	010460	50	.76	
8-5/8"	010461	50	.80	

Use 5/16" x 1-1/4" Carriage Bolt – Pt. #010701

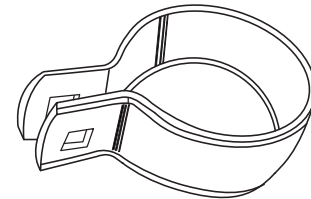

Heavy Brace Bands / 1/8" x 1" Pressed Steel – Galvanized

DESCRIPTION	PART NO.	PER SACK	WEIGHT EA.	NOTES
1-3/8"	010401	250	.20	
1-5/8"	010402	250	.25	
1-7/8"	010403	100	.26	
2-3/8"	010404	100	.32	
2-7/8"	010405	100	.36	
3-1/2"	010407	100	.44	
4"	010408	50	.49	
4-1/2"	010409	50	.55	
6-5/8"	010410	50	.77	
8-5/8"	010411	50	1.02	
Sr. H	010413	100	.35	

Use 3/8" x 1-1/2" Carriage Bolt – Pt. #010704

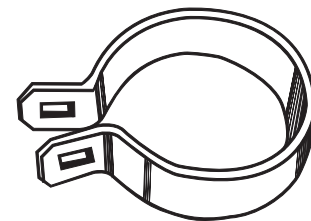

Regular 2-Way Brace Bands / Pressed Steel – Galvanized

Heavy 1/8" x 1" available on special quotation

DESCRIPTION	PART NO.	PER SACK	WEIGHT EA.	NOTES
1-7/8" 90° 2-way	010310	100	.19	
1-7/8" 180° 2-way	010311	100	.21	
2-3/8" 90° 2-way	010313	100	.21	
2-3/8" 180° 2-way	010314	100	.25	
2-7/8" 180° 2-way	010320	100	.29	

Use 5/16" x 1-1/4" Carriage Bolt – Pt. #010701

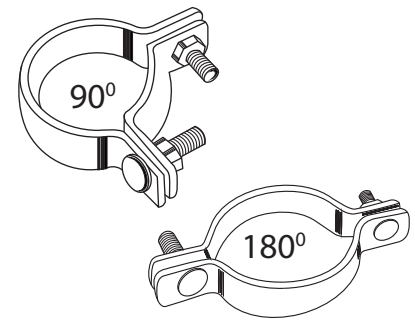

Ratchet For Barb Wire / Galvanized – Steel

DESCRIPTION	PART NO.	PER SACK	WEIGHT EA.	NOTES
Universal	010515	25	.57	

NOTE: Use with one 1/8" x 1" Brace Band (sold separately).

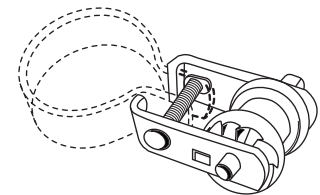

Step-Up Adapter / Pressed Steel – Galvanized

DESCRIPTION	PART NO.	PER SACK	WEIGHT EA.	NOTES
1" x 3-1/2"	018611	250	.12	

NOTE: Use with one Brace Band and Rail End (sold separately) to create an offset allowing a third rail joining at corner to be evenly aligned.

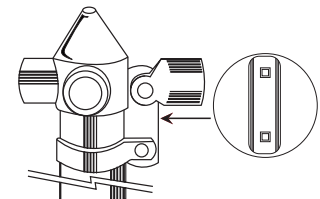

Backstop Adapter

DESCRIPTION	PART NO.	PER SACK	WEIGHT EA.	NOTES
Malleable Iron – Galvanized	015925	15	4.9	

Post: Fits inside 4" O.D. Pipe or over 2-7/8" O.D. Pipe.

Extension: Fits inside 2-7/8" O.D. Pipe or over 1-7/8" O.D. Pipe.

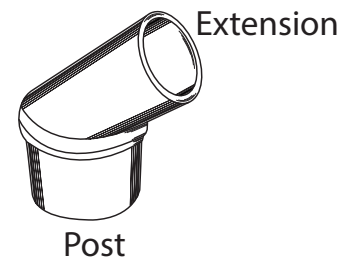

Concave Adapter / Die-Cast Aluminum

DESCRIPTION	PART NO.	PER SACK	WEIGHT EA.	NOTES
Concave Adapter	011928	200	.06	

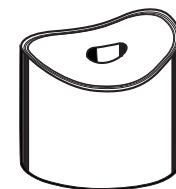

Caps, Heavy / Die-Cast Aluminum

DESCRIPTION	PART NO.	PER SACK	WEIGHT EA.	NOTES
1-3/8"	011301	350	.06	
1-5/8"	011302	350	.09	
1-7/8"	011303	250	.10	
2-3/8"	011304	150	.14	
2-7/8"	011315	150	.20	
3-1/2"	011316	150	.20	
4"	011317	50	.22	
4-1/2"	011313	4	.56	
6-5/8"	011319	4	.56	

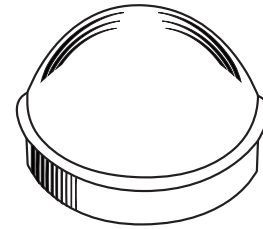

Acorn Caps / Die-Cast Aluminum

DESCRIPTION	PART NO.	PER SACK	WEIGHT EA.	NOTES
1-3/8"	011321	350	.08	
1-5/8"	011322	350	.13	
1-7/8"	011323	250	.16	
2-3/8"	011324	150	.25	
2-7/8"	011325	100	.37	

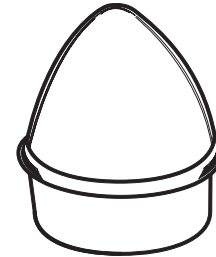

Caps / Pressed Steel - Galvanized

DESCRIPTION	PART NO.	PER SACK	WEIGHT EA.	NOTES
1-3/8"	011601	250	.10	
1-5/8"	011602	250	.13	
1-7/8"	011603	200	.16	
2-3/8"	011604	125	.23	
2-7/8"	011605	100	.31	
3" Full	011606	125	.42	
3-1/2"	011607	25	.49	
4"	011608	25	.59	
4-1/2"	011609	25	.89	
6-5/8"	011610	10	1.44	
8-5/8"	414W00	10	2.00	

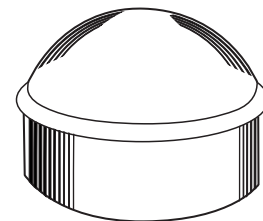

Dura Caps / Pressed Steel – Galvanized

DESCRIPTION	PART NO.	PER SACK	WEIGHT EA.	NOTES
1-7/8"	012715	100	.13	
2-3/8"	012716	100	.19	
2-7/8"	012717	50	.25	
4"	012718	25	.43	
6-5/8"	012719	10	.96	

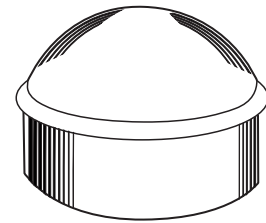

Caps / Cast Iron – Galvanized

DESCRIPTION	PART NO.	PER SACK	WEIGHT EA.	NOTES
4"	011808	25	1.50	
6-5/8"	011811	6	7.39	

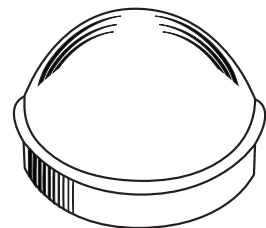

Bullet Caps / Die-Cast Aluminum

DESCRIPTION	PART NO.	PER SACK	WEIGHT EA.	NOTES
2-3/8"	011360	100	.22	

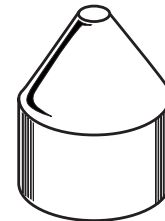

One-Way Bullet Caps / Die-Cast Aluminum

DESCRIPTION	PART NO.	PER SACK	WEIGHT EA.	NOTES
1-7/8"	011351	100	.22	
2-3/8"	011361	100	.28	

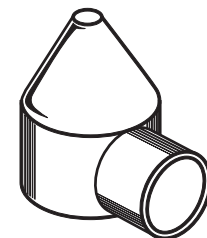

Two-Way Bullet Caps / Die-Cast Aluminum

DESCRIPTION	PART NO.	PER SACK	WEIGHT EA.	NOTES
1-7/8"	011352	100	.26	
2-3/8"	011362	100	.31	

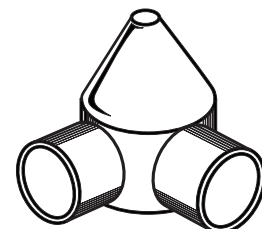

Eye Tops / Die-Cast Aluminum

DESCRIPTION	PART NO.	PER SACK	WEIGHT EA.	NOTES
1-5/8" x 1-3/8"	011901	200	.11	
1-7/8" x 1-3/8"	011902	100	.16	
1-7/8" x 1-5/8"	011903	100	.17	
2-3/8" x 1-5/8"	011904	100	.19	

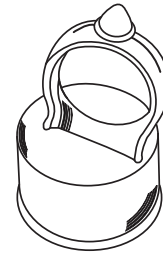

Eye Tops - Dura Top / Pressed Steel - Galvanized

DESCRIPTION	PART NO.	PER SACK	WEIGHT EA.	NOTES
1-5/8" x 1-3/8"	012250	100	.20	
1-7/8" x 1-3/8"	012251	100	.23	
1-7/8" x 1-5/8"	012260	100	.25	
1-7/8" x 1-5/8"	012710	100	.39	
2-3/8" x 1-5/8"	012711	100	.49	

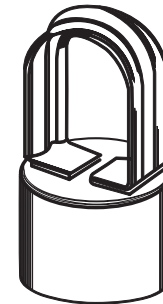

Eye Tops - Standard / Pressed Steel - Galvanized

DESCRIPTION	PART NO.	PER SACK	WEIGHT EA.	NOTES
1-5/8" x 1-5/8"	012252	100	.51	
1-7/8" x 1-5/8"	012253	100	.53	
2-3/8" x 1-5/8"	012254	50	.64	
2-7/8" x 1-5/8"	012255	50	1.02	
4" x 1-5/8"	012259	25	1.22	

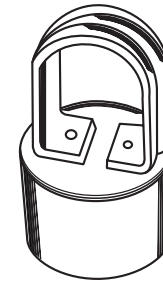

Eye Tops / Cast Iron - Galvanized

DESCRIPTION	PART NO.	PER SACK	WEIGHT EA.	NOTES
1-7/8" x 1-3/8"	012202	50	.96	
1-7/8" x 1-5/8"	012203	50	1.12	
2-3/8" x 1-5/8"	012204	25	1.45	
2-7/8" x 1-5/8"	012205	25	2.40	
4" x 1-5/8"	012210	20	4.18	

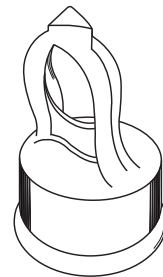

Barb Bases / Pressed Steel – Galvanized

DESCRIPTION	PART NO.	PER SACK	WEIGHT EA.	NOTES
1-5/8" x 1-5/8"	012881	50	.71	
1-7/8" x 1-5/8"	012882	50	.74	
2-3/8" x 1-5/8"	012883	50	.87	
2-7/8" x 1-5/8"	012884	25	1.26	

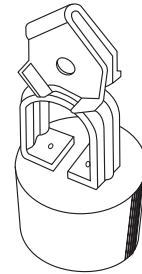

Extension Arms / Pressed Steel – Galvanized

DESCRIPTION	PART NO.	PER SACK	WEIGHT EA.	NOTES
With S Slot	013103	50	.89	
S Slot Notched for V-Arm	013104	50	.75	

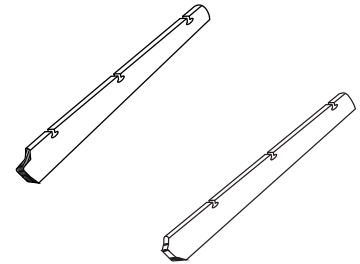

Holding Bracket For Extension Arm / Pressed Steel – Galvanized

DESCRIPTION	PART NO.	PER SACK	WEIGHT EA.	NOTES
Universal	013125	50	.24	

NOTE: Use with one 1/8" x 1" Brace Band (sold separately).

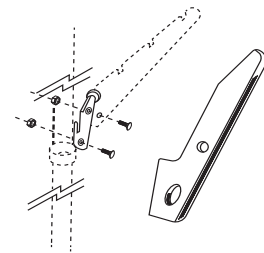

Barb Wire Arms Upright / Pressed Steel – Galvanized

DESCRIPTION	PART NO.	PER SACK	WEIGHT EA.	NOTES
1-7/8" x 1-5/8"	013123	25	1.50	
2-3/8" x 1-5/8"	013124	25	1.60	



Barb Wire Arms 45° / One-Piece Line Arm • Pressed Steel – Galvanized

DESCRIPTION	PART NO.	PER SACK	WEIGHT EA.	NOTES
1-5/8" x 1-5/8"	013107	25	1.65	
1-7/8" x 1-5/8"	013108	25	1.70	
2-3/8" x 1-5/8"	013109	25	1.80	
2-7/8" x 1-5/8"	013129	25	1.84	
4" x 1-5/8"	013141	25	2.60	
6-5/8" x 1-5/8"	005246	25	6.20	

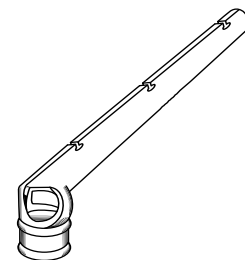

Barb Wire V-Arms / One-Piece Line Arm 6-Strand • Pressed Steel – Galvanized

DESCRIPTION	PART NO.	PER SACK	WEIGHT EA.	NOTES
1-7/8" x 1-5/8"	013121	15	2.17	
2-3/8" x 1-5/8"	013122	15	2.28	
2-7/8" x 1-5/8"	013126	15	3.00	

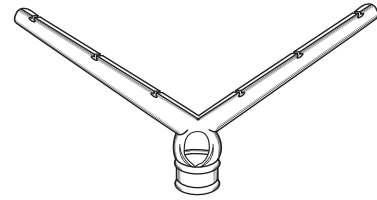

Corner Arms 45° / Pressed Steel – Galvanized

DESCRIPTION	PART NO.	PER SACK	WEIGHT EA.	NOTES
2-3/8"	013380	5	3.20	
2-7/8"	013381	5	3.50	
3-1/2"	013382	5	5.25	
4"	013383	5	5.50	

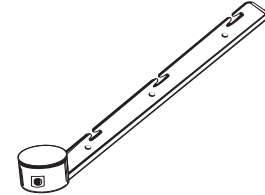

Corner V-Arms / 6 - Strand • Pressed Steel – Galvanized

DESCRIPTION	PART NO.	PER SACK	WEIGHT EA.	NOTES
2-3/8"	013390	5	6.00	
2-7/8"	013391	5	6.30	
3-1/2"	036318	5	6.68	
4"	013392	5	10.60	

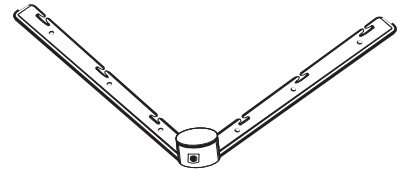

Corner Arms 45° / Malleable Iron – Galvanized

DESCRIPTION	PART NO.	PER SACK	WEIGHT EA.	NOTES
2-3/8"	013301	5	3.48	
2-7/8"	013302	5	4.46	
4"	013310	5	5.40	

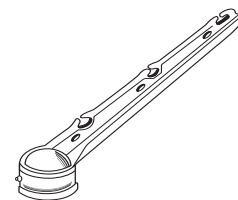

Corner V-Arms / 6 - Strand • Malleable Iron – Galvanized

DESCRIPTION	PART NO.	PER SACK	WEIGHT EA.	NOTES
2-3/8"	013304	5	4.93	
2-7/8"	013305	5	6.63	
4"	013311	5	7.20	

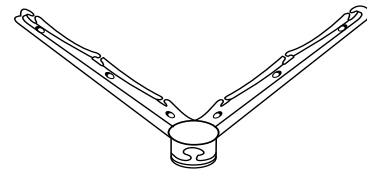

E-Z Aluminum Ties

DESCRIPTION	PART NO.	PER CASE	CASE WEIGHT	NOTES
(1-5/8") 6", 11 ga.	023524	3500	31.00	
(1-7/8") 6-1/2", 9 ga.	023526	2400	32.00	
(2-3/8") 8-1/4", 9 ga.	023527	1700	28.00	
(1-7/8") 6-1/2", 6 ga.	023522	2400	43.20	
(2-3/8") 8-1/4", 6 ga.	023523	1700	34.00	

NOTE: Sold only in full bags of 100 pieces.



Aluminum Ties

DESCRIPTION	PART NO.	PER CASE	CASE WEIGHT	NOTES
(1-7/8") 6-1/2", 11 ga. No. 33	023555	5600	50.00	
(1-7/8") 6-1/2", 11 ga. UPC	087036	30/BG	50.00	
(1-7/8") 6-1/2", 9 ga. No. 13	023552	3700	47.00	
(2-3/8") 8-1/4", 9 ga. No. 16	023553	3100	48.00	
(2-7/8") 10-1/2", 9 ga.	023558	2000	39.40	
(4") 12-1/2", 9 ga.	023561	2000	39.40	
(6-5/8") 14", 9 ga.	023564	1200	48.00	
(1-7/8") 6-1/2", 6 ga. No. 23	023559	1000	18.00	
(2-3/8") 8-1/4", 6 ga. No. 26	023560	2400	48.00	
(4") 12-1/2", 6 ga.	023563	500	12.50	

NOTE: Sold only in full bags of 100 pieces.

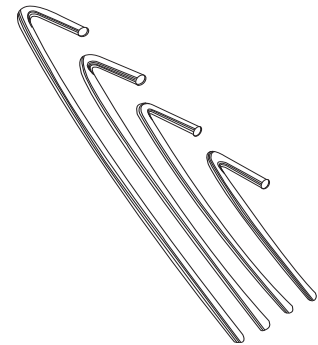

E-Z Twist Ties / 1.2 oz Steel

DESCRIPTION	PART NO.	CASE WEIGHT PER 500	CASE WEIGHT PER 1000	NOTES
(1-3/8") 11 ga.	026Y00	13.00	26.00	
(1-5/8") 11 ga.	468D00	15.00	30.00	
(1-7/8") 11 ga.	469D00	16.00	31.00	
(2-3/8") 11 ga.	470D00	19.00	37.00	
(2-7/8") 11 ga.	471D00	21.00	42.00	
(1-5/8") 9 ga.	002178	24.00	48.00	
(1-7/8") 9 ga.	002179	26.00	50.00	
(2-3/8") 9 ga.	023567	29.00	56.00	
(2-7/8") 9 ga.	002229	33.00	—	
(4") 9 ga.	583W00	43.00	—	
E-Z Twist Tie Tool - 11 gauge	475D00	1.00/ea	—	
E-Z Twist Tie Tool - 9 gauge	070260	1.00/ea	—	

NOTE: Sold only in full boxes.

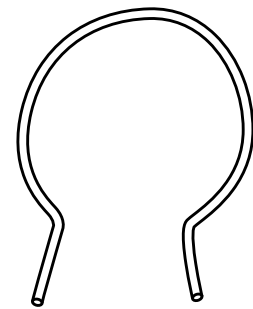

Galvanized Steel Ties / Class 3 • Meets ASTM F 626

DESCRIPTION	PART NO.	PER CASE	CASE WEIGHT	NOTES
(1-3/8") 6" 12 ga. .80	023571	2000	34.58	
(1-5/8") 6-1/2" 12 ga. .80	023572	2000	34.58	
(1-7/8") 7-1/2" 12 ga. .80	023573	2000	41.98	
(2-3/8") 8-1/2" 12 ga. .80	023574	2000	46.92	
(2-7/8") 10-1/2" 12 ga. .80	023576	2000	57.96	
(1-7/8") 7-1/2" 9 ga. .90	023583	1000	41.38	
(2-3/8") 8-1/2" 9 ga. .90	023584	1000	46.36	

NOTE: Sold only in full bags of 100 pieces.

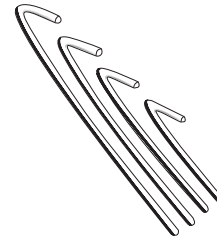

Steel Security Ties / .90 Zinc Coating • Meets ASTM F 626

DESCRIPTION	PART NO.	PER CASE	CASE WEIGHT	NOTES
(1-5/8") 6-1/2" 9 ga.	011224	2000	15.00	
(1-7/8") 7-1/2" 9 ga.	002213	2000	16.00	
(2-3/8") 8-1/2" 9 ga.	011225	2000	17.00	
(2-7/8") 10-1/2" 9 ga.	004772	2000	18.00	
(4") 14" 9 ga.	004797	1000	19.00	
Security Tie Tool - 9 gauge	011223	NA	1.00/ea	

NOTE: Sold only in full bags of 100 pieces.

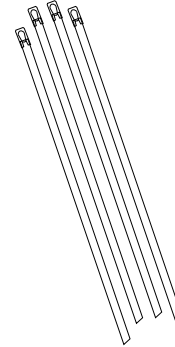

Galvanized Steel Ties – Straight / Class 3 .80 Zinc Coating • Meets ASTM F 626

DESCRIPTION	PART NO.	PER CASE	CASE WEIGHT	NOTES/REEL
(1-3/8") 7" 12 ga.	023586	2900	50.00	
(1-5/8") 7-1/2" 12 ga.	023585	2700	50.00	
(1-7/8") 8-1/2" 12 ga.	023587	2400	50.00	

NOTE: Sold only in full cases of 50 lbs. Priced per pound. Counts are approximate.



Rail Ends / Die-Cast Aluminum

DESCRIPTION	PART NO.	PER SACK	WEIGHT EA.	NOTES
1-3/8"	012301	500	.10	
1-5/8"	012302	250	.16	

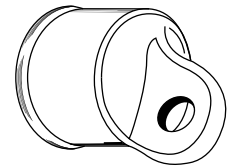

Rail Ends / Pressed Steel – Galvanized

DESCRIPTION	PART NO.	PER SACK	WEIGHT EA.	NOTES
1-3/8"	012515	100	.21	
1-5/8"	012506	100	.33	
1-7/8"	012508	50	.39	
2-3/8"	012510	50	.49	
2-7/8"	436A00	50	.59	
3-1/2"	000F99	50	1.00	

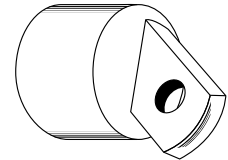

Dura Rail End / Pressed Steel – Galvanized

DESCRIPTION	PART NO.	PER SACK	WEIGHT EA.	NOTES
1-5/8"	012712	100	.28	

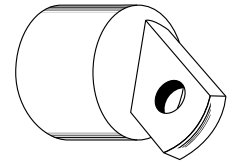

Rail Ends 2-Hole / Pressed Steel – Galvanized

DESCRIPTION	PART NO.	PER SACK	WEIGHT EA.	NOTES
1-5/8"	012507	100	.48	
1-7/8"	012509	50	.51	

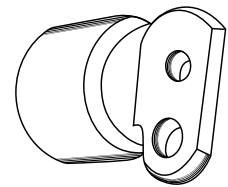

Dura Rail End 2-Hole / Pressed Steel – Galvanized

DESCRIPTION	PART NO.	PER SACK	WEIGHT EA.	NOTES
1-5/8"	012713	100	.36	

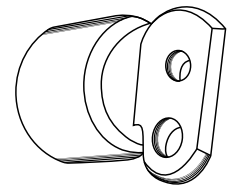

Combo Rail End / Pressed Steel – Galvanized

DESCRIPTION	PART NO.	PER SACK	WEIGHT EA.	NOTES
1-5/8"	012511	100	.35	

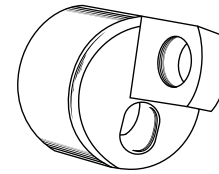

Dura Combo Rail End / Pressed Steel – Galvanized

DESCRIPTION	PART NO.	PER SACK	WEIGHT EA.	NOTES
1-5/8"	012714	100	.22	

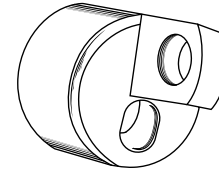

Combo Rail End / Malleable Iron – Galvanized

DESCRIPTION	PART NO.	PER SACK	WEIGHT EA.	NOTES
1-5/8"	012518	100	.43	

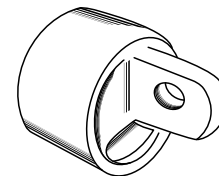

Brace or End Rail Clamps / Pressed Steel – Galvanized

Sizes: post first - rail second.

DESCRIPTION	PART NO.	PER SACK	WEIGHT EA.	NOTES
1-3/8" x 1-3/8"	015501	100	.32	
1-5/8" x 1-3/8"	015502	100	.45	
1-7/8" x 1-3/8"	015506	100	.50	
2-3/8" x 1-3/8"	015507	100	.50	
Use 5/16" x 2" Carriage Bolt – Pt. #010715				
1-5/8" x 1-5/8"	015503	100	.50	
1-7/8" x 1-5/8"	015504	100	.54	
2-3/8" x 1-5/8"	015505	50	.65	
2-7/8" x 1-5/8"	015508	50	.76	
4" x 1-5/8"	015509	50	.88	

Use 5/16" x 2-1/4" Carriage Bolt – Pt. #010716

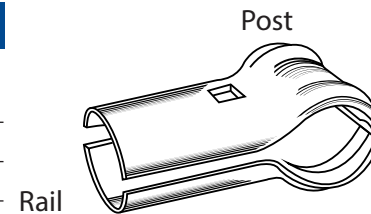

Heavy Brace or End Rail Clamps / Pressed Steel – Galvanized

3/16" Wall Thickness • Sizes: post first - rail second.

DESCRIPTION	PART NO.	PER SACK	WEIGHT EA.	NOTES
2-1/2" x 1-5/8"	220C00	100	1.51	
3" x 1-5/8"	218C00	100	1.66	
4" x 1-5/8"	898B00	100	2.20	

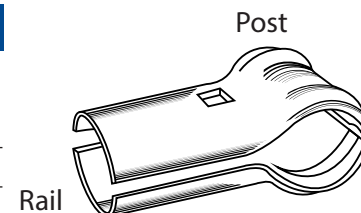

Line Rail Clamps / Pressed Steel – Galvanized

Sizes: post first - rail second.

DESCRIPTION	PART NO.	PER SACK	WEIGHT EA.	NOTES
1-3/8" x 1-3/8"	015530	50	.56	
1-5/8" x 1-3/8"	015531	50	.58	
1-7/8" x 1-3/8"	015532	50	.72	
2-3/8" x 1-3/8"	015533	50	.75	
Use 5/16" x 2" Carriage Bolt – Pt. #010715				
1-5/8" x 1-5/8"	015534	50	.60	
1-7/8" x 1-5/8"	015535	50	.73	
2-3/8" x 1-5/8"	015536	50	.80	
2-7/8" x 1-5/8"	015538	50	1.00	
4" x 1-5/8"	015540	50	1.06	
Use 5/16" x 2-1/2" Carriage Bolt – Pt. #010718				
1-7/8" x 1-7/8"	015537	50	.74	
Use 5/16" x 2-1/2" Carriage Bolt – Pt. #010718				

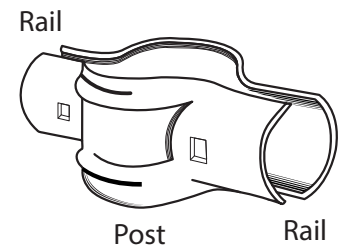

Heavy Line Rail Clamps / Pressed Steel – Galvanized

3/16" Wall Thickness • Sizes: post first - rail second.

DESCRIPTION	PART NO.	PER SACK	WEIGHT EA.	NOTES
1-7/8" x 1-5/8"	331H00	50	.56	
2-7/8" x 1-5/8"	629C00	50	.58	
3-1/2" x 1-5/8"	220H00	50	.72	
4" x 1-5/8"	897B00	50	.75	
Use 5/16" x 2-1/2" Carriage Bolt – Pt. # 010718				

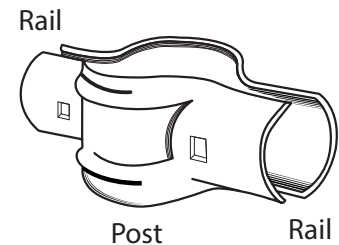

Corner Rail Clamps / Pressed Steel – Galvanized

Sizes: post first - rail second.

DESCRIPTION	PART NO.	PER SACK	WEIGHT EA.	NOTES
1-3/8" x 1-3/8"	015546	50	.60	
1-7/8" x 1-3/8"	015551	50	.68	
2-3/8" x 1-3/8"	015552	50	.88	
Use 5/16" x 2" Carriage Bolt – Pt. #010715				
2-3/8" x 1-5/8"	015555	50	.88	
2-7/8" x 1-5/8"	015556	50	.96	
Use 5/16" x 2-1/2" Carriage Bolt – Pt. # 010718				

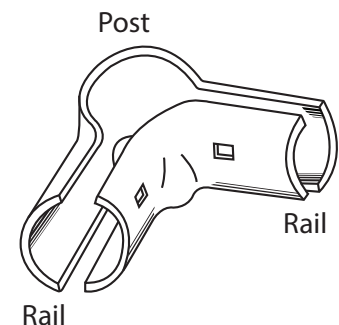

Heavy Corner Rail Clamps / Pressed Steel – Galvanized

3/16" Wall Thickness • Sizes: post first - rail second.

DESCRIPTION	PART NO.	PER SACK	WEIGHT EA.	NOTES
4" x 1-5/8"	645H00	50	3.00	

Use 5/16" x 2-1/2" Carriage Bolt – Pt. # 010718

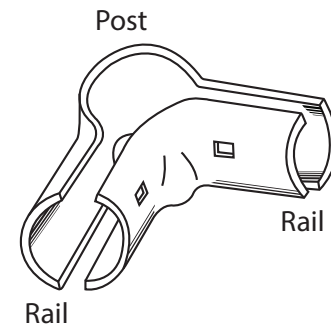

Sleeves / Galvanized – Steel

DESCRIPTION	PART NO.	PER SACK	WEIGHT EA.	NOTES
1-3/8" x 6"	012601	100	.39	
1-5/8" x 6"	012602	50	.53	
1-5/8" x 7"	012603	50	.61	
1-7/8" x 6"	012604	50	.57	

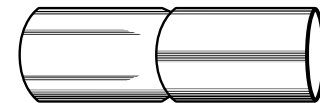

Sleeves - Expansion Type / With Spring • Galvanized – Steel

DESCRIPTION	PART NO.	PER SACK	WEIGHT EA.	NOTES
1-5/8" x 7"	012701	25	.74	
Expansion Spring Only	012705	25	.15	



Truss Tighteners / Pressed Steel – Galvanized

DESCRIPTION	PART NO.	PER SACK	WEIGHT EA.	NOTES
Residential	018150	100	.24	
Industrial	018101	100	.45	

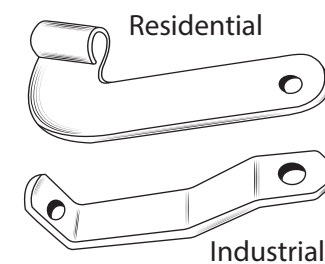

Threaded Truss Rods / 3/8" Diameter with Nut • Galvanized – Steel

DESCRIPTION	PART NO.	PER SACK	WEIGHT EA.	NOTES
10' 6"	017901	25	3.95	
11'	017902	25	4.13	
12'	017903	25	4.51	
20'	017950	25	7.52	

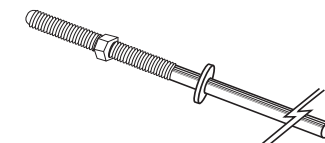

Tension Bars 3/16" x 5/8" / Galvanized - Steel

DESCRIPTION	PART NO.	PER SACK	WEIGHT EA.	NOTES
34"	013601	25	1.13	
40"	013602	25	1.33	
46"	013603	25	1.53	
58"	013604	25	1.92	
70"	013605	25	2.32	

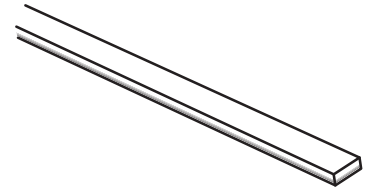

Tension Bars 3/16" x 3/4" / Galvanized - Steel

DESCRIPTION	PART NO.	PER SACK	WEIGHT EA.	NOTES
34"	013701	25	1.35	
40"	013702	25	1.59	
46"	013703	25	1.83	
58"	013704	25	2.31	
70"	013705	25	2.79	
82"	013706	25	3.27	
94"	013707	25	3.74	
118"	013709	25	4.70	
142"	013710	25	5.66	

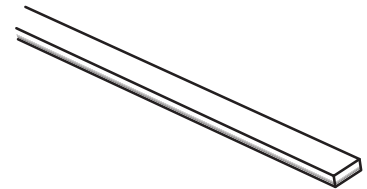

Tension Bars 1/4" x 3/4" / Galvanized - Steel

DESCRIPTION	PART NO.	PER SACK	WEIGHT EA.	NOTES
58"	013745	25	3.08	
70"	013747	25	3.72	
82"	013749	25	4.36	
94"	013751	25	5.00	
118"	013755	25	6.27	
142"	013759	25	7.55	

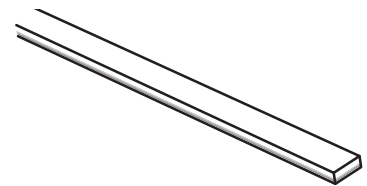

Mini Mesh Tension Bars 3/16" x 3/8" / Galvanized - Steel

DESCRIPTION	PART NO.	PER SACK	WEIGHT EA.	NOTES
47"	013730	25	1.20	
59"	013731	25	1.60	
71"	013732	25	1.44	
83"	013733	25	1.68	
95"	013734	25	1.95	
119"	013735	25	2.39	
143"	013736	25	2.88	

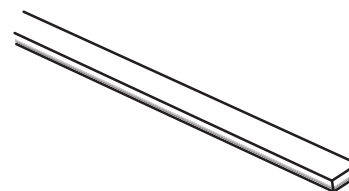

Mini Mesh Tension Bars 3/16" x 1/2" / Galvanized - Steel

DESCRIPTION	PART NO.	PER SACK	WEIGHT EA.	NOTES
48"	013719	25	1.35	
60"	013720	25	1.59	
72"	013721	25	1.83	
84"	013722	25	2.31	
96"	013723	25	2.79	
120"	013724	25	3.27	
144"	013718	25	3.74	

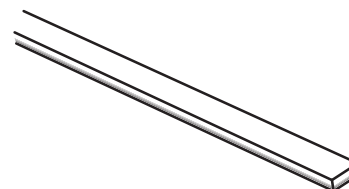

Regular Tension Bands - Domestic / 14 ga. x 3/4" Pressed Steel - Galvanized

DESCRIPTION	PART NO.	PER SACK	WEIGHT EA.	NOTES
1-3/8"	10101D	250	.12	
1-5/8"	10102D	250	.14	
1-7/8"	10103D	250	.15	
2-3/8"	10104D	250	.18	
2-7/8"	10105D	100	.20	
4"	10108D	100	.24	

Use 5/16" x 1-1/4" Carriage Bolt - Pt. #010701 or Pt. #10701D (Domestic)

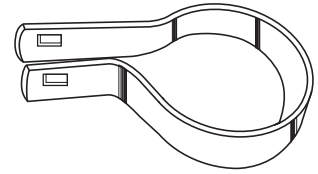

Beveled Tension Bands - Domestic / 12 ga. x 7/8" Pressed Steel - Galvanized

DESCRIPTION	PART NO.	PER SACK	WEIGHT EA.	NOTES
1-5/8"	10252D	250	.21	
1-7/8"	10253D	250	.22	
2-3/8"	10254D	250	.26	
2-7/8"	10255D	100	.34	
4"	10258D	100	.38	
6-5/8"	10260D	50	.56	

Use 5/16" x 1-1/4" Carriage Bolt - Pt. #010701 or Pt. #10701D (Domestic)

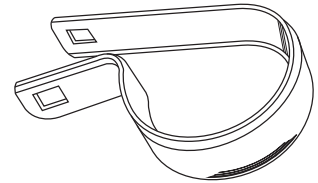

Heavy Tension Bands - Domestic / 1/8" x 1" Pressed Steel - Galvanized

DESCRIPTION	PART NO.	PER SACK	WEIGHT EA.	NOTES
1-5/8"	10202D	250	.30	
1-7/8"	10203D	100	.33	
2-3/8"	10204D	100	.39	
2-7/8"	10205D	100	.42	
3-1/2"	10207D	100	.50	
4"	10208D	50	.59	
4-1/2"	000V05	50	.66	
6-5/8"	10210D	50	.85	

Use 3/8" x 1-1/2" Carriage Bolt - Pt. #010704

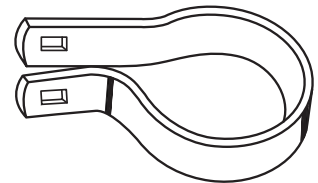

Regular Brace Bands - Domestic / 12 ga. x 3/4" Pressed Steel - Galvanized

DESCRIPTION	PART NO.	PER SACK	WEIGHT EA.	NOTES
1-5/8"	10302D	250	.15	
1-7/8"	10303D	250	.18	
2-3/8"	10304D	250	.21	
2-7/8"	10305D	100	.24	
4"	10308D	100	.34	

Use 5/16" x 1-1/4" Carriage Bolt - Pt. #010701 or Pt. #10701D (Domestic)

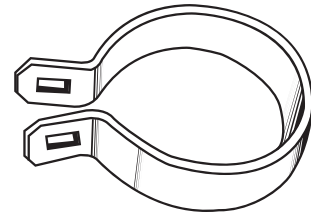

Beveled Brace Bands - Domestic / 12 ga. x 7/8" Pressed Steel - Galvanized

DESCRIPTION	PART NO.	PER SACK	WEIGHT EA.	NOTES
1-5/8"	10452D	300	.20	
1-7/8"	10453D	250	.22	
2-3/8"	10454D	250	.25	
2-7/8"	10455D	100	.33	
4"	10458D	100	.41	
6-5/8"	10460D	50	.76	

Use 5/16" x 1-1/4" Carriage Bolt - Pt. #010701 or Pt. #10701D (Domestic)

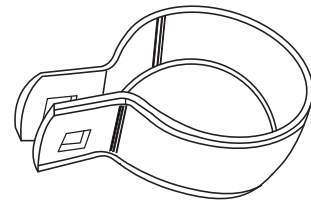

Heavy Brace Bands - Domestic / 1/8" x 1" Pressed Steel - Galvanized

DESCRIPTION	PART NO.	PER SACK	WEIGHT EA.	NOTES
1-5/8"	10402D	250	.25	
1-7/8"	10403D	100	.26	
2-3/8"	10404D	100	.32	
2-7/8"	10405D	100	.36	
3-1/2"	10407D	100	.44	
4"	10408D	50	.49	
4-1/2"	10409D	50	.55	
6-5/8"	10410D	50	.77	
8-5/8"	10411D	50	1.02	

Use 3/8" x 1-1/2" Carriage Bolt - Pt. #010704

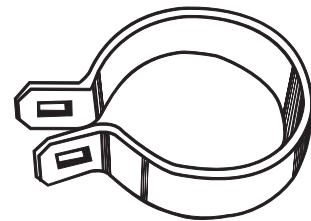

Caps - Domestic / Pressed Steel - Galvanized

DESCRIPTION	PART NO.	PER SACK	WEIGHT EA.	NOTES
1-5/8"	11602D	250	.16	
1-7/8"	11603D	200	.16	
2-3/8"	11604D	125	.34	
2-7/8"	11605D	100	.53	
3-1/2"	11607D	25	.88	
4"	11608D	25	1.00	
4-1/2"	11609D	25	.89	
6-5/8"	11610D	10	3.50	
8-5/8"	005439	10	1.40	

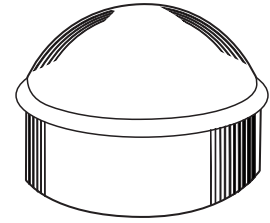

Eye Tops - Standard - Domestic / Pressed Steel - Galvanized

DESCRIPTION	PART NO.	PER SACK	WEIGHT EA.	NOTES
1-5/8" x 1-5/8"	12252D	100	.51	
1-7/8" x 1-5/8"	12253D	100	.53	
2-3/8" x 1-5/8"	12254D	50	.64	
2-7/8" x 1-5/8"	12255D	50	1.02	

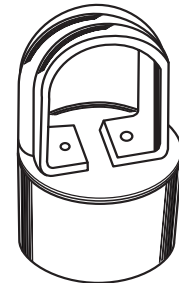

Barb Wire Arms Upright - Domestic / Pressed Steel - Galvanized

DESCRIPTION	PART NO.	PER SACK	WEIGHT EA.	NOTES
1-5/8" x 1-5/8"	012891	25	1.40	
1-7/8" x 1-5/8"	012892	25	1.50	
2-3/8" x 1-5/8"	012893	25	1.60	



Barb Wire Arms 45° - Domestic / One-Piece Line Arm • Pressed Steel - Galvanized

DESCRIPTION	PART NO.	PER SACK	WEIGHT EA.	NOTES
1-7/8" x 1-5/8"	013105	25	1.82	
2-3/8" x 1-5/8"	13109D	25	1.71	
2-7/8" x 1-5/8"	13129D	25	2.25	
3-1/2" x 1-5/8"	03983D	25	2.45	

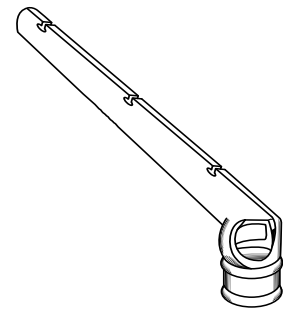

Barb Arms Breakaway 45° - Domestic / One-Piece Line Arm 3-Strand Pressed Steel – Galvanized

DESCRIPTION	PART NO.	PER SACK	WEIGHT EA.	NOTES
2-7/8" x 1-5/8"	035999	40	2.25	

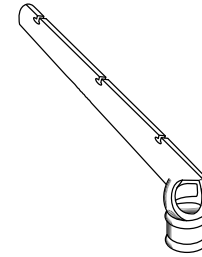

Texas Barb Wire Arms - Domestic / Pressed Steel – Galvanized

DESCRIPTION	PART NO.	PER SACK	WEIGHT EA.	NOTES
1-5/8" x 1-3/8"	013131	50	1.60	
1-7/8" x 1-5/8"	013135	50	1.70	
2-3/8" x 1-5/8"	013136	50	2.00	
2-7/8" x 1-5/8"	013144	50	2.10	

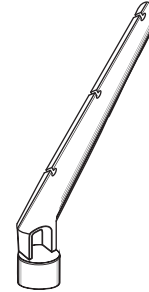

Barb Wire V-Arms - Domestic / One-Piece Line Arm 6-Strand Pressed Steel – Galvanized

DESCRIPTION	PART NO.	PER SACK	WEIGHT EA.	NOTES
1-7/8" x 1-5/8"	13121D	15	2.17	
2-3/8" x 1-5/8"	13122D	15	2.28	
2-3/8" x 1-5/8"	080089	15	2.75	
2-7/8" x 1-5/8"	13126D	15	3.00	

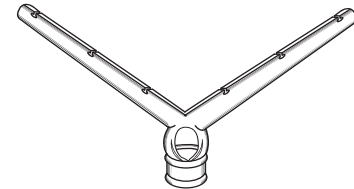

Corner Arms 45° - Domestic / Pressed Steel – Galvanized

DESCRIPTION	PART NO.	PER SACK	WEIGHT EA.	NOTES
2-3/8"	13380D	5	3.20	
2-7/8"	13381D	5	3.50	
3-1/2"	13383D	5	5.25	
4"	005662	5	5.50	

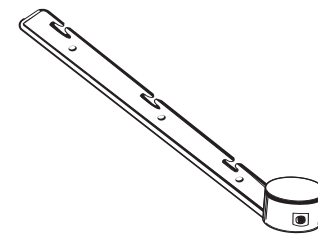

Corner V-Arms - Domestic / 6-Strand • Pressed Steel – Galvanized

DESCRIPTION	PART NO.	PER SACK	WEIGHT EA.	NOTES
2-3/8"	13390D	5	6.00	
2-7/8"	13391D	5	6.30	
3-1/2"	36318D	5	6.68	
4"	13392D	5	10.60	

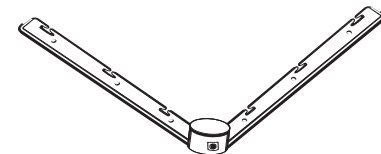

Galvanized Steel Ties - Domestic / Class 3 • 11 gauge

DESCRIPTION	PART NO.	PER CASE	CASE WEIGHT	NOTES
(1-7/8") 7-1/2"	009225	2000	41.98	

NOTE: Sold only in full bags of 100 pieces.

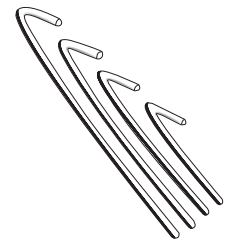

Rail End - Domestic / Die-Cast Aluminum

DESCRIPTION	PART NO.	PER SACK	WEIGHT EA.	NOTES
1-5/8"	12302D	250	.16	

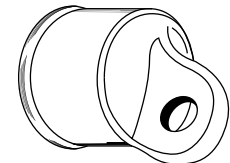

Rail Ends - Domestic / Pressed Steel - Galvanized

DESCRIPTION	PART NO.	PER SACK	WEIGHT EA.	NOTES
1-5/8"	12506D	100	.33	
1-7/8"	12508D	50	.39	
2-3/8"	12510D	50	.49	

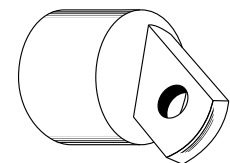

Rail Ends 2-Hole - Domestic / Pressed Steel - Galvanized

DESCRIPTION	PART NO.	PER SACK	WEIGHT EA.	NOTES
1-5/8"	12507D	100	.48	
1-7/8"	12509D	50	.51	

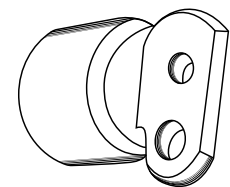

Combo Rail Ends - Domestic / Pressed Steel - Galvanized

DESCRIPTION	PART NO.	PER SACK	WEIGHT EA.	NOTES
1-5/8"	12511D	100	.35	
1-7/8"	318Y00	100	.40	

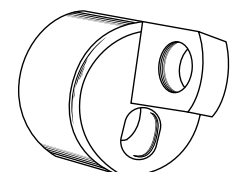

Brace Or End Rail Clamps - Domestic / Pressed Steel - Galvanized

Sizes: post first - rail second.

DESCRIPTION	PART NO.	PER SACK	WEIGHT EA.	NOTES
1-5/8" x 1-5/8"	15503D	100	.50	
2-7/8" x 1-5/8"	15508D	50	.65	

Use 5/16" x 2-1/4" Carriage Bolt - Pt. #010716

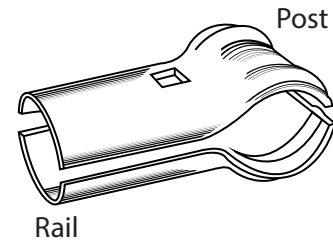

Line Rail Clamps - Domestic / Pressed Steel - Galvanized

Sizes: post first - rail second

DESCRIPTION	PART NO.	PER SACK	WEIGHT EA.	NOTES
1-7/8" x 1-5/8"	15535D	50	.73	
2-3/8" x 1-5/8"	15536D	50	.80	
2-7/8" x 1-5/8"	15538D	50	1.00	
4" x 1-5/8"	15540D	50	1.06	

Use 5/16" x 2-1/2" Carriage Bolt - Pt. #010718

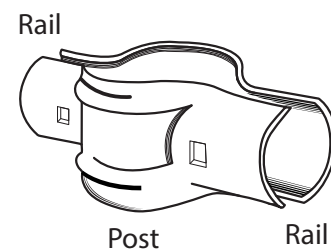

Corner Rail Clamp - Domestic / Pressed Steel - Galvanized

Sizes: post first - rail second

DESCRIPTION	PART NO.	PER SACK	WEIGHT EA.	NOTES
2-7/8" x 1-5/8"	15556D	50	.96	
2-7/8" x 2-3/8"	N00086	—	.88	

Use 5/16" x 2-1/2" Carriage Bolt - Pt. # 010718

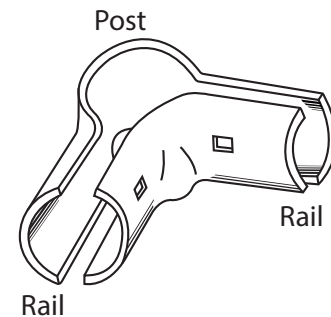

Sleeves - Domestic / Galvanized - Steel

DESCRIPTION	PART NO.	PER SACK	WEIGHT EA.	NOTES
1-3/8" x 6"	12601D	100	.39	
1-5/8" x 6"	12602D	50	.53	
1-7/8" x 6"	12604D	50	.57	
1-7/8" x 6"	N00631	—	.67	



Truss Tightener - Domestic / Pressed Steel - Galvanized

DESCRIPTION	PART NO.	PER SACK	WEIGHT EA.	NOTES
Industrial	18101D	100	.45	

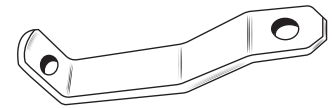

Threaded Truss Rods - Domestic / 3/8" Diameter with Nut • Galvanized - Steel

DESCRIPTION	PART NO.	PER SACK	WEIGHT EA.	NOTES
11'	17902D	25	4.13	
12'	17903D	25	4.51	
20'	17950D	25	7.52	

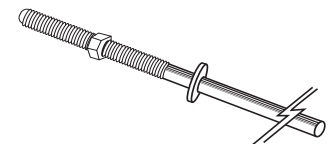

Tension Bars 3/16" x 5/8" - Domestic / Galvanized - Steel

DESCRIPTION	PART NO.	PER SACK	WEIGHT EA.	NOTES
46"	13603D	25	1.53	
58"	13604D	25	1.92	

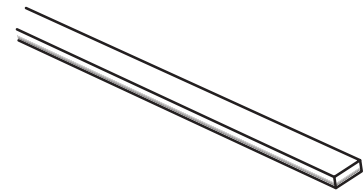

Tension Bars 3/16" x 3/4" - Domestic / Galvanized - Steel

DESCRIPTION	PART NO.	PER SACK	WEIGHT EA.	NOTES
58"	13704D	25	2.31	
70"	13705D	25	2.79	
82"	13706D	25	3.27	
94"	13707D	25	3.74	
118"	13709D	25	4.70	
143"	452Y00	25	5.66	

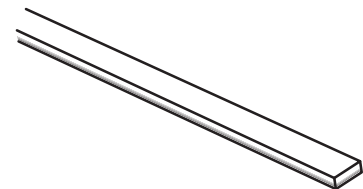

Tension Bars 1/4" x 3/4" - Domestic / Galvanized - Steel

DESCRIPTION	PART NO.	PER SACK	WEIGHT EA.	NOTES
70"	13747D	25	3.72	
82"	13749D	25	4.36	
94"	13751D	25	5.00	

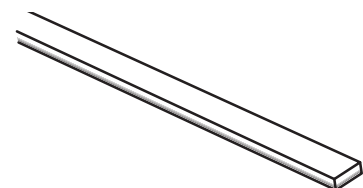

Regular Tension Bands / 14 ga. x 3/4" Pressed Steel - Galvanized • Polyester

DESCRIPTION	PART NO.	QTY. BOX	WEIGHT	NOTES
1-3/8"	60001_	50	.12	
1-5/8"	60002_	50	.14	
1-7/8"	60003_	50	.16	
2-3/8"	60004_	50	.18	
2-7/8"	60005_	50	.22	
4"	60008_	50	.29	

Use 5/16" x 1-1/4" Carriage Bolt - Pt. #010701 or Pt. #62201_ (Spectra)

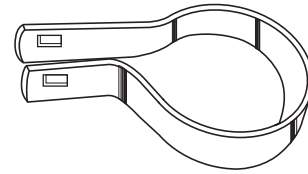

Beveled Tension Bands / 12 ga. x 7/8" Pressed Steel - Galvanized • Polyester

DESCRIPTION	PART NO.	QTY. BOX	WEIGHT	NOTES
1 - 7/8"	60011_	50	.26	
2 - 3/8"	60012_	50	.28	
2 - 7/8"	60013_	50	.31	
4"	60014_	50	.42	
6 - 5/8"	60019_	25	.64	

Use 5/16" x 1-1/4" Carriage Bolt - Pt. #010701 or Pt. #62201_ (Spectra)

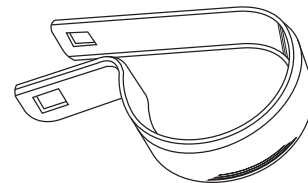

Heavy Tension Bands / 1/8" x 1" Pressed Steel - Galvanized • Polyester

DESCRIPTION	PART NO.	QTY. BOX	WEIGHT	NOTES
2 - 7/8"	60035_	50	.44	
4"	60038_	50	.59	
6 - 5/8"	60010_	50	.85	

Use 3/8" x 1 - 1/2" Carriage Bolt - Part # 010704

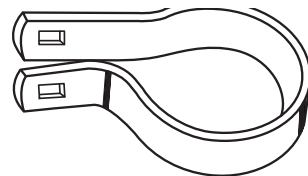

Snappy Tension Band / With Aluminum Fastener • Polyester

DESCRIPTION	PART NO.	QTY. BOX	WEIGHT EA.	NOTES
1-3/8"	60061_	100	.14	

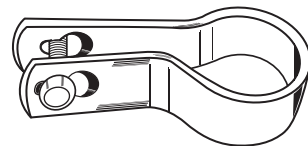

Add the following number to the part no. for desired color:

1-Forest Green 2-Midnight Black 3-Sierra Brown

Regular Brace Bands / 12 ga. x 3/4" Pressed Steel – Galvanized • Polyester

DESCRIPTION	PART NO.	QTY. BOX	WEIGHT EA.	NOTES
1-5/8"	60082_	50	.15	
1-7/8"	60083_	50	.18	
2-3/8"	60084_	50	.21	
2-7/8"	60085_	50	.26	
4"	60088_	50	.34	

Use 5/16" x 1-1/4" Carriage Bolt – Pt. #010701 or Pt. #62201_ (Spectra)

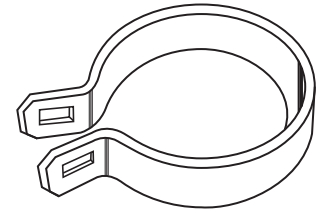

Beveled Brace Bands / 12 ga. x 7/8" Pressed Steel – Galvanized • Polyester

DESCRIPTION	PART NO.	QTY. BOX	WEIGHT EA.	NOTES
2-3/8"	60015_	50	.27	
2-7/8"	60016_	50	.33	
4"	60017_	50	.41	
6-5/8"	60024_	25	.76	

Use 5/16" x 1-1/4" Carriage Bolt – Pt. #010701 or Pt. #62201_ (Spectra)

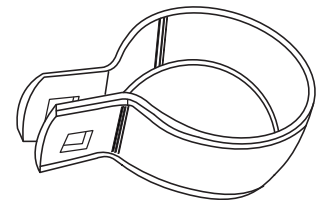

Heavy Brace Bands / 1/8" x 1" Pressed Steel - Galvanized • Polyester

DESCRIPTION	PART NO.	QTY. BOX	WEIGHT EA.	NOTES
2-3/8"	60086_	50	.29	
2-7/8"	60145_	50	.35	
4"	60148_	50	.51	
6-5/8"	60090_	50	.80	
8-5/8" - Black	952S00	50	1.05	

Use 3/8" x 1 - 1/2" Carriage Bolt - Part # 010704

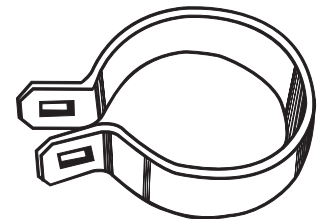

Add the following number to the part no. for desired color:

1-Forest Green 2-Midnight Black 3-Sierra Brown

Caps, Heavy / Die-Cast Aluminum • Polyester

DESCRIPTION	PART NO.	PER SACK	WEIGHT EA.	NOTES
1-3/8"	60191_	100	.06	
1-5/8"	60192_	100	.09	
1-7/8"	60193_	100	.10	
2-3/8"	60194_	100	.14	
2-7/8"	60303_	100	.30	

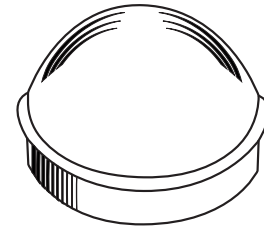

Caps / Pressed Steel – Galvanized • Polyester

DESCRIPTION	PART NO.	QTY. BOX	WEIGHT EA.	NOTES
1-5/8"	60237_	25	.16	
1-7/8"	60238_	25	.27	
2-3/8"	60239_	25	.34	
2-7/8"	60240_	25	.53	
4"	60241_	25	1.00	
6-5/8"	63426_	25	1.40	

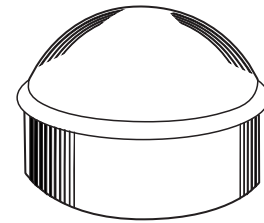

Eye Tops / Die-Cast Aluminum • Polyester

DESCRIPTION	PART NO.	QTY. BOX	WEIGHT EA.	NOTES
1-5/8" x 1-3/8"	60301_	50	.22	
1-7/8" x 1-3/8"	60302_	50	.26	

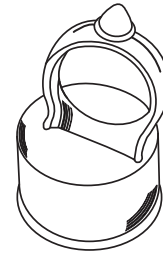

Eye Tops - Standard / Pressed Steel – Galvanized • Polyester

DESCRIPTION	PART NO.	QTY. BOX	WEIGHT EA.	NOTES
1-7/8" x 1-5/8"	60392_	25	.54	
2-3/8" x 1-5/8"	60393_	25	.61	
2-7/8" x 1-5/8"	60394_	25	1.08	
4" x 1-5/8"	60395_	25	4.96	

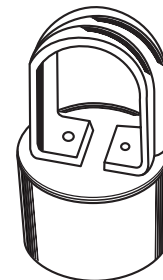

Add the following number to the part no. for desired color:
1-Forest Green 2-Midnight Black 3-Sierra Brown

Barb Wire Arms 45° / One-Piece Line Arm Pressed Steel – Galvanized • Polyester

DESCRIPTION	PART NO.	QTY./PKG.	WEIGHT EA.	NOTES
1-5/8" x 1-5/8"	60531_	25	1.61	
1-7/8" x 1-5/8"	60532_	25	2.25	
2-3/8" x 1-5/8"	60533_	25	2.50	

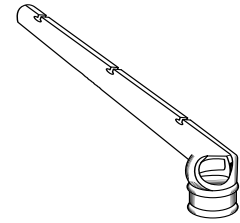

Barb Wire V-Arms 45° / Pressed Steel – Galvanized • Polyester

DESCRIPTION	PART NO.	QTY./PKG.	WEIGHT EA.	NOTES
1-7/8" x 1-5/8"	60537_	5	2.93	
2-3/8" x 1-5/8"	60538_	5	3.20	

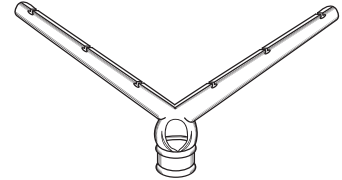

Corner Arms 45° / Pressed Steel – Galvanized • Polyester

DESCRIPTION	PART NO.	PER SACK	WEIGHT EA.	NOTES
2-3/8"	60591_	5	3.20	
2-7/8"	60592_	5	3.50	

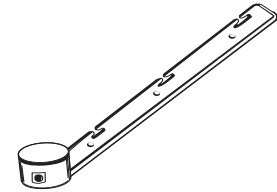

Aluminum Ties - Spectra / 11-1/2 Gauge Core / 9 Gauge Finish

DESCRIPTION	PART NO.	PER CASE	CASE WEIGHT	NOTES
(1-5/8") 6-1/2"	62572_	2400	24.95	
(2-3/8") 8-1/4"	62573_	1700	22.85	
(2-7/8") 10-1/2"	62576_	1000	19.75	

NOTE: Sold only in full bags of 100 pieces.

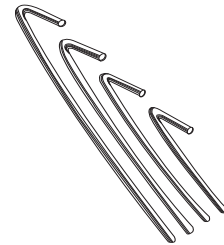

Aluminum Ties - Spectra / 9 Gauge Core / 6 Gauge Finish

DESCRIPTION	PART NO.	PER CASE	CASE WEIGHT	NOTES
(1-5/8") 6-1/2"	62577_	1000	22.10	
(2-3/8") 8-1/4"	62574_	1000	23.88	
(4") 12" - Black	002361	1000	31.25	

NOTE: Sold only in full bags of 100 pieces.

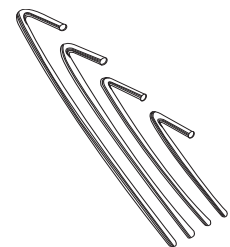

Add the following number to the part no. for desired color:
1-Forest Green 2-Midnight Black 3-Sierra Brown

Rail Ends / Die Cast Aluminum • Polyester

DESCRIPTION	PART NO.	QTY. BOX	WEIGHT EA.	NOTES
1-3/8"	60631_	50	.13	
1-5/8"	60632_	50	.16	

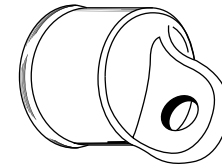

Rail End / Pressed Steel - Galvanized • Polyester

DESCRIPTION	PART NO.	QTY. BOX	WEIGHT EA.	NOTES
1-5/8"	60691_	50	.39	

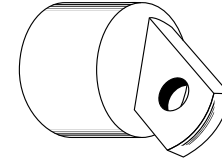

Combo Rail End / Pressed Steel - Galvanized • Polyester

DESCRIPTION	PART NO.	QTY. BOX	WEIGHT EA.	NOTES
1-5/8"	60018_	50	.39	

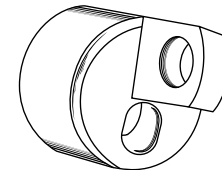

Brace Or End Rail Clamps / Pressed Steel – Galvanized • Polyester

Sizes: post first - rail second.

DESCRIPTION	PART NO.	QTY. BOX	WEIGHT EA.	NOTES
1-3/8" x 1-3/8"	61481_	50	.30	
Use 5/16" x 2" Carriage Bolt – Pt. #010715				
1-5/8" x 1-5/8"	61484_	50	.43	
Use 5/16" x 2-1/2" Carriage Bolt – Pt. #010718				

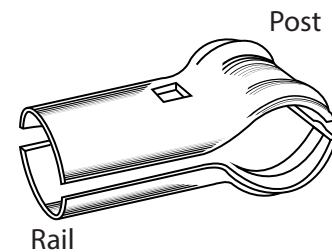

Line Rail Clamps / Pressed Steel – Galvanized • Polyester

Sizes: post first - rail second.

DESCRIPTION	PART NO.	QTY. BOX	WEIGHT EA.	NOTES
1-7/8" x 1-3/8"	60028_	25	.75	
Use 5/16" x 2" Carriage Bolt – Pt. #010715				
1-7/8" x 1-5/8"	60026_	50	.75	
2-3/8" x 1-5/8"	61490_	50	.80	
2-7/8" x 1-5/8"	60027_	50	1.00	
Use 5/16" x 2-1/2" Carriage Bolt – Pt. #010718				

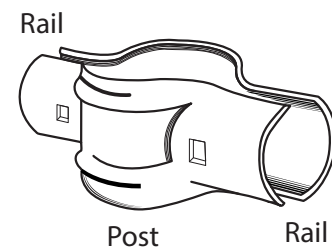

Sleeves / Steel - Galvanized • Polyester

DESCRIPTION	PART NO.	PER SACK	WEIGHT EA.	NOTES
1-3/8" x 6"	60711_	60	.38	
1-5/8" x 7"	60712_	25	.57	

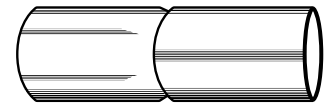

Truss Tightener / Pressed Steel – Galvanized • Polyester

DESCRIPTION	PART NO.	QTY./PKG.	WEIGHT EA.	NOTES
Industrial	60761_	25	.45	

Also used for Gate Truss Tightener

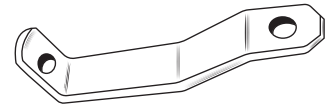

Threaded Truss Rod / 3/8" Diameter with Nut • Steel – Galvanized • Polyester

DESCRIPTION	PART NO.	PER SACK	WEIGHT EA.	NOTES
12'	60778_	25	3.50	

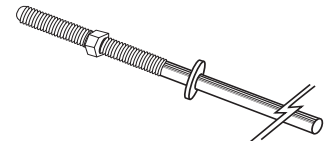

Add the following number to the part no. for desired color:
1-Forest Green 2-Midnight Black 3-Sierra Brown

Tension Bars 3/16" x 5/8" / Fiberglass • Polyester

DESCRIPTION	PART NO.	QTY. BOX	WEIGHT EA.	NOTES
34"	60830_	25	.30	
40"	60831_	25	.35	
46"	60832_	25	.40	
58"	60833_	25	.50	
70"	60834_	25	.60	

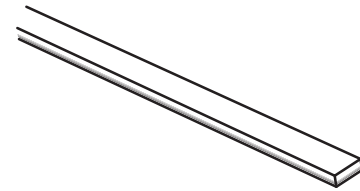

Tension Bars 1/4" x 3/4" / Fiberglass • Polyester

DESCRIPTION	PART NO.	QTY. BOX	WEIGHT EA.	NOTES
34"	60795_	25	.36	
40"	60796_	25	.43	
46"	60797_	25	.49	
58"	60798_	25	.62	
70"	60799_	25	.75	
118"	60824_	25	1.25	

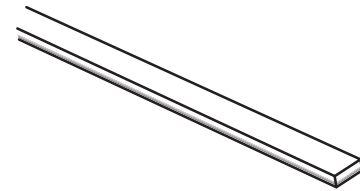

Tension Bars 3/16" x 5/8" / Steel • Polyester

DESCRIPTION	PART NO.	QTY. BOX	WEIGHT EA.	NOTES
34"	60810_	25	1.53	
40"	60840_	25	1.53	
46"	60829_	25	1.53	
58"	60933_	25	1.92	

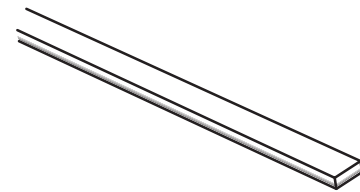

Tension Bars 3/16" x 3/4" / Steel • Polyester

DESCRIPTION	PART NO.	QTY. BOX	WEIGHT EA.	NOTES
70"	60934_	25	2.10	
82"	60935_	25	2.46	
94"	60821_	25	2.82	
118"	60822_	25	3.54	
142"	60823_	25	4.26	

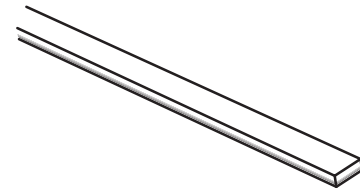

Add the following number to the part no. for desired color:
1-Forest Green 2-Midnight Black 3-Sierra Brown

Regular Tension Bands / 14 ga. x 3/4" Pressed Steel – Galvanized • Heavy Mil

DESCRIPTION	PART NO.	QTY./PKG.	WEIGHT EA.	NOTES
1-3/8"	48001_	50	.15	
1-5/8"	48002_	50	.14	
1-7/8"	48003_	50	.16	
2-3/8"	48004_	50	.18	
2-7/8"	48005_	50	.22	
4"	48006_	50	.29	

Use 5/16" x 1-1/4" Carriage Bolt – Pt. #010701 or Pt. #62201_ (Spectra)

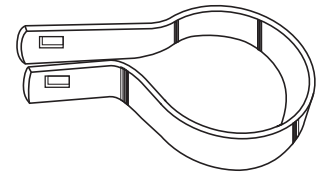

Beveled Tension Bands / 12 ga. x 7/8" Pressed Steel – Galvanized • Heavy Mil

DESCRIPTION	PART NO.	QTY./PKG.	WEIGHT EA.	NOTES
1-5/8"	48011_	50	.23	
1-7/8"	48012_	50	.26	
2-3/8"	48013_	50	.28	
2-7/8"	48014_	50	.31	
4"	48015_	50	.42	
6-5/8"	48016_	50	.64	

Use 5/16" x 1-1/4" Carriage Bolt – Pt. #010701 or Pt. #62201_ (Spectra)

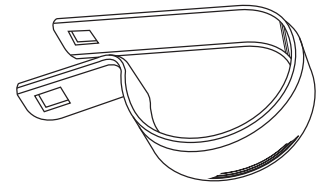

Heavy Tension Bands / 1/8" x 1" Pressed Steel – Galvanized • Heavy Mil

DESCRIPTION	PART NO.	QTY./PKG.	WEIGHT EA.	NOTES
1-5/8"	48007_	50	.36	
1-7/8"	48008_	50	.39	
2-3/8"	48017_	50	.40	
2-7/8"	48018_	50	.45	
4"	48019_	50	.59	
6-5/8"	48009_	50	1.02	
8-5/8"	48010_	100	1.32	

Use 3/8" x 1-1/2" Carriage Bolt – Pt. #010704

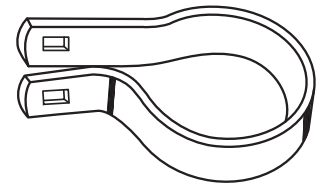

Regular Brace Bands / 12 ga. x 3/4" Pressed Steel – Galvanized • Heavy Mil

DESCRIPTION	PART NO.	QTY./PKG.	WEIGHT EA.	NOTES
1-5/8"	48020_	50	.15	
1-7/8"	48028_	50	.18	
2-3/8"	48029_	50	.21	
2-7/8"	48033_	50	.26	
4"	48034_	50	.34	

Use 5/16" x 1-1/4" Carriage Bolt – Pt. #010701 or Pt. #62201_ (Spectra)

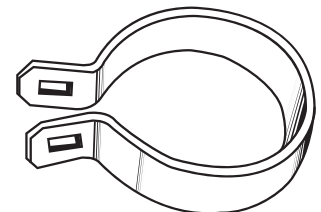

Add the following number to the part no. for desired color:
1-Forest Green 2-Midnight Black 3-Sierra Brown

Beveled Brace Bands / 12 ga. x 7/8" Pressed Steel – Galvanized • Heavy Mil

DESCRIPTION	PART NO.	QTY./PKG.	WEIGHT EA.	NOTES
1-5/8"	48110_	50	.20	
1-7/8"	48112_	50	.22	
2-3/8"	48114_	50	.27	
2-7/8"	48115_	50	.33	
4"	48116_	50	.41	
6-5/8"	48117_	25	.76	

Use 5/16" x 1-1/4" Carriage Bolt – Pt. #010701 or Pt. #62201_ (Spectra)

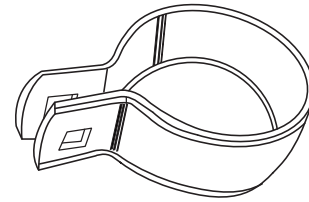

Heavy Brace Bands / 1/8" x 1" Pressed Steel – Galvanized • Heavy Mil

DESCRIPTION	PART NO.	QTY./PKG.	WEIGHT EA.	NOTES
1-5/8"	48024_	50	.30	
1-7/8"	48025_	50	.31	
2-3/8"	48021_	50	.34	
2-7/8"	48022_	50	.39	
4"	48023_	50	.50	
6-5/8"	48026_	50	.92	
8-5/8"	48027_	50	1.21	

Use 3/8" x 1-1/2" Carriage Bolt – Pt. #010704

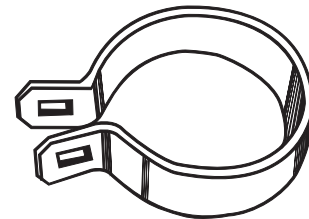

Caps, Heavy / Die-Cast Aluminum • Heavy Mil

DESCRIPTION	PART NO.	QTY./PKG.	WEIGHT EA.	NOTES
1-3/8"	48145_	50	.06	
1-5/8"	48146_	50	.09	
1-7/8"	48161_	50	.10	
2-3/8"	48163_	50	.14	
6-5/8"	48191_	4	.65	

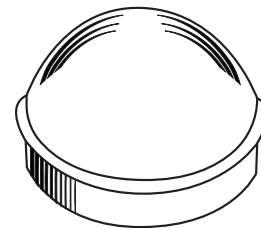

Caps / Pressed Steel – Galvanized • Heavy Mil

DESCRIPTION	PART NO.	PER SACK	WEIGHT EA.	NOTES
1-5/8"	48139_	25	.16	
1-7/8"	48140_	25	.27	
2-3/8"	48111_	25	.34	
2-7/8"	48113_	25	.53	
4"	48137_	25	1.00	

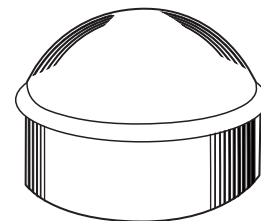

Add the following number to the part no. for desired color:
1-Forest Green 2-Midnight Black 3-Sierra Brown

Eye Tops / Die-Cast Aluminum • Heavy Mil

DESCRIPTION	PART NO.	QTY./PKG.	WEIGHT EA.	NOTES
1-5/8" x 1-3/8"	48196_	50	.22	
1-7/8" x 1-3/8"	48197_	50	.26	
1-7/8" x 1-5/8"	48319_	50	.30	
2-3/8" x 1-5/8"	48210_	50	.49	

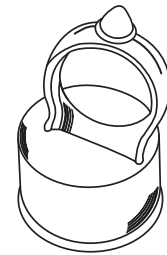

Eye Tops – Standard / Pressed Steel – Galvanized • Heavy Mil

DESCRIPTION	PART NO.	QTY./PKG.	WEIGHT EA.	NOTES
1-5/8" x 1-5/8"	48211_	25	.32	
1-7/8" x 1-5/8"	48124_	25	.54	
2-3/8" x 1-5/8"	48125_	25	.61	
2-7/8" x 1-5/8"	48126_	25	1.08	

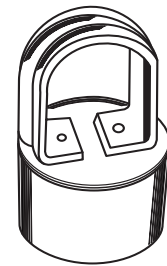

Barb Wire Arms 45° / One-Piece Line Arm • Pressed Steel – Galvanized • Heavy Mil

DESCRIPTION	PART NO.	PER SACK	WEIGHT EA.	NOTES
1-7/8" x 1-5/8"	48127_	25	1.68	
2-3/8" x 1-5/8"	48128_	25	1.76	
2-7/8" x 1-5/8"	48215_	25	1.68	

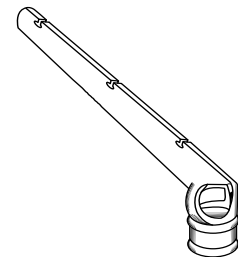

Corner Arm 45° / Pressed Steel – Galvanized • Heavy Mil

DESCRIPTION	PART NO.	PER SACK	WEIGHT EA.	NOTES
2-7/8"	48129_	5	3.50	

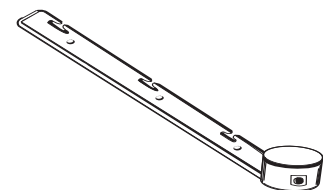

Add the following number to the part no. for desired color:
1-Forest Green 2-Midnight Black 3-Sierra Brown

Galvanized Steel Ties - Heavy Mil / 11 Gauge Finish

DESCRIPTION	PART NO.	PER CASE	CASE WEIGHT	NOTES
(1-3/8") 6"	62561_	2000	28.00	
(1-5/8") 6-1/2"	62562_	2000	30.00	
(1-5/8") 6-1/2" - Black	087141	2400	36.50	
(1-7/8") 7-1/2"	62563_	2000	34.00	
(2-3/8") 8-1/2"	62564_	2000	38.00	

NOTE: Sold only in full bags of 100 pieces.

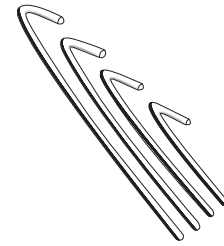

Galvanized Steel Ties - Heavy Mil / 9 Gauge Finish

DESCRIPTION	PART NO.	PER CASE	CASE WEIGHT	NOTES
(1-5/8") 6-1/2"	62568_	1000	19.00	
(1-7/8") 7-1/2"	62569_	1000	24.00	
(2-3/8") 8-1/2"	62570_	1000	29.00	

NOTE: Sold only in full bags of 100 pieces.

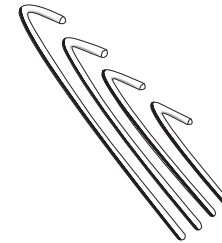

Rail End / Die-Cast Aluminum • Heavy Mil

DESCRIPTION	PART NO.	QTY./PKG.	WEIGHT EA.	NOTES
1-3/8"	48198_	50	.13	

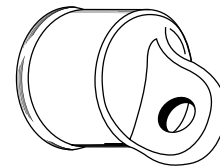

Rail Ends / Pressed Steel – Galvanized • Heavy Mil

DESCRIPTION	PART NO.	QTY./PKG.	WEIGHT EA.	NOTES
1-5/8"	48130_	50	.39	
1-7/8"	48132_	50	.45	

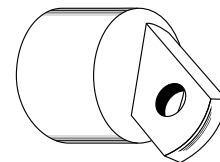

Rail End 2-Hole / Pressed Steel – Galvanized • Heavy Mil

DESCRIPTION	PART NO.	QTY./PKG.	WEIGHT EA.	NOTES
1-5/8"	48131_	25	.47	

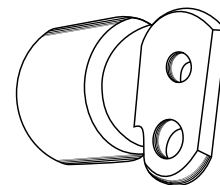

Combo Rail End / Pressed Steel - Galvanized • Heavy Mil

DESCRIPTION	PART NO.	QTY. BOX	WEIGHT EA.	NOTES
1-5/8"	48138_	25	.39	

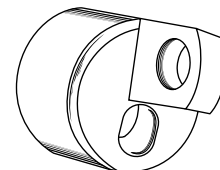

Brace Or End Rail Clamps / Pressed Steel - Galvanized - Heavy Mil

Sizes: post first - rail second.

DESCRIPTION	PART NO.	QTY. BOX	WEIGHT EA.	NOTES
1-3/8" x 1-3/8"	48188_	25	.33	

Use 5/16" x 2" Carriage Bolt - Pt. #010715

1-5/8" x 1-5/8"	48164_	25	.50	
1-7/8" x 1-5/8"	48165_	25	.54	
2-3/8" x 1-5/8"	48207_	25	.62	
2-7/8" x 1-5/8"	48219_	25	.76	

Use 5/16" x 2 1/4" Carriage Bolt - Pt. #010716

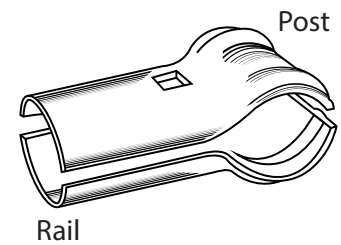

Line Rail Clamps / Pressed Steel - Galvanized - Heavy Mil

Sizes: post first - rail second.

DESCRIPTION	PART NO.	QTY./PKG.	WEIGHT EA.	NOTES
1-3/8" x 1-3/8"	48245_	25	.54	
1-5/8" x 1-3/8"	48206_	25	.54	
1-7/8" x 1-3/8"	48317_	25	.60	

Use 5/16" x 2" Carriage Bolt - Pt. #010715

1-5/8" x 1-5/8"	48166_	25	.60	
1-7/8" x 1-5/8"	48159_	25	.75	
2-3/8" x 1-5/8"	48162_	25	.80	
2-7/8" x 1-5/8"	48160_	25	1.00	
4" x 1-5/8"	48249_	25	1.00	

Use 5/16" x 2-1/2" Carriage Bolt - Pt. #010718

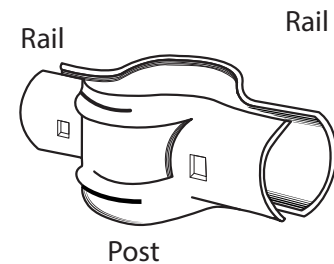

Add the following number to the part no. for desired color:
1-Forest Green 2-Midnight Black 3-Sierra Brown

Sleeves / Galvanized - Steel • Heavy Mil

DESCRIPTION	PART NO.	QTY./PKG.	WEIGHT EA.	NOTES
1-5/8" x 7"	48232_	25	.57	
1-7/8" x 6"	48276_	25	.60	

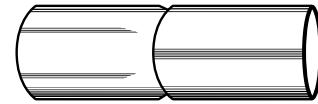

Sleeve - Expansion Type / With Spring • Galvanized - Steel • Heavy Mil

DESCRIPTION	PART NO.	QTY./PKG.	WEIGHT EA.	NOTES
1-5/8" x 7"	48233_	25	.87	

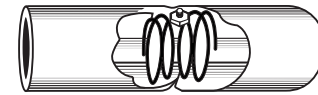

Truss Tightener / Pressed Steel - Galvanized • Heavy Mil

DESCRIPTION	PART NO.	QTY./PKG.	WEIGHT EA.	NOTES
Industrial	48234_	25	.59	

Also used for Gate Truss Tightener

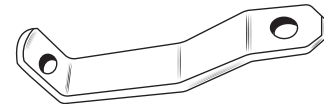

Threaded Truss Rod / 3/8" Diameter with Nut • Steel - Galvanized • Heavy Mil

DESCRIPTION	PART NO.	QTY./PKG.	WEIGHT EA.	NOTES
12'	48235_	25	4.51	

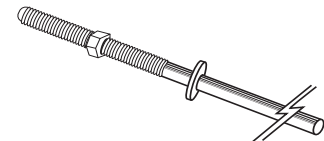

Add the following number to the part no. for desired color:
1-Forest Green 2-Midnight Black 3-Sierra Brown

Tension Bars 3/16" x 3/4" / Galvanized - Steel • Heavy Mil

DESCRIPTION	PART NO.	QTY. BOX	WEIGHT EA.	NOTES
34"	48236_	25	1.35	
40"	48237_	25	1.59	
46"	48238_	25	1.83	
58"	48239_	25	2.31	
70"	48240_	25	2.79	
82"	48242_	25	3.27	
94"	48244_	25	3.74	
118"	48246_	25	4.70	
142"	48247_	25	5.66	

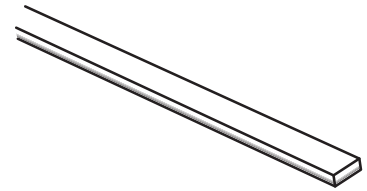

Add the following number to the part no. for desired color:
1-Forest Green 2-Midnight Black 3-Sierra Brown

Carriage Bolts / With Nut, Galvanized - Steel

DESCRIPTION	PART NO.	PER CASE	WEIGHT EA.	NOTES
1/4" x 3/4"	010720	1000	.022	
5/16" x 1-1/4"	010701	2000	.039	
5/16" x 1-1/2"	010702	1000	.045	
5/16" x 1-3/4"	010717	1000	.048	
5/16" x 2"	010715	1000	.051	
5/16" x 2-1/4"	010716	1000	.055	
5/16" x 2-1/2"	010718	1000	.059	
3/8" x 1-1/4"	010703	1000	.061	
3/8" x 1-1/2"	010704	1000	.066	
3/8" x 2"	010706	1000	.078	
3/8" x 2-1/4"	010707	1000	.084	
3/8" x 2-1/2"	010708	1000	.090	
3/8" x 3"	010710	1000	.101	
3/8" x 3-1/2"	010712	1000	.112	
3/8" x 4"	010719	1000	.124	

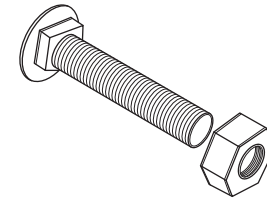

U Bolts / With Nut, Galvanized - Steel

DESCRIPTION	PART NO.	PER SACK	WEIGHT EA.	NOTES
1-7/8" OD x 1/2"	010751	50	.50	
2-7/8" OD x 1/2"	010753	50	.60	
4" OD x 1/2"	010755	50	.67	
4-1/2" OD x 1/2"	010756	50	.83	
6-5/8" OD x 5/8"	010757	50	1.84	

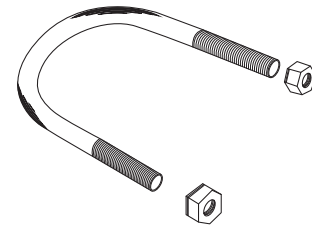

Note: Not for cantilever gate rollers.

Hex Nuts / Galvanized - Steel

DESCRIPTION	PART NO.	PER SACK	WEIGHT EA.	NOTES
1/4"	010791	100	.007	
5/16"	010792	100	.011	
3/8"	010793	100	.016	
1/2"	010795	100	.035	

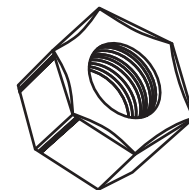

Flat Washer / Zinc-Plated Steel

DESCRIPTION	PART NO.	QTY PER PKG.	PKG. WT.	NOTES
3/8" bolt size	010779	67	1.00	

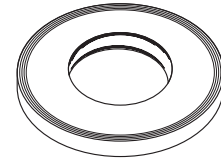

Round Head Rivet / Galvanized - Steel

DESCRIPTION	PART NO.	PER SACK	WEIGHT EA.	NOTES
5/16" x 2-1/4"	010774	100	.058	

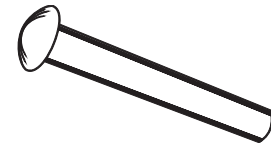

Tek Screws / Self-Drilling, Self-Tapping, Zinc-Plated Steel

DESCRIPTION	PART NO.	PER SACK	WEIGHT EA.	NOTES
No. 12 x 3/4"	023660	100	.010	
No. 14 x 3/4"	023667	1000	.009	
No. 14 x 1-1/4"	332X00	1000	.050	

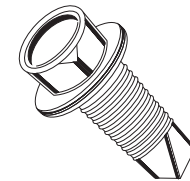

Eye Bolts / With Nut, Galvanized - Steel

DESCRIPTION	PART NO.	PER SACK	WEIGHT EA.	NOTES
3/8" x 6" with 5/8" eye	010731	100	.25	
5/16" x 4" with 5/8" eye	010740	100	.01	
1/4" x 5" with 5/8" eye	010749	100	.50	

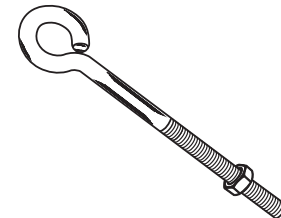

Barb Wire Hook Bolt / With Nut, Galvanized - Steel

DESCRIPTION	PART NO.	PER SACK	WEIGHT EA.	NOTES
1/4" x 6"	013401	100	.05	

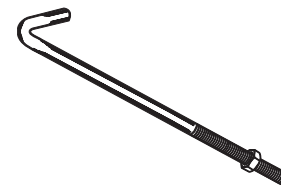

Barb Wire Stretch Bolt / With Nut, Galvanized - Steel

DESCRIPTION	PART NO.	PER SACK	WEIGHT EA.	NOTES
5/16" x 5"	010725	100	.10	

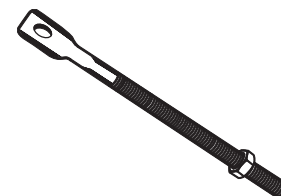

Turnbuckles / Eye and Eye • Zinc Plated Steel End Fittings

DESCRIPTION	PART NO.	PER SACK	WEIGHT EA.	NOTES
3/8" x 6" Malleable body	013451	100	.50	
3/8" x 6" Aluminum body	013452	100	.36	

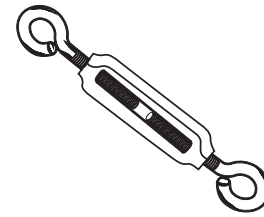

Kwik Bolt Fasteners / Interlocking wedge action provides maximum contact with masonry

DESCRIPTION	PART NO.	PER CASE	WEIGHT EA.	NOTES
3/8" x 3-3/4"	011244	100	.50	
1/2" x 2-3/4"	010746	50	.50	
1/2" x 3-3/4"	010748	50	.50	

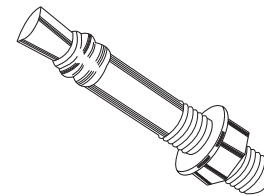

Floor Flanges / Steel • Weld -on- type with 11/16" holes

DESCRIPTION	PART NO.	PER SACK	WEIGHT EA.	NOTES
4" x 4" x 3/16" ungalv.	774P00	10	0.70	
6" x 6" x 1/4" ungalv.	010865	10	2.35	
8" x 8" x 1/4" ungalv.	010866	10	4.41	
4" x 4" x 1/4" galv.	010873	10	2.50	
6" x 6" x 1/4" galv.	010868	10	2.50	
8" x 8" x 1/4" galv.	010869	10	4.56	
3" x 6" x 1/4" galv.	010867	25	1.10	

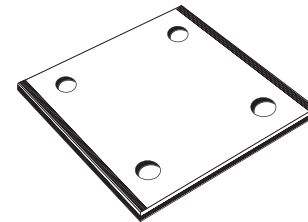

E-Z Anchors / Effective Drive Anchor To Set Posts Immediately

DESCRIPTION	PART NO.	PER CASE	WEIGHT EA.	NOTES
1-5/8"	012330	25	1.25	
1-5/8" UPC	087089	25	1.41	
1-7/8"	012335	25	1.50	
2-3/8"	012340	25	1.75	
2-3/8" UPC	087091	25	1.41	

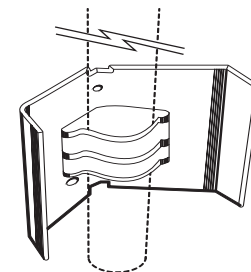

Protective Coatings / Aerosol Spray Can

DESCRIPTION	PART NO.	PER CASE	WEIGHT EA.	NOTES
Cold Galvanize, 14 oz. - dull gray color	012321	12'	1.25	
Zinc Brite, 12.5 oz. - bright silver color	036412	12	1.00	
Silver Paint, 12.5 oz.	012320	12	1.25	



High Tensile Barb Wire / Class 3 Galvanized • Meets ASTM A 121

DESCRIPTION	PART NO.	QTY. PER REEL	WEIGHT EA.	NOTES
4 pt. 15-1/2 ga. 5" Barb Spacing	013511	1320'	43.00	

NOTE: Sold only in full reels. 1320' = 80 Rods

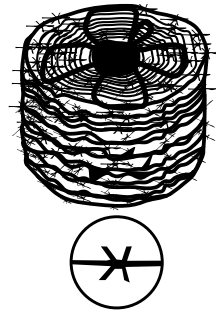

Barb Wire, Spec / Class 3 Galvanized • Meets ASTM A 121

DESCRIPTION	PART NO.	QTY. PER REEL	WEIGHT EA.	NOTES
4 pt. 12-1/2 ga. 5" Barb Spacing	013526	1320'	88.00	

NOTE: Sold only in full reels. 1320' = 80 Rods

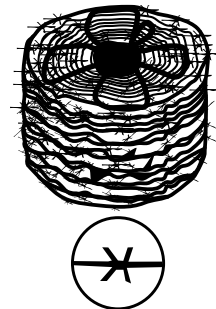

Aluminized Barb Wire, Spec / Steel • Meets ASTM A 121

DESCRIPTION	PART NO.	QTY. PER REEL	WEIGHT EA.	NOTES
4 pt. 12-1/2 ga. 5" Barb Spacing	013522	1320'	81.00	

NOTE: Sold only in full reels. 1320' = 80 Rods

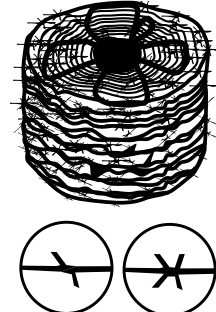

Barb Wire, Non-Spec / Commercial Galvanized

DESCRIPTION	PART NO.	QTY. PER REEL	WEIGHT EA.	NOTES
2 pt. 12-1/2 ga.	013502	1320'	69.00	
4 pt. 12-1/2 ga.	013501	1320'	77.00	

NOTE: Sold only in full reels. 1320' = 80 Rods

NOTE: Non-spec Barb Wire will void systems warranties.

Barbed Obstacle Wire / Stainless Steel Barbed Tape with .098" Galvanized Core Wire .80 oz./ft² Zinc Coating

DESCRIPTION	PART NO.	LENGTH PER ROLL	COIL WEIGHT	NOTES
Single Coil Galv Core 33 loops 18" loop spacing	013515	50'	12.00	
Single Coil Galv Core 33 loops 24" loop spacing	013514	50'	18.20	

NOTE: Sold only in 50' coils; 50' based on installation at 18" on center spacing. Bulk packaging - 5 coils per box.

LIMITATIONS: The manufacturer recommends the installation of barbed tape obstacle on fences or walls that have a minimum height of 7 feet; or installed in such a manner as to avoid contact by all pedestrian traffic.



Barbed Obstacle Wire - Specialty Use / Stainless Steel Barbed Tape with .098" Galvanized Core Wire, .80 oz./ft² Zinc Coating

DESCRIPTION	PART NO.	COIL LENGTH	COIL WEIGHT	NOTES
18" Maze Galv Core 31L	013535	15'	12.00	
24" Maze Galv Core 31L	007676	20'	29.00	
24"/30" Maze Galv Core 31L	013552	20'	39.00	
24" Maze SS Core 31L	006954	20'	38.00	
30" Maze SS Core 31L	007172	20'	22.00	
30" Super Maze SS Core 51L	005801	25'	32.00	

NOTE: Sold only in full coils. Bulk packaging - 5 coils per box

LIMITATIONS: The manufacturer recommends the installation of barbed tape obstacle on fences or walls that have a minimum height of 7 feet; or installed in such a manner as to avoid contact by all pedestrian traffic.



Coil Spring Tension Wire, Spec / Class 1 Galvanized • Meets ASTM 824

DESCRIPTION	PART NO.	FT. PER LB.	COIL LENGTH	COIL WEIGHT	NOTES
7 ga. .80 zinc coating - Priced per lb.	023541	12'	—	100.00	
7 ga. .80 zinc coating - Priced by coil	023499	12'	1020'	85.00	

NOTE: Weights are approximate.



Coil Spring Tension Wire, Spec / Class 2 Galvanized • Meets ASTM 824

DESCRIPTION	PART NO.	FT. PER LB.	COIL LENGTH	COIL WEIGHT	NOTES
7 ga. 1.2 zinc coating - Priced by coil	023505	12'	1020'	85.00	

NOTE: Sold only in full coils. Weights are approximate.

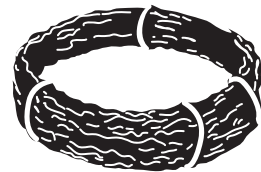

Coil Spring Tension Wire, Spec / Meets ASTM 824, Type 1

DESCRIPTION	PART NO.	FT. PER LB.	COIL LENGTH	COIL WEIGHT	NOTES
7 ga. 40 aluminized - Priced by coil	023540	12'	1000'	85.00	

NOTE: Sold only in full coils. Weights are approximate.



Smooth Tension Wire, Spec / Class 3 Galvanized • Meets ASTM A 641

DESCRIPTION	PART NO.	FT. PER LB.	COIL LENGTH	COIL WEIGHT	NOTES
6 ga., 1.00 zinc coating - priced per lb	023500	10-3/4'	—	100.00	
9 ga., .90 zinc coating - priced per lb.	023501	17'	—	100.00	
9 ga., .90 zinc coating UPC - priced by coil	087025	17'	170'	10.00	
10 ga., .85 zinc coating - priced per lb.	023511	17'	—	100.00	
11 ga., .85 zinc coating - priced per lb.	023521	25-3/4'	—	100.00	
12 ga., .80 zinc coating - priced per lb.	023531	33-1/2'	—	100.00	
16 ga., .60 zinc coating - priced per lb.	023535	96'	—	100.00	

NOTE: Weights are approximate.

NOTE: Non-spec Tension Wire will void systems warranties.

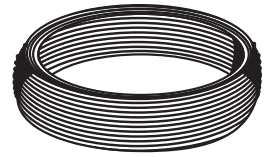

Barbless Wire / Class 1 Galvanized

DESCRIPTION	PART NO.	REEL LENGTH	REEL WEIGHT	NOTES
12-1/2 ga.	013531	1320'	62.00	
14 ga.	013532	1320'	44.00	

NOTE: Sold only in full reels.

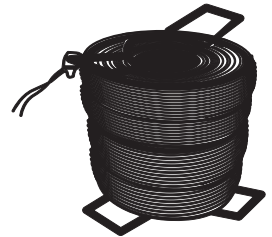

Hog Rings / Steel • Class 3 • Meets ASTM F 626

DESCRIPTION	PART NO.	QTY. PER LB.	CASE WEIGHT	NOTES
12-1/2 ga. .80 zinc coating	023601	224	25.00	
12-1/2 ga. .80 zinc coating UPC	087037	88	25.00	
9 ga. .90 zinc coating	023602	88	25.00	

NOTE: Weights are approximate.

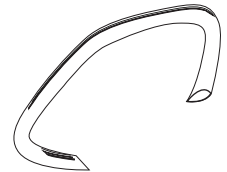

Hog Rings / Meets ASTM F 626

DESCRIPTION	PART NO.	QTY. PER LB.	CASE WEIGHT	NOTES
9 ga. Aluminum	023621	264	10.00	
9 ga. Stainless Steel	003765	169	25.00	

NOTE: Weights are approximate.

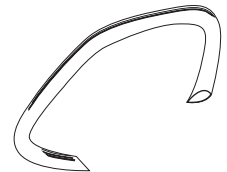

Malco Hog Rings / Weight is approximate. *Meets ASTM A 641

DESCRIPTION	PART NO.	QTY. PER LB.	BOX WEIGHT	NOTES
9 ga. Galvanized Steel Class 3*	664C00	500	6.00	
9 ga. Aluminum	665C00	500	2.00	
Malco Hog Ring Plier	661C00	N/A	2.90/ea	

NOTE: Malco hog rings and pliers cannot be used with non-Malco hog rings or hog ring tools

NOTE: Weights are approximate.

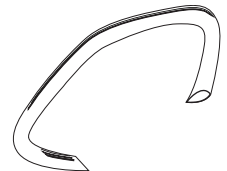

Carriage Bolt - Domestic / With Nut, Steel

DESCRIPTION	PART NO.	PER CASE	WEIGHT EA.	NOTES
5/16" x 1-1/4"	10701D	2000	.039	

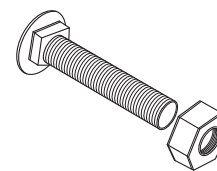

Floor Flanges - Domestic / Steel • Weld-on- type with 11/16" holes

DESCRIPTION	PART NO.	PER SACK	WEIGHT EA.	NOTES
4" x 4" x 1/4" galv.	034C00	10	1.00	
6" x 6" x 1/4" galv.	10868D	10	2.50	
8" x 8" x 1/4" galv.	453Y00	10	5.00	

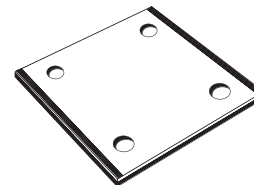

High Tensile Barb Wire - Domestic / Class 3 Galvanized • Meets ASTM A 121

DESCRIPTION	PART NO.	REEL LENGTH	WEIGHT EA.	NOTES
4 pt. 15-1/2 ga. 3" Barb Spacing	408W00	1320'	81.00	
4 pt. 15-1/2 ga. 5" Barb Spacing	013499	1320'	45.00	

NOTE: Sold only in full reels. 1320' = 80 Rods.

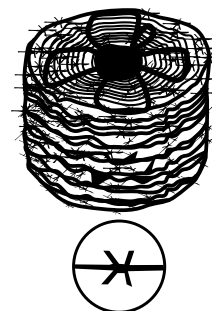

Barb Wire - Domestic / Class 3 Galvanized • Meets ASTM A 585, Type I

DESCRIPTION	PART NO.	REEL LENGTH	WEIGHT EA.	NOTES
4 pt. 12-1/2 ga. 5" Barb Spacing	013505	1320'	88.00	

NOTE: Sold only in full reels. 1320' = 80 Rods.

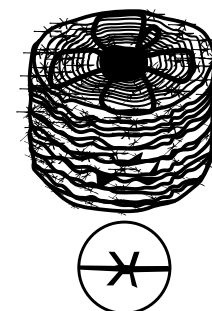

Barb Wire - Domestic / Class 3 Galvanized • Meets ASTM A 121

DESCRIPTION	PART NO.	REEL LENGTH	WEIGHT EA.	NOTES
2 pt. 12-1/2 ga. 4" Barb Spacing	006321	1320'	82.00	
4 pt. 12-1/2 ga. 5" Barb Spacing	013506	1320'	88.00	

NOTE: Sold only in full reels. 1320' = 80 Rods

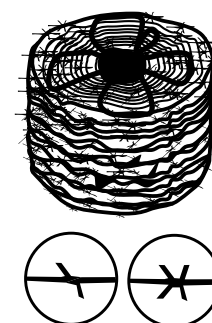

Barb Wire - Domestic / Class 1 Galvanized

DESCRIPTION	PART NO.	REEL LENGTH	WEIGHT EA.	NOTES
2 pt. 12-1/2 ga. 5" Barb Spacing	013504	1320'	78.00	

NOTE: Sold only in full reels. 1320' = 80 Rods

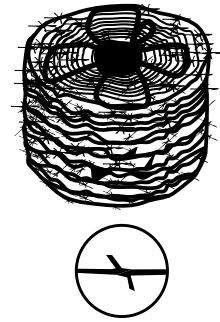

Barb Wire - Domestic / Commercial Galvanized

DESCRIPTION	PART NO.	REEL LENGTH	WEIGHT EA.	NOTES
4 pt. 12-1/2 ga.	013503	1320'	82.00	

NOTE: Sold only in full reels. 1320' = 80 Rods

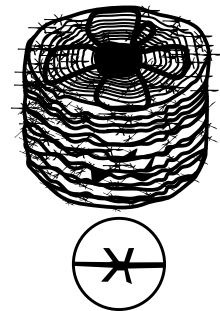

Coil Spring Tension Wire - Domestic / Class 1

DESCRIPTION	PART NO.	FT. PER LB.	COIL LENGTH	COIL WEIGHT	NOTES
7 ga. .80 zinc coating	23499D	12'	1020'	85.00	

NOTE: Sold only in full coils. Weights and feet per pound are approximate.



Hog Rings - Domestic / Aluminum • Meets ASTM F 626

DESCRIPTION	PART NO.	QTY. PER LB.	CASE WEIGHT	NOTES
9 ga.	23621D	264	10.00	

NOTE: Weights are approximate.



Carriage Bolt - Spectra / With Nut, Steel

DESCRIPTION	PART NO.	PER BOX	WEIGHT EA.	NOTES
5/16" x 1-1/4"	62201_	100	.06	

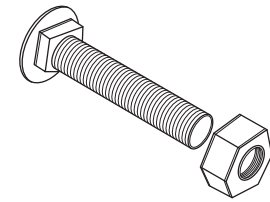

Tek Screw - Spectra / Self-Drilling, Self-Tapping, Zinc-Plated Steel

DESCRIPTION	PART NO.	PER LB.	WEIGHT EA.	NOTES
No. 12 x 3/4" - Black	166X00	100	.01	



Barb Wire - Spectra / Zinc Coated Steel, Polymer Coating • Meets ASTM F 1665 Class 1

DESCRIPTION	PART NO.	REEL LENGTH	REEL WEIGHT	NOTES
4 pt. 5" Barb Spacing Extruded PVC, Type I	48157_	1320'	70.00	

NOTE: Sold only in full reels.

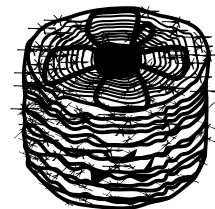

Barb Wire - Permafused / Zinc Coated Steel, Polymer Coating • Meets ASTM F 1665 Class 2b

DESCRIPTION	PART NO.	REEL LENGTH	REEL WEIGHT	NOTES
4 pt. 3" Barb Spacing Fused and Adhered, Type II	48157_	1320'	70.00	

NOTE: Sold only in full reels.

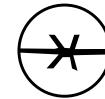

Coil Spring Tension Wire - Heavy Mil / .80 Zinc Coated Steel

DESCRIPTION	PART NO.	PER LB.	ROLL LENGTH	ROLL WEIGHT	NOTES
9ga. core/6ga. finish - priced by roll	48060_	15-5/8'	1000'	64.00	

NOTE: Sold only in full coils. Weight and feet per pound are approximate.



Smooth Tension Wire - Heavy Mil / Commercial Galvanized

Non-spec Tension Wire will void systems warranties.

DESCRIPTION	PART NO.	PER LB.	COIL LENGTH	COIL WEIGHT	NOTES
9ga. finish - priced per lb.	51001_	34'	—	100.00	
9ga. finish - priced by coil	51002_	34'	340'	10.00	
6ga. finish - priced per lb.	51000_	15'	—	100.00	

NOTE: Sold only in full coils. Weight and feet per pound are approximate.



Add the following number to the part no. for desired color:

1-Forest Green 2-Midnight Black 3-Sierra Brown

Hog Ring, Spec - Heavy Mil / Zinc-coated Aluminum Core

DESCRIPTION	PART NO.	PER BAG	BAG WEIGHT	NOTES
11-1/2 ga. core / 9 ga. finish	62485_	500	1.60	



Hog Ring, Non-Spec - Heavy Mil / Zinc-coated Steel Core

DESCRIPTION	PART NO.	PER LB.	WEIGHT	NOTES
9 ga. finish	62482_	132	1.00	



Touch Up Paint

DESCRIPTION	PART NO.	WEIGHT EA.	NOTES
13 oz. Aerosol Spray Can	62606_	1.40	



Add the following number to the part no. for desired color:
1-Forest Green 2-Midnight Black 3-Sierra Brown

Frame Hinges / Regular • Pressed Steel – Galvanized

DESCRIPTION	PART NO.	PER SACK	WEIGHT EA.	NOTES
1-3/8" x 1/2"	014103	100	.28	
1-3/8" x 5/8"	014104	100	.31	

Use 3/8" x 2" Carriage Bolt – Pt. #010706

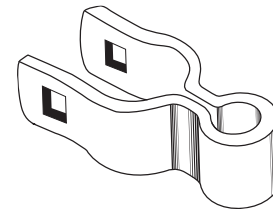

Frame Hinges / Heavy Duty • Pressed Steel – Galvanized

DESCRIPTION	PART NO.	PER SACK	WEIGHT EA.	NOTES
1-3/8" x 5/8"	014108	100	.38	
1-5/8" x 1/2"	014107	50	.52	
1-5/8" x 5/8"	014105	50	.52	
1-7/8" x 5/8"	014106	50	.54	

Use 3/8" x 2-1/4" Carriage Bolt – Pt. #010707

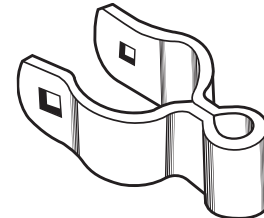

Post Hinges / Regular • Pressed Steel – Galvanized

DESCRIPTION	PART NO.	PER SACK	WEIGHT EA.	NOTES
1-3/8" x 5/8"	014302	50	.44	

Use 3/8" x 2" Carriage Bolt – Pt. #010706

1-7/8" x 5/8" 014326 50 .51

Use 3/8" x 2-1/4" Carriage Bolt – Pt. #010707

2-3/8" x 5/8" 014328 50 .56

Use 3/8" x 3" Carriage Bolt – Pt. #010710

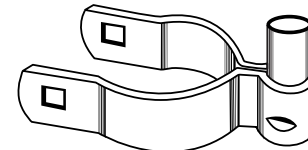

Post Hinges / Heavy Duty • Pressed Steel – Galvanized

DESCRIPTION	PART NO.	PER SACK	WEIGHT EA.	NOTES
1-5/8" x 5/8"	014304	50	.76	
1-7/8" x 1/2"	014305	50	.70	
1-7/8" x 5/8"	014306	50	.80	

Use 3/8" x 2-1/4" Carriage Bolt – Pt. #010707

2-3/8" x 1/2" 014307 50 .80

2-3/8" x 5/8" 014308 50 .82

Use 3/8" x 3" Carriage Bolt – Pt. #010710

2-7/8" x 5/8" 014310 50 1.11

Use 3/8" x 3-1/2" Carriage Bolt – Pt. #010712

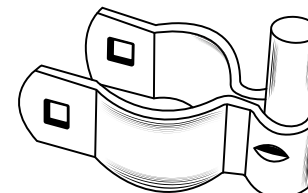

Flat-Back Hinge / Pressed Steel – Galvanized

DESCRIPTION	PART NO.	PER SACK	WEIGHT EA.	NOTES
Flat Plate Pin Hinge with 1-1/2" x 4" Steel Plate	014360	100	.45	

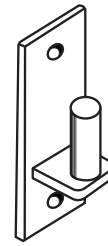

Single Swing Gate Hardware Sets / Pressed Steel – Galvanized

DESCRIPTION	PART NO.	PER CASE	WEIGHT EA.	NOTES
1-7/8" x 1-3/8"	087068	6	3.20	
2-3/8" x 1-3/8"	087079	6	3.31	

Includes 2 Frame Hinges, 2 Post Hinges, 1 Fork Latch Assembly, Bolts.

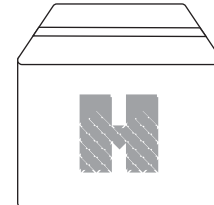

Double Swing Gate Hardware Sets / Pressed Steel – Galvanized

DESCRIPTION	PART NO.	PER SACK	WEIGHT EA.	NOTES
1-7/8" x 1-3/8"	087069	6	4.28	
2-3/8" x 1-3/8"	087080	6	4.45	

Includes 4 Frame Hinges, 4 Post Hinges, Bolts. Without Latch.

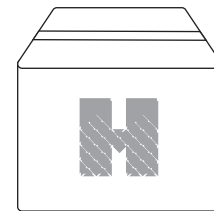

TruClose Hinge by D&D / Black Polymer • Includes fasteners

DESCRIPTION	PART NO.	PER SACK	WEIGHT PR.	NOTES
2-3/8 to 2-7/8 x 1-5/8 to 1-7/8 TCHDRND1-MK2	198012	10	2.20	

NOTE: Requires 1" spacing between Gate Post and Gate Frame.

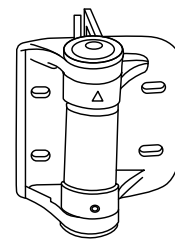

Gate Closers / Spring Type • Die-Cast Aluminum • Includes bolts

DESCRIPTION	PART NO.	PER SACK	WEIGHT EA.	NOTES
1-7/8" x 1-3/8"	017403	12	1.00	
2-3/8" x 1-3/8"	017404	12	1.10	

NOTE: Requires 2" spacing between Gate Post and Gate Frame. Use with Post and Frame Hinges (sold separately).

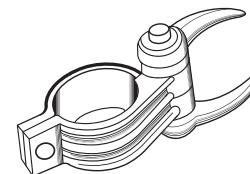

Gate Hinge Closers / Gravity Type • Pressed Steel - Galvanized • Includes bolts

DESCRIPTION	PART NO.	PER SACK	WEIGHT EA.	NOTES
1-7/8" x 1-3/8"	017501	10	2.79	
2-3/8" x 1-3/8"	017502	10	2.92	

NOTE: Requires 2" spacing between Gate Post and Gate Frame.

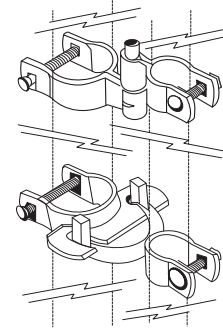

STA-KLOS Gate Closers / Steel

DESCRIPTION	ART NO.	PER SACK	WEIGHT EA.	NOTES
1-7/8" x 1-3/8"	017402	12	1.60	
2-3/8" x 1-3/8"	017405	12	1.64	

Use with Post and Frame Hinges (sold separately).

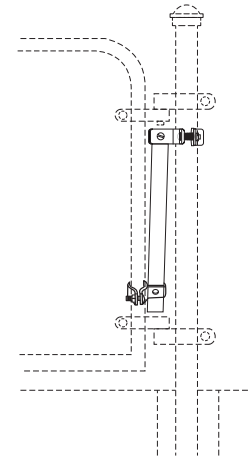

Hanger Bolt Hinges / Galvanized - Steel • Includes 2 nuts

DESCRIPTION	PART NO.	PER DRUM	WEIGHT EA.	NOTES
1/2" x 4-1/2"	013901	400	.43	
1/2" x 6"	013902	350	.50	
5/8" x 4-1/2"	013903	250	.64	
5/8" x 6"	013904	200	.74	
5/8" x 8"	013907	150	.84	
5/8" x 10"	013905	125	1.07	
5/8" x 12"	013906	125	1.23	

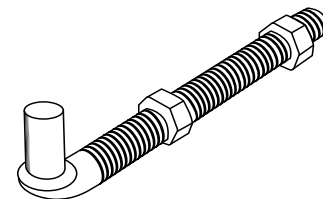

Lag Screw Hinges / Galvanized - Steel

DESCRIPTION	PART NO.	PER DRUM	WEIGHT EA.	NOTES
1/2" x 4-1/2"	013801	400	.32	
5/8" x 4-1/2"	013802	300	.52	
5/8" x 6"	013803	250	.62	

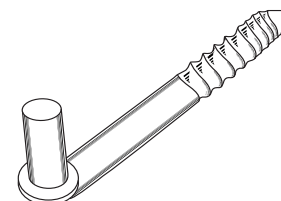

180° Industrial Hinges / Pressed Steel – Galvanized

DESCRIPTION	PART NO.	PER SACK	WEIGHT EA.	NOTES
2-3/8" x 1-5/8" or 1-7/8"	015601	10	3.00	
2-7/8" x 1-5/8" or 1-7/8"	015603	10	3.20	
3-1/2" x 1-5/8" or 1-7/8"	015604	10	4.00	
4" x 1-5/8" or 1-7/8"	015605	10	4.20	
4-1/2" x 1-5/8" or 1-7/8"	015606	10	4.50	
6-5/8" x 1-5/8" or 1-7/8"	015607	4	6.00	
8-5/8" x 1-5/8" or 1-7/8"	015609	4	9.00	

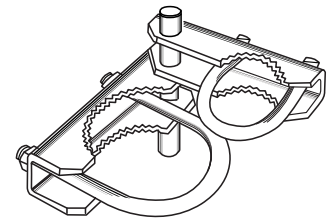

Offset 180° Industrial Hinges / Malleable Iron – Galvanized

DESCRIPTION	PART NO.	PER SACK	WEIGHT EA.	NOTES
2-3/8" x 1-5/8" or 1-7/8"	014033	4	3.52	
2-7/8" x 1-5/8" or 1-7/8"	014034	4	3.85	
4" x 1-5/8" or 1-7/8"	014036	4	4.62	
6-5/8" x 1-5/8" or 1-7/8"	014038	4	8.00	

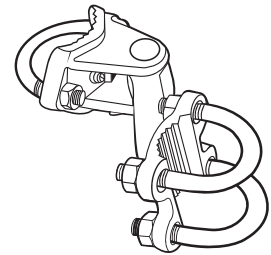

Bulldog Industrial Hinges / Pressed Steel – Galvanized

DESCRIPTION	PART NO.	PER SACK	WEIGHT EA.	NOTES
2-3/8" x 1-5/8" or 1-7/8"	015671	10	3.20	
2-7/8" x 1-5/8" or 1-7/8"	015672	10	3.30	
4" x 1-5/8" or 1-7/8"	015674	10	3.70	
4-1/2" x 1-5/8" or 1-7/8"	015675	10	3.90	
6-5/8" x 1-5/8" or 1-7/8"	015676	4	5.90	

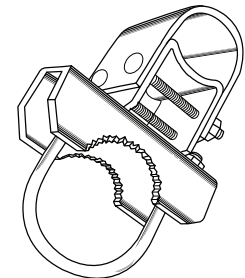

Box Industrial Hinges / Malleable Iron – Galvanized

DESCRIPTION	PART NO.	PER SACK	WEIGHT EA.	NOTES
2-3/8" x 1-5/8" or 1-7/8"	015751	4	3.70	
2-7/8" x 1-5/8" or 1-7/8"	015752	4	4.10	
4" x 1-5/8" or 1-7/8"	015754	4	4.50	
6-5/8" x 1-5/8" or 1-7/8"	015756	4	11.50	
8-5/8" x 1-5/8" or 1-7/8"	015757	4	16.68	

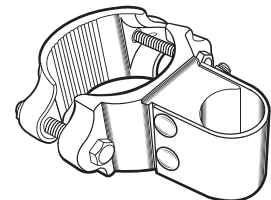

Steel Gate Hinges / Pressed Steel – Galvanized

DESCRIPTION	PART NO.	PER SACK	WEIGHT EA.	NOTES
2-3/8" x 1-5/8"	015622	10	3.50	
2-7/8" x 1-5/8"	015624	10	3.70	
2-7/8" x 1-7/8"	015625	10	4.00	
3-1/2" x 1-5/8"	015626	10	4.20	
4" x 1-5/8"	015628	10	4.50	
4" x 1-7/8"	015629	10	4.50	
4-1/2" x 1-5/8"	015630	10	4.70	
4-1/2" x 1-7/8"	015631	10	4.70	
6-5/8" x 1-7/8"	015633	6	7.00	
8-5/8" x 1-7/8"	015635	4	8.00	

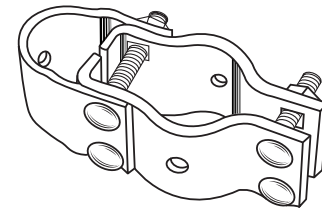

180° Offset Adapter / Malleable Iron – Galvanized • Includes U-bolts

DESCRIPTION	PART NO.	PER SACK	WEIGHT EA.	NOTES
1-5/8" or 1-7/8" Gate Frame	015715	10	5.00	

NOTE: Use with 1-7/8" Nosepiece on Industrial Box, Bulldog, and Steel Gate Hinges.

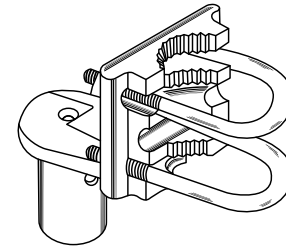

Socket Hinge Plugs / Malleable Iron – Galvanized

DESCRIPTION	PART NO.	PER SACK	WEIGHT EA.	NOTES
1-5/8" Gate Frame	015719	10	1.30	
1-7/8" Gate Frame	015720	10	1.50	

NOTE: Use with Industrial Box, Bulldog, and Steel Gate Hinges

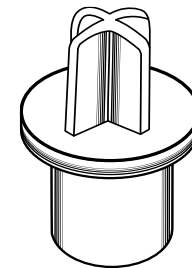

Magna Latches by D&D / Black Polymer

DESCRIPTION	PART NO.	PER SACK	WEIGHT EA.	NOTES
Top Pull - S3	009449	10	1.71	
Vertical Pull - S3	009450	10	1.38	
Round Post Adapter - S3	814X00	10	0.40	

NOTE: The Round Post Adapter fits a 1-3/8" to 1-5/8" gate frame and a 1-7/8" to 2-7/8" post.

Top Pull

Vertical Pull

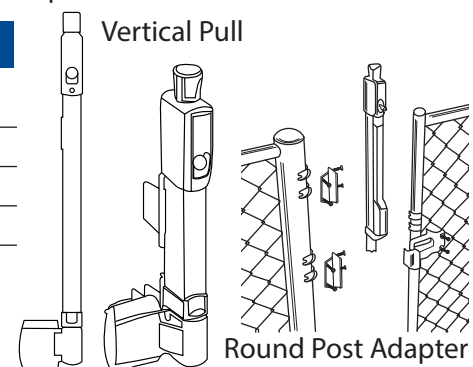

Round Post Adapter

Fork Latch Assembly / Regular • Pressed Steel – Galvanized • Includes bolts

DESCRIPTION	PART NO.	PER SACK	WEIGHT EA.	NOTES
1-3/8" x 1-3/8"	016703	25	.88	
1-3/8" x 1-7/8"	016704	25	.86	
1-3/8" x 2-3/8"	016705	25	.88	
1-3/8" x 2-7/8"	016706	25	1.30	

NOTE: This item is assembled.

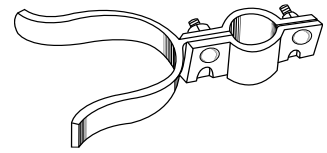

Fork Latch Assembly / Heavy Duty • Pressed Steel – Galvanized • Includes bolts

DESCRIPTION	PART NO.	PER SACK	WEIGHT EA.	NOTES
1-3/8" x 1-7/8"	016752	25	0.90	
1-3/8" x 2-3/8"	016753	25	1.02	
1-3/8" x 2-7/8"	016754	25	1.08	
1-5/8" x 1-7/8"	016756	25	0.98	
1-5/8" x 2-3/8"	016757	25	1.00	
1-5/8" x 2-7/8"	016758	25	1.08	
1-5/8" x 4"	016759	25	1.20	

NOTE: This item is assembled.

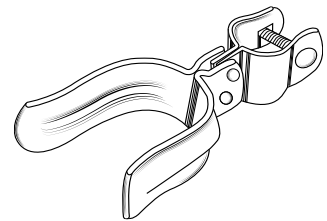

Fork Latch Assembly / Malleable Iron – Galvanized • Includes bolts

DESCRIPTION	PART NO.	PER SACK	WEIGHT EA.	NOTES
1-3/8" x 1-7/8"	016601	25	1.40	
1-3/8" x 2-3/8"	016602	25	1.45	
1-3/8" x 2-7/8"	016603	25	1.55	
1-5/8" x 1-7/8"	016604	25	1.50	
1-5/8" x 2-3/8"	016605	25	1.55	
1-5/8" x 2-7/8"	016606	25	1.61	
1-5/8" x 4"	016607	25	1.89	
1-7/8" x 2-3/8"	016613	20	1.54	
1-7/8" x 2-7/8"	016608	20	1.65	
1-7/8" x 4"	016609	20	1.90	

NOTE: This item is assembled.

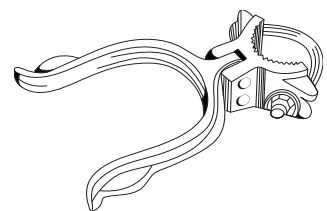

Flat-Back Fork Latch Assembly / Pressed Steel - Galvanized • Includes bolt

DESCRIPTION	PART NO.	PER SACK	WEIGHT EA.	NOTES
1-3/8" Fork	016710	25	.56	

NOTE: This item is assembled. Without mounting fasteners.

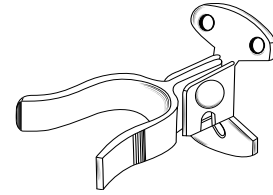

Fork Latch Hangers (Collars) / Regular • Pressed Steel - Galvanized

DESCRIPTION	PART NO.	PER SACK	WEIGHT EA.	NOTES
1-3/8"	016731	100	.43	
1-5/8"	016732	100	.50	
1-7/8"	016733	100	.56	

Use 5/16" x 1-1/4" Carriage Bolt - Pt. #010701

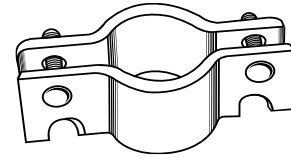

Forks / Regular • Pressed Steel - Galvanized

DESCRIPTION	PART NO.	PER SACK	WEIGHT EA.	NOTES
1-3/8"	016716	100	.32	
1-5/8"	016715	100	.34	
1-7/8"	016717	100	.34	
2-3/8"	016718	100	.42	
2-7/8"	016719	100	.48	
4"	016720	100	.56	
6-5/8"	016730	50	.60	

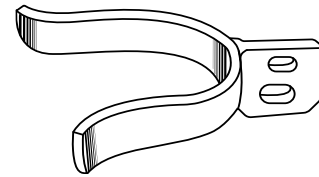

Forks / Heavy Duty • Pressed Steel - Galvanized

DESCRIPTION	PART NO.	PER SACK	WEIGHT EA.	NOTES
1-5/8"	016722	50	.35	
2-7/8"	016725	50	.52	
4"	016727	50	.80	

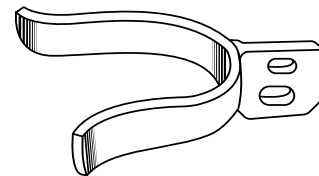

Auto Latches / Glass-Filled Nylon Plastic

DESCRIPTION	PART NO.	PER SACK	WEIGHT EA.	NOTES
1-3/8" x 1-3/8"	017300	1	1.00	
1-3/8" x 1-7/8"	017301	1	1.00	
1-3/8" x 2-3/8"	017302	1	1.00	
1-5/8" x 2-3/8"	017305	1	2.00	
1-5/8" x 2-7/8"	017370	1	1.00	

Other sizes available on special quotation.

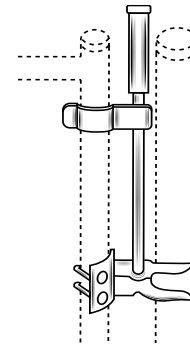

Butterfly Latches / Pressed Steel Ear, Aluminum Back • Includes bolts

DESCRIPTION	PART NO.	PER SACK	WEIGHT EA.	NOTES
1-3/8" x 1-7/8"	017303	25	0.89	
1-3/8" x 2-3/8"	017304	25	0.90	
1-5/8" x 1-7/8"	017306	25	1.04	
1-5/8" x 2-3/8"	017307	25	1.07	

NOTE: This item is assembled.

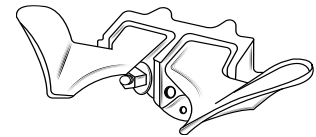

Flat-Back Butterfly Latch / Pressed Steel – Galvanized

DESCRIPTION	PART NO.	PER SACK	WEIGHT EA.	NOTES
1-3/8" Gate Frame	017310	25	0.88	

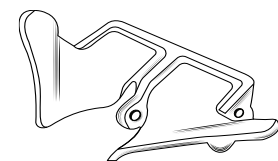

Spring Latches / Pressed Steel – Galvanized

DESCRIPTION	PART NO.	PER SACK	WEIGHT EA.	NOTES
1-3/8" Gate Frame	016101	25	0.68	
Universal Latch Catch	016401	25	0.17	
2-3/8" Latch Catch	016202	25	0.36	

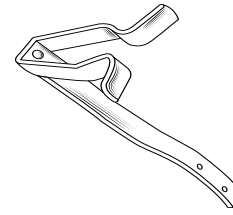

E-Z Latches / Galvanized Steel Rod & Guides, Aluminum Fork

DESCRIPTION	PART NO.	PER SACK	WEIGHT EA.	NOTES
1-3/8" x 36" Assembly	016901	10	2.17	
1-3/8" x 42" Assembly	016902	10	2.31	
(Assembly includes: 1 Rod w/ Fork, 2 Guides, with Bolts)				
5/8" x 36" Rod Only with Fork	016921	10	1.25	
5/8" x 42" Rod Only with Fork	016922	10	1.41	
E-Z Latch Guide Only with Bolt	016903	20	0.44	

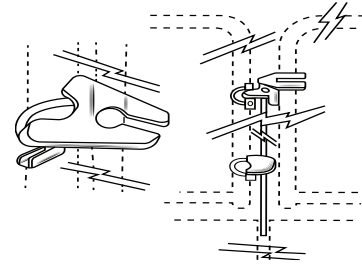

Residential Cane-Type Latches / Steel Rod & Guides – Galvanized

DESCRIPTION	PART NO.	PER SACK	WEIGHT EA.	NOTES
1-3/8" x 36" Assembly	016905	25	2.88	
1-3/8" x 44" Assembly	016906	25	3.29	
1/2" x 44" Assembly	087051	10	3.36	
(Assembly includes: 1 Rod w/ Fork, 2 Guides, Bolts)				
1/2" x 30" Rod Only	016913	25	1.81	
1/2" x 36" Rod Only	016909	25	2.14	
1/2" x 44" Rod Only	016911	25	2.56	
Cane-Type Guide Only	016915	50	0.29	

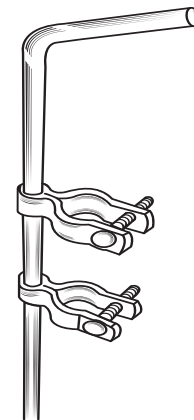

Industrial Latches / Pressed Steel – Galvanized

DESCRIPTION	PART NO.	PER SACK	WEIGHT EA.	NOTES
1-5/8" Assembly	017201	10	4.80	
1-7/8" Assembly	017202	10	4.98	
Assembly includes: 1 Fork, 3 Guides, Bolts. Drop Rod not included.				
1-5/8" Guide Only	017211	75	0.99	
Use 3/8" x 2-1/4" Carriage Bolt – Pt. #010707				
1-7/8" Guide Only	017212	75	1.05	
Use 3/8" x 2-1/2" Carriage Bolt – Pt. #010708				
1-5/8" Fork Only	017213	25	1.54	
1-7/8" Fork Only	017214	25	1.56	
1-5/8" Assembly with Drop Rod	017217	10	12.00	
1-7/8" Assembly with Drop Rod	017218	10	12.00	

Assembly with Drop Rod includes: Fork, 3 Guides, Bolts, 1-3/8" x 7' Drop Rod – with Fork welded to Rod.

NOTE: Optional with 4 Guides and 2 Forks at extra cost.

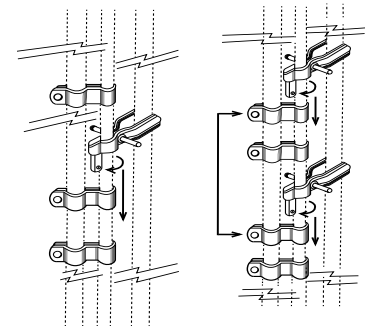

Frost Free Latch Assembly / For Double Swing Gates • Malleable Iron – Galvanized

DESCRIPTION	PART NO.	PER SACK	WEIGHT EA.	NOTES
1-5/8" Gate Frame	017205	10	2.83	
1-7/8" Gate Frame	017206	10	2.98	

NOTE: Does not require Drop Rod.

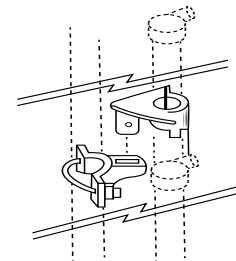

Fence-Loc Latches / Pressed Steel – Galvanized

DESCRIPTION	PART NO.	PER CARTON	WEIGHT EA.	NOTES
1-3/8" Gate Frame	017223	30	2.23	
1-5/8" or 1-7/8" Gate Frame	017221	15	4.50	

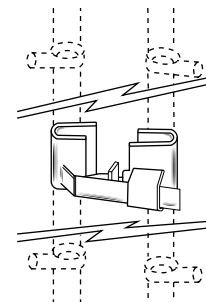

Strong Arm Latches / Galvanized Steel

DESCRIPTION	PART NO.	PER SACK	WEIGHT EA.	NOTES
2-3/8" Post	017225	12	5.50	
2-7/8" Post	017226	12	5.50	
4" Post	017227	12	5.50	

For single swing gates - latches fit 1-5/8" or 1-7/8" gate frames.

1-3/8" Gate Frame	017233	6	4.00	
1-5/8" or 1-7/8" Gate Frame	017219	6	8.30	

For double swing gates.

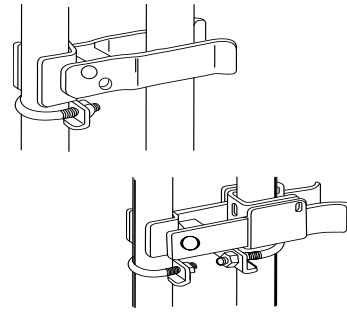

Rolo Latches / For Rolling Gates • Pressed Steel – Galvanized

DESCRIPTION	PART NO.	PER SACK	WEIGHT EA.	NOTES
1-5/8" Frame	017410	10	2.35	
1-7/8" Frame	017420	10	2.39	

NOTE: Use with two 1/8" x 1" Brace Bands (sold separately).
Pat. No. 3,871,134

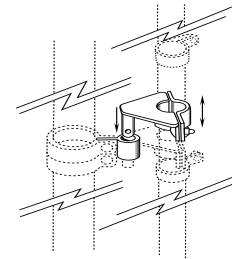

Lock N' Latch / For Rolling Gates • Heavy Duty • Pressed Steel – Galvanized

DESCRIPTION	PART NO.	PER SACK	WEIGHT EA.	NOTES
Offset	017371	10	1.50	

Latches to 1-5/8" or 1-7/8" O.D. Frame – For Single Rolling Gate

Standard	017372	10	1.50	
----------	--------	----	------	--

Latches to 1-5/8" or 1-7/8" O.D. Frame – For Single or Double Rolling Gate

NOTE: Use with two 1/8" x 1" Brace Bands (sold separately).
Pat. No. 3,492,036

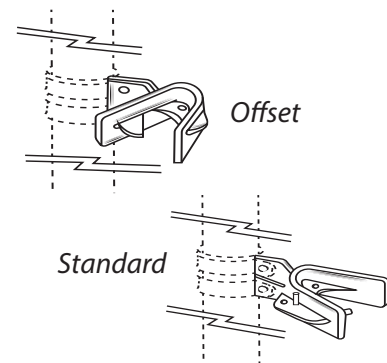

Cantilever Latches / Pressed Steel – Galvanized • Includes bolts

DESCRIPTION	PART NO.	PER SACK	WEIGHT EA.	NOTES
2-7/8" Post	017373	10	3.73	
4" Post	017374	10	4.05	
6-5/8" Post	017379	10	4.05	

NOTE: For 1-5/8" or 1-7/8" Gate Frame. Approximately 4-1/2" from face of post to center of gate frame.

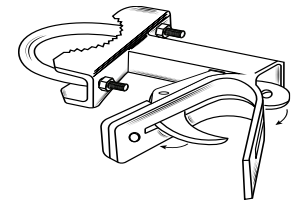

Cantilever Latches / Heavy Duty • Pressed Steel – Galvanized Use With Gate Operators

DESCRIPTION	PART NO.	BOX QTY.	WEIGHT EA.	NOTES
2-7/8" Post	017376	2	8.33	
4" Post	017377	2	8.79	

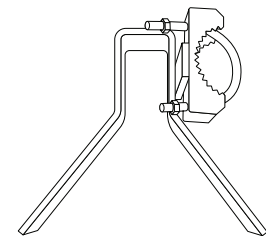

Field Type Gate Center Stop / Pressed Steel – Galvanized

DESCRIPTION	PART NO.	PER SACK	WEIGHT EA.	NOTES
Steel	015913	25	2.01	



Mushroom Type Center Stops

DESCRIPTION	PART NO.	PER SACK	WEIGHT EA.	NOTES
Aluminum	015912	5	1.70	
Malleable Iron	015911	5	3.50	

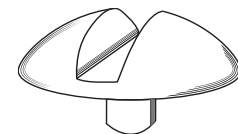

Gate Keeper / Pressed Steel – Galvanized • Includes bolts

DESCRIPTION	PART NO.	PER SACK	WEIGHT EA.	NOTES
1-5/8"	015904	20	1.00	

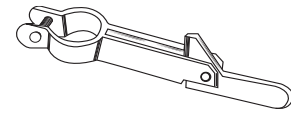

Gate Keeper / Malleable • Includes bolts

DESCRIPTION	PART NO.	PER SACK	WEIGHT EA.	NOTES
1-5/8"	015901	20	2.22	

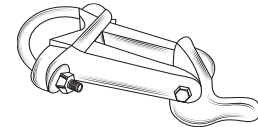

Gate Scrolls / One-Piece • Aluminum

DESCRIPTION	PART NO.	PER SACK	WEIGHT EA.	NOTES
18"	014705	25	.23	
24"	014706	25	.30	
36"	014707	25	.40	



Gate Scrolls / Three-Piece • Pressed Steel – Galvanized

DESCRIPTION	PART NO.	PER SACK	WEIGHT EA.	NOTES
18"	014501	10	1.12	
24"	014502	10	1.44	
36"	014507	10	1.50	



Lock Boxes / Ungalvanized – Steel • 2-1/8" Lock Hole

DESCRIPTION	PART NO.	PER SACK	WEIGHT	NOTES
Single Hole	018863	1	1.00	
Double Hole	018861	1	2.00	

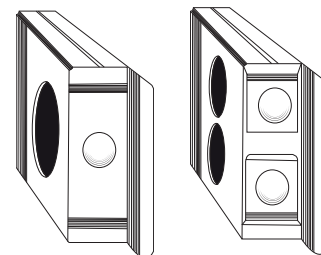

Gate Ell / Residential Hex Type • Die-Cast Aluminum • Without screws

DESCRIPTION	PART NO.	PER SACK	WEIGHT EA.	NOTES
1-3/8"	015101	100	.36	

Use No. 12 x 3/4" Tek Screw – Pt. #023660

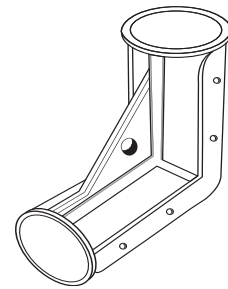

Gate Ell / Residential Bolt-On • Die-Cast Aluminum • Includes bolts • No drilling required

DESCRIPTION	PART NO.	PER SACK	WEIGHT EA.	NOTES
1-3/8"	015103	100	.45	

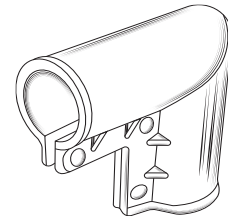

Gate Ells / Pressed Steel – Galvanized • Without rivets

DESCRIPTION	PART NO.	PER SACK	WEIGHT EA.	NOTES
1-3/8" Top	014903	50	.98	
1-3/8" Bottom	014904	50	.96	

Use 1/4" x 1-3/4" Rivet – Pt. #010776

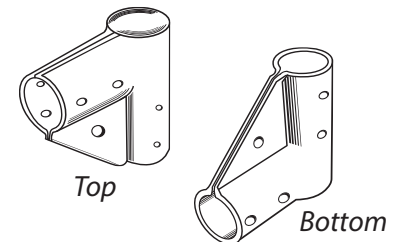

Gate Ells Industrial / Pressed Steel – Galvanized • Without rivets

DESCRIPTION	PART NO.	PER SACK	WEIGHT EA.	NOTES
1-5/8"	014901	20	2.50	

Use 5/16" x 2-1/4" Rivet – Pt. #010774

1-7/8"	014902	20	2.50	
--------	--------	----	------	--

Use 5/16" x 2-1/2" Rivet – Pt. #010772

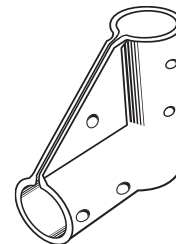

Drive-In Plugs / Sand-Cast Aluminum

DESCRIPTION	PART NO.	PER SACK	WEIGHT EA.	NOTES
1-3/8" For Tube	011210	100	.08	
1-5/8" For Tube	011211	100	.10	
1-7/8" For Tube	011212	100	.13	
2-3/8" For Tube	011219	50	.15	
1-3/8" For Pipe	011213	100	.08	
1-5/8" For Pipe	011214	100	.10	
1-7/8" For Pipe	011215	100	.13	

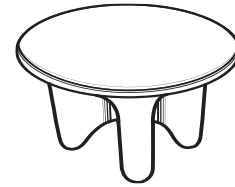

Gate Clips / Pressed Steel - Galvanized

DESCRIPTION	PART NO.	PER SACK	WEIGHT EA.	NOTES
1-3/8"	015201	250	.13	
1-3/8" C Type	015208	250	.13	
1-3/8" Qwik Clip	015200	250	.12	
1-5/8"	015205	250	.16	

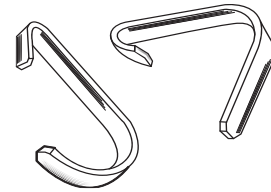

Gate Rods / 5/16" Diameter Galvanized Steel

DESCRIPTION	PART NO.	PER SACK	WEIGHT EA.	NOTES
28-3/4"	015341	25	0.65	
34-3/4"	015342	25	0.78	
40-3/4"	015343	25	0.91	
52-3/4"	015344	25	1.17	
64-3/4"	015345	25	1.43	

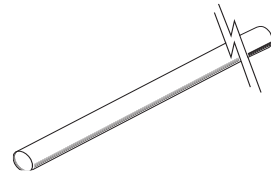

Gate Rods, Extra Long / 5/16" Diameter Galvanized Steel

DESCRIPTION	PART NO.	PER SACK	WEIGHT EA.	NOTES
31-1/2"	015411	25	0.70	
37-1/2"	015412	25	0.83	
43-1/2"	015413	25	0.96	
55-1/2"	015414	25	1.22	
67-1/2"	015415	25	1.48	

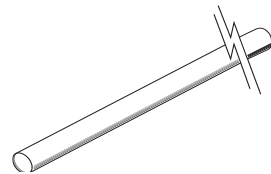

Swivel Wheels For Swing Gate / For Pipe • Pressed Steel – Galvanized Includes bolts

DESCRIPTION	PART NO.	PER SACK	WEIGHT EA.	NOTES
Fits 1-3/8" Frame	018361	4	4.62	
Fits 1-5/8" Frame	018362	4	4.71	
Fits 1-7/8" Frame	018363	4	4.83	
Fits 1-5/8" or 1-7/8" Frame	015420	4	4.50	

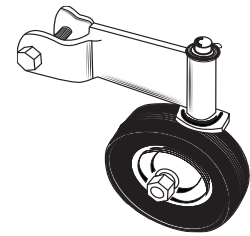

Rubber-Tired Steel Hub Wheels / Regular • Includes bolts

DESCRIPTION	PART NO.	PER SACK	WEIGHT EA.	NOTES
6" With 5/8" Bearing	017602	6	2.17	
8" With 5/8" Bearing	017604	6	3.50	

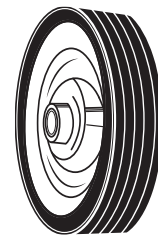

Rubber-Tired Steel Hub Wheels / Heavy Duty • With Grease Fitting Includes bolts

DESCRIPTION	PART NO.	PER SACK	WEIGHT EA.	NOTES
8" With 3/4" Bearing	017610	1	6.21	



Rubber-Tired Aluminum Hub Wheels / With Grease Fitting • Includes bolts

DESCRIPTION	PART NO.	PER SACK	WEIGHT EA.	NOTES
8" With 5/8" Bearing	017606	6	3.75	

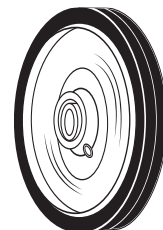

Rubber-Tired Pneumatic Steel Hub Wheels / • Includes bolts

DESCRIPTION	PART NO.	PER SACK	WEIGHT EA.	NOTES
8" With 5/8" Bearing	017615	1	2.90	



Single-Wheel Carriers / Pressed Steel – Galvanized • Includes bolts

Weld-on Type, 5/8" Axle.

DESCRIPTION	PART NO.	PER SACK	WEIGHT EA.	NOTES
1-5/8" Frame, 6" Wheel	018201	4	4.80	
1-5/8" Frame, 8" Wheel	018202	4	7.21	
1-7/8" Frame, 6" Wheel	018203	4	4.82	
1-7/8" Frame, 8" Wheel	018204	4	7.23	

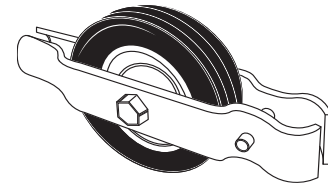

Residential Double-Wheel Carriers / Pressed Steel – Galvanized Includes bolts

Clamp-on Type 5/8" Axle, 7" Wheel Base. For 1-5/8" or 1-7/8" Frame.

DESCRIPTION	PART NO.	PER SACK	WEIGHT EA.	NOTES
6" Wheel	018331	4	6.25	
8" Wheel	018332	4	9.25	

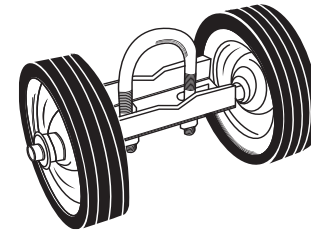

Industrial Double-Wheel Carriers / Pressed Steel – Galvanized • Includes bolts

Clamp-on Type 5/8" Axle, 12" Wheel Base. For 1-5/8" or 1-7/8" Frame.

DESCRIPTION	PART NO.	PER SACK	WEIGHT EA.	NOTES
6" Steel Hub Wheels	018301	4	8.50	
8" Steel Hub Wheels	018302	4	12.38	
8" Aluminum Hub Wheels with Grease Fitting	018304	4	10.80	
Carrier Only Without 6" Wheels	018306	4	5.34	
Carrier Only Without 8" Wheels	018307	4	5.66	

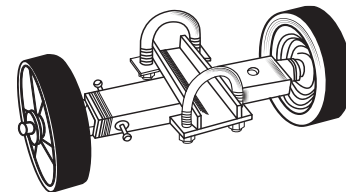

Heavy Duty Ground Carrier / Pressed Steel – Galvanized • Includes bolts

Clamp-on Type, Outrigger Fittings, 3/4" Axle, 21" Wheel Base. For 1-5/8" or 1-7/8" Frame.

DESCRIPTION	PART NO.	PER SACK	WEIGHT EA.	NOTES
8" Heavy Duty Steel Hub Wheels with Grease Fittings	018341	1	28.00.	

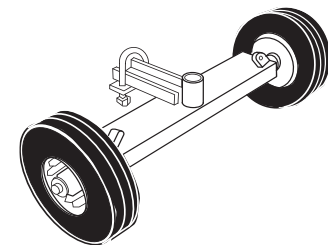

Rough N' Ready Carrier / Pressed Steel – Galvanized • Includes bolts

Clamp-on Type, 5/8" Axle, 12" Wheel Base. For 1-5/8" or 1-7/8" Frame.

DESCRIPTION	PART NO.	PER SACK	WEIGHT EA.	NOTES
8" Pneumatic Steel Hub Wheels	018344	1	28.00	

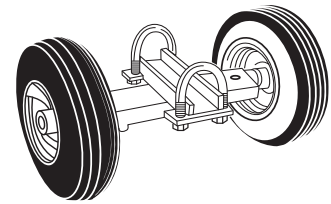

V-Groove Wheels / Malleable Iron • With Grease Fitting

With Bushing, without Axle.

DESCRIPTION	PART NO.	PER SACK	WEIGHT EA.	NOTES
4" Wheel	018371	4	5.00	
6" Wheel	018372	4	6.08	

Use 5/8" Axle (sold separately).

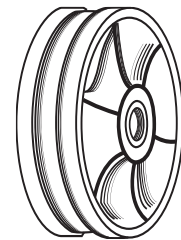

V-Groove, Single-Wheel Carrier / Pressed Steel – Galvanized • Includes bolts

Weld-on Type, 5/8" Axle.

DESCRIPTION	PART NO.	PER SACK	WEIGHT EA.	NOTES
1-5/8" Frame, 6" Wheel	018271	4	9.00	

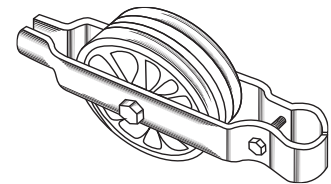

V-Groove, Double-Wheel Carrier / Pressed Steel – Galvanized • Includes bolts

Clamp-on Type 5/8" Axle, 12" Wheel Base.

DESCRIPTION	PART NO.	PER SACK	WEIGHT EA.	NOTES
1-5/8" or 1-7/8" Frame	018273	4	12.00	

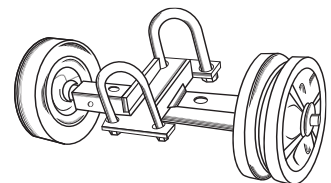

Safe-T Rear Wheel For 1-5/8" Pipe Track / Pressed Steel – Galvanized Includes bolts

DESCRIPTION	PART NO.	PER SACK	WEIGHT EA.	NOTES
5" Wheel	018421	10	2.90	
5" Wheel w/Bracket Assembly*	018422	4	4.55	
5" Wheel w/Bracket Assembly**	856V00	10	5.52	
7" Wheel	018418	10	2.90	
7" Wheel w/Bracket Assembly*	018419	4	4.55	
*Universal Holding Bracket Assembly for 1-5/8" or 1-7/8" Frame				
**Dual Bolt Bracket Assembly				
Universal Holding Bracket Only (With 6" Bolt)	018413	25	1.85	

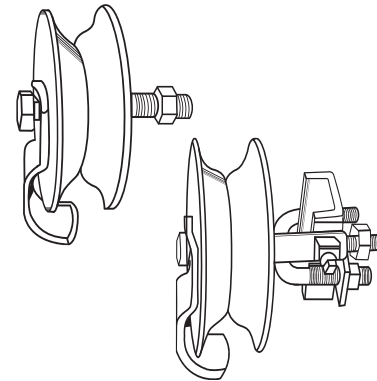

Safe-T Rear Wheel For 1-5/8" Pipe Track / Heavy Duty – Malleable Includes bolts with Grease Fitting

DESCRIPTION	PART NO.	PER SACK	WEIGHT EA.	NOTES
5" Wheel	018441	10	5.75	
5" Wheel w/Bracket Assembly*	018442	4	7.92	
*Universal Holding Bracket Assembly for 1-5/8" or 1-7/8" Frame				
Universal Holding Bracket Only (With 6" Bolt)	018413	25	1.85	

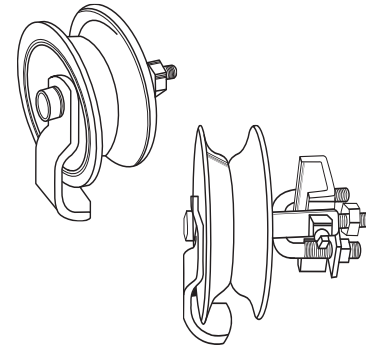

Clamp-On Roller Bracket / Heavy Duty • Pressed Steel – Galvanized Includes U-Bolt

DESCRIPTION	PART NO.	PER SACK	WEIGHT EA.	NOTES
1-5/8" or 1-7/8" Frame	018412	25	1.85	

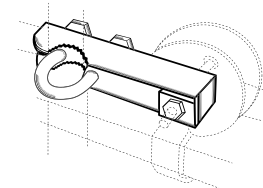

Brackets For Rear Wheel / Pressed Steel – Galvanized

DESCRIPTION	PART NO.	PER SACK	WEIGHT EA.	NOTES
1-5/8" Gate Frame	018410	25	0.66	
1-7/8" Gate Frame	018411	25	0.68	

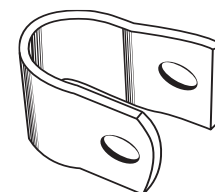

Safe-T Line Track Brackets 1-5/8" Pipe Track / Heavy Duty Pressed Steel – Galvanized • Includes bolts

DESCRIPTION	PART NO.	PER SACK	WEIGHT EA.	NOTES
For 1-5/8" or 1-7/8" Post	018561	20	2.55	
For 2-3/8" or 2-7/8" Post	018562	20	2.65	
For 4" Post	018631	20	2.92	

NOTE: Pat. No. 3,215,702

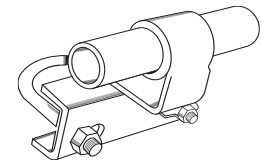

Safe-T End Track Brackets for 1-5/8" Pipe Track / Heavy Duty Pressed Steel – Galvanized • Includes bolts

DESCRIPTION	PART NO.	PER SACK	WEIGHT EA.	NOTES
For 1-5/8" or 1-7/8" Post	018565	20	3.16	
For 2-3/8" or 2-7/8" Post	018566	20	3.29	

NOTE: Pat. No. 3,215,702

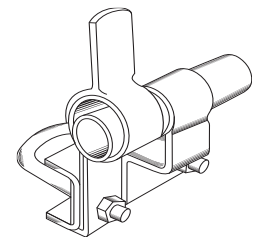

Safe-T Gate Stop for 1-5/8" Pipe Track / Pressed Steel – Galvanized

DESCRIPTION	PART NO.	PER SACK	WEIGHT EA.	NOTES
Heavy Duty	018569	20	0.71	

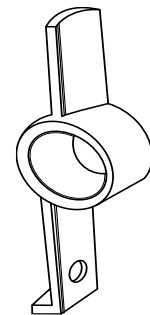

Flat-Back Line Track Bracket for 1-5/8" Pipe Track / Pressed Steel – Galvanized

DESCRIPTION	PART NO.	PER SACK	WEIGHT EA.	NOTES
Flat Back	018534	20	1.93	

NOTE: For Flat Surface-Block Walls.

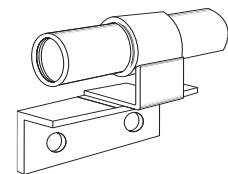

Band-Type Line Track Bracket for 1-5/8" Pipe Track / Pressed Steel – Galvanized

DESCRIPTION	PART NO.	PER SACK	WEIGHT EA.	NOTES
Universal	018538	20	1.38	

Use with two 1/8" x 1" Brace Bands (sold separately).

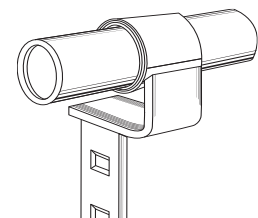

Safe-T Rolling Gate

Typical Residential Installation

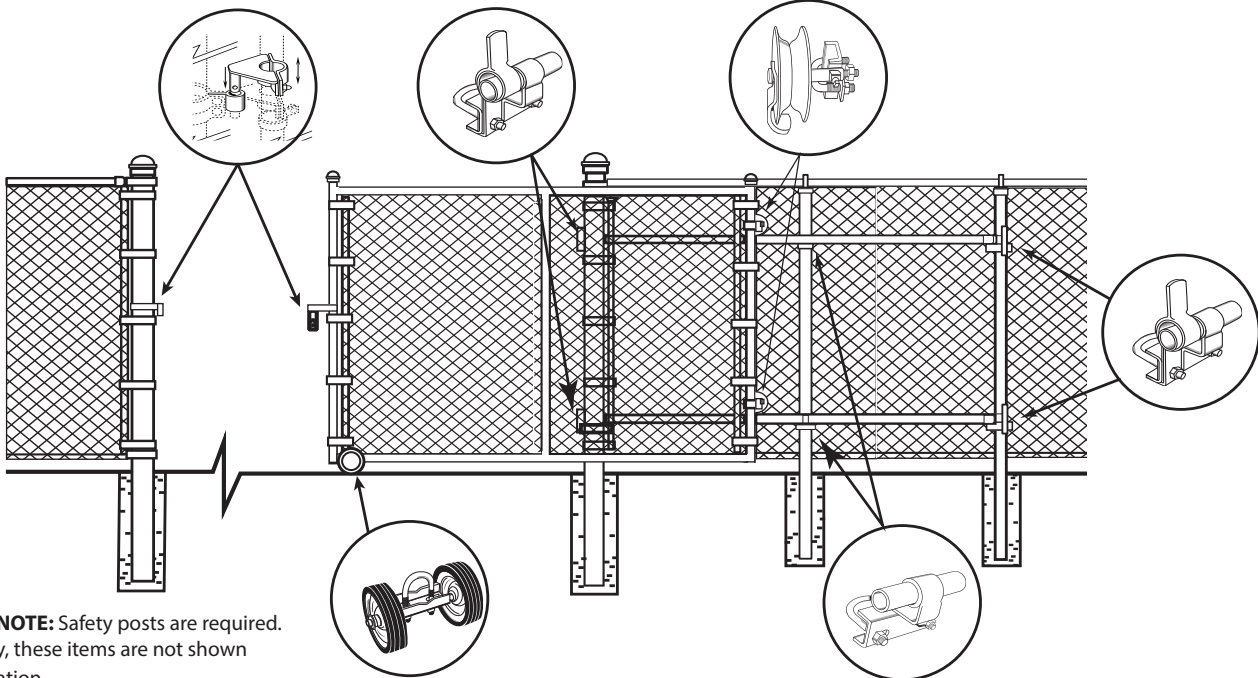

SAFETY NOTE: Safety posts are required. For clarity, these items are not shown on illustration.

Safe-T Rolling Gate-Residential

Optional Carriers

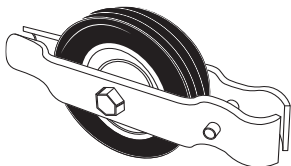

Single-Wheel Carrier

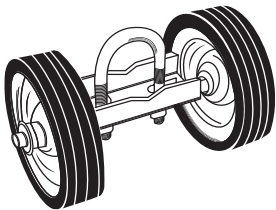

Residential Double-Wheel Carrier
7" wheel base

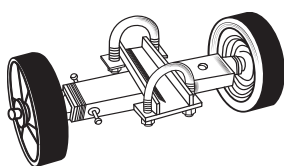

Industrial Double-Wheel Carrier
12" wheel base

Optional Rear Wheels

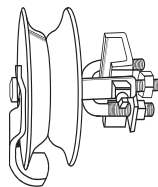

5" Pressed Steel
with Bracket
Assembly

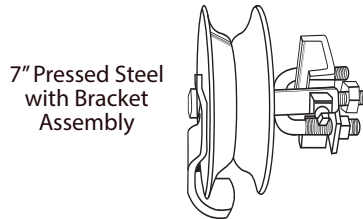

7" Pressed Steel
with Bracket
Assembly

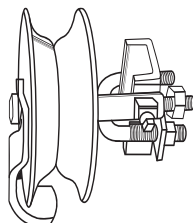

5" Malleable
with Bracket
Assembly

Optional Brackets

Line Bracket



Safe-T

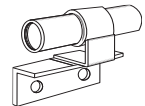

Flat Back

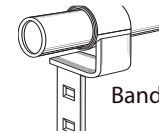

Band Type

End Bracket

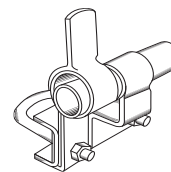

Safe-T

Safe-T Gate Stop

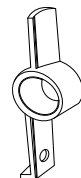

Heavy Duty

Safe-T Rolling Gate

Typical Industrial Installation With Barbed Wire

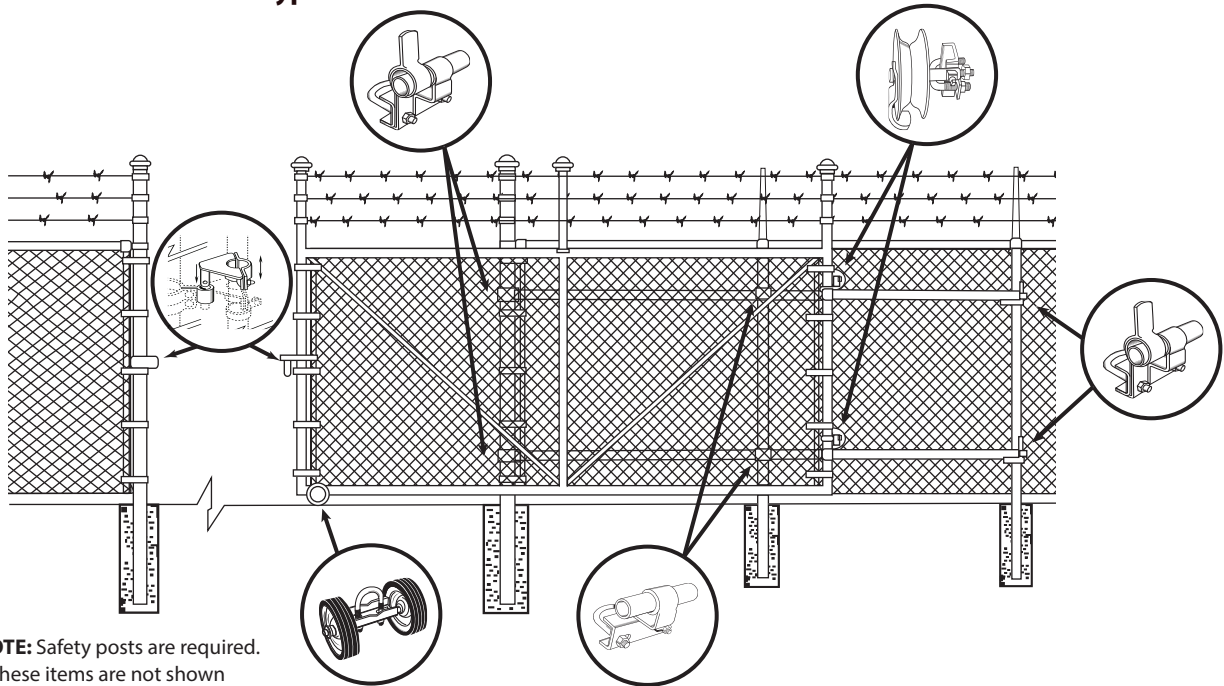

SAFETY NOTE: Safety posts are required. For clarity, these items are not shown on illustration.

Safe-T Rolling Gate-Industrial

Optional Carriers

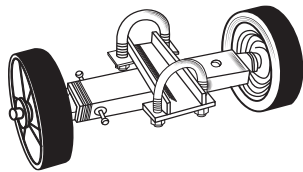

Industrial Double-Wheel Carrier
12" wheel base

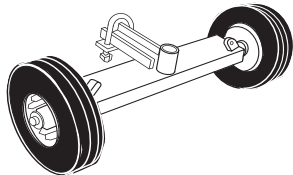

Heavy Duty Ground Carrier
21" wheel base

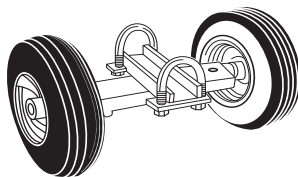

Rough N' Ready Carrier
12" wheel base

Optional Rear Wheels

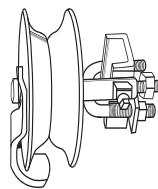

5" Pressed Steel
with Bracket
Assembly

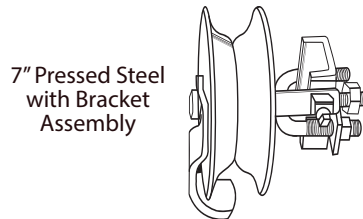

7" Pressed Steel
with Bracket
Assembly

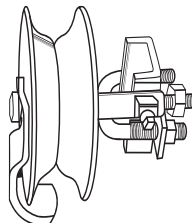

5" Malleable
with Bracket
Assembly

Optional Brackets

Band Type

Universal

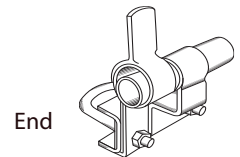

End



Line

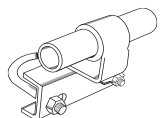

Optional Latches

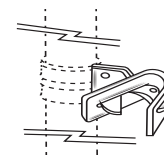

Offset
Lock N' Latch

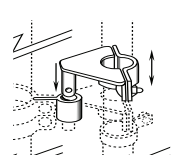

Rolo
Latch

Adaptrack Gate Conversion Kit

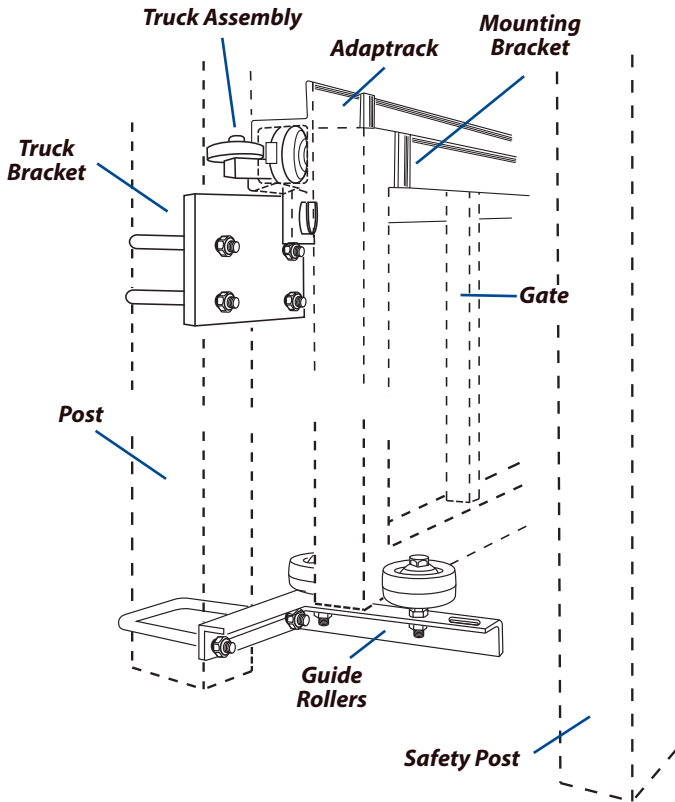

The adaptable conversion kit is a complete set of track, hardware and accessories designed to convert a standard gate into a smooth sliding cantilever gate. The track is a specially designed aluminum extrusion. The shape of the extrusion provides an enclosed chamber through which the truck assemblies roll. Brackets are included to mount the track to either round (2-3/8" O.D.) or square (2") horizontal top rails. The flat-back design of the track makes it possible to mount the track, without brackets, directly to the flat surface of a wood gate.

Adaptrack

NOTE: APPROXIMATELY 4" FROM FACE OF POST TO FACE OF GATE FRAME.

Adaptrack Gate Conversion Kit

PART NO. SQUARE	PART NO. ROUND	WEIGHT	GATE OPENING	CANTILEVER EXT. LENGTH	TRACK LENGTH SUPPLIED	NOTES
—	018427	104.0	10'	6'	16' 3"	
—	018428	112.0	12'	6'	18' 3"	
018390	—	120.0	14'	6'	20' 3"	
018391	018430	144.0	16'	10'	10' 3" (1) + 16' 3" (1)	
018392	018443	152.0	18'	10'	10' 3" (1) + 18' 3" (1)	
018393	018444	160.0	20'	10'	10' 3" (1) + 20' 3" (1)	
018394	018445	168.0	22'	10'	16' 3" (1) + 16' 3" (1)	
—	018446	176.0	24'	10'	16' 3" (1) + 18' 3" (1)	
—	018447	184.0	26'	10'	18' 3" (1) + 18' 3" (1)	
018426	018449	200.0	30'	10'	20' 3" (1) + 20' 3" (1)	

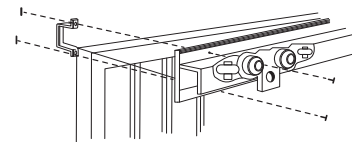

Square Frame Kit

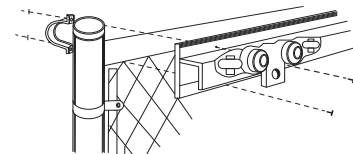

Round Frame Kit

Adaptrack

DESCRIPTION	PART NO.	WEIGHT EA.	NOTES
10' 3"	018501	40.00	
16' 3"	018502	64.00	
18' 3"	018503	72.00	
20' 3"	018504	80.00	

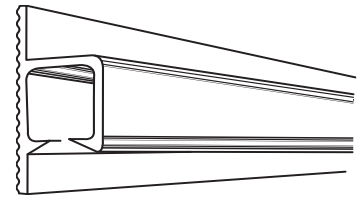

Adaptrack Mounting Brackets

DESCRIPTION	PART NO.	WEIGHT EA.	NOTES
2" Square	018505	0.50	
2-3/8" Round	018506	0.50	

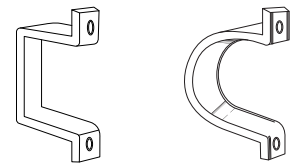

Trolley Assembly / For 6" I-Beam

DESCRIPTION	PART NO.	PER SACK	WEIGHT EA.	NOTES
Single Trolley	017675	4	9.00	
Double Trolley	017677	2	18.00	

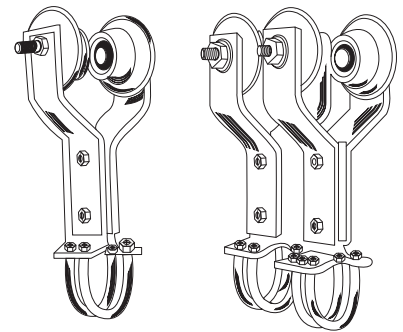

Overhead Rolling Gate

Typical Industrial Installation

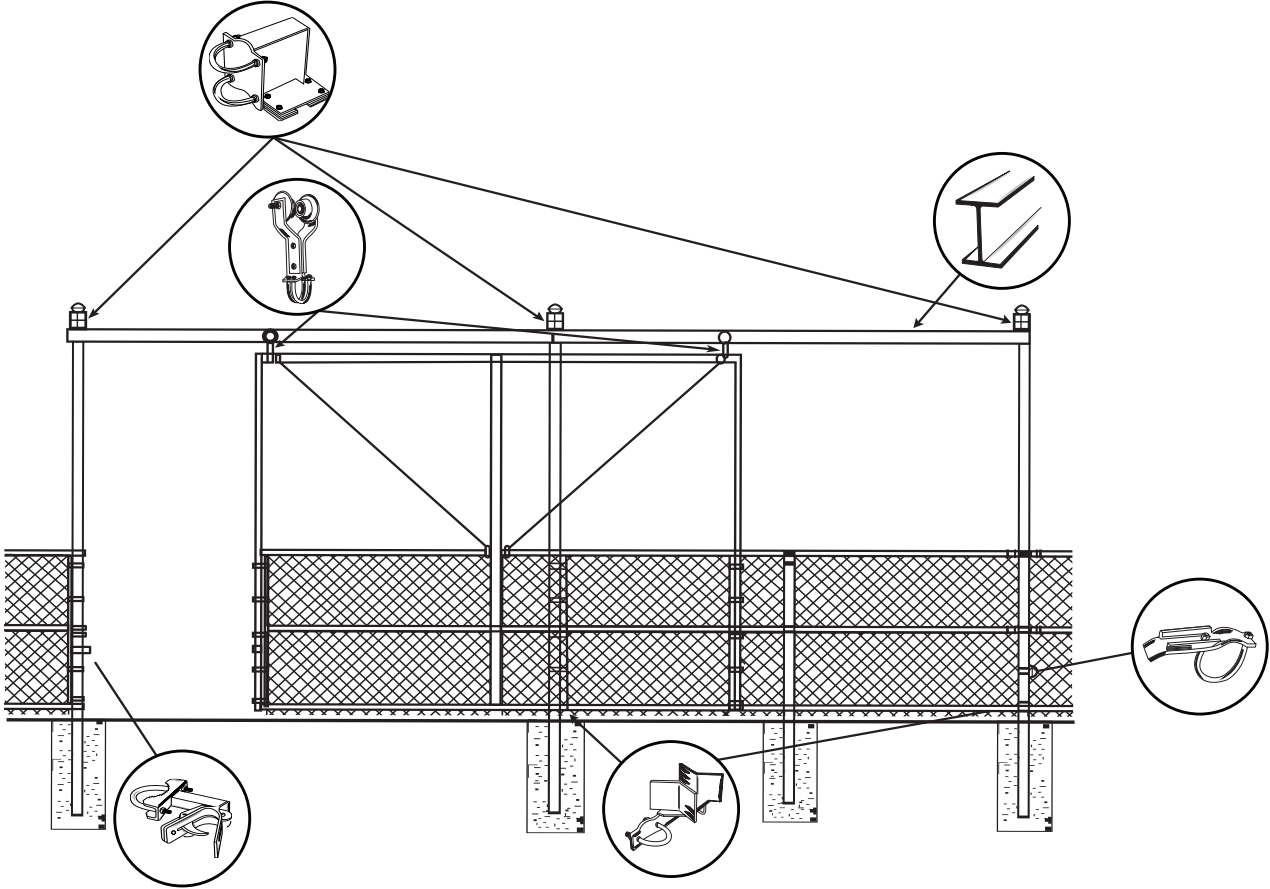

SAFETY NOTE: Safety posts are required. For clarity, these items are not shown on illustration.

Optional Trollies



Single

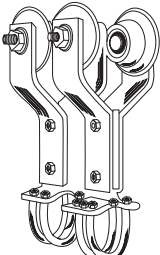

Double

Optional Hangers

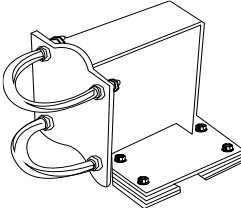

Single Post

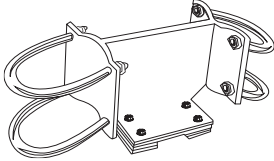

Double Post

Cantilever Gate Roller Assembly / Light Industrial – Aluminum

For use on 14' opening or less

NOTE: Includes bolts.

DESCRIPTION	PART NO.	PER SACK	WEIGHT EA.	NOTES
2-3/8" (post) x 1-5/8" (roller)	018374	4	2.82	

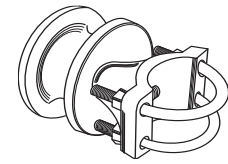

Cantilever Gate Roller Assembly / Malleable Iron – Galvanized

Must use cover.

NOTE: Includes bolts.

DESCRIPTION	PART NO.	PER SACK	WEIGHT EA.	NOTES
2-7/8" (post) x 2-3/8" (roller)	018382	4	15.80	
4" (post) x 2-3/8" (roller)	018384	4	16.50	
6-5/8" (post) x 2-3/8" (roller)	018385	4	26.00	
8-5/8" (post) x 2-3/8" (roller)	006908	4	19.00	

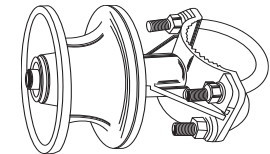

Load Master Cantilever Gate Roller / Heavy Industrial • Malleable Iron – Galvanized

NOTE: Includes bolts.

DESCRIPTION	PART NO.	PER SACK	WEIGHT EA.	NOTES
4" (post) x 2-3/8" (roller)	018387	4	16.00	

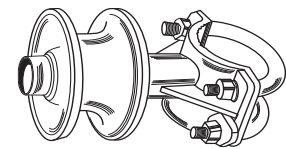

Load Master™

(Loadmaster exploded)

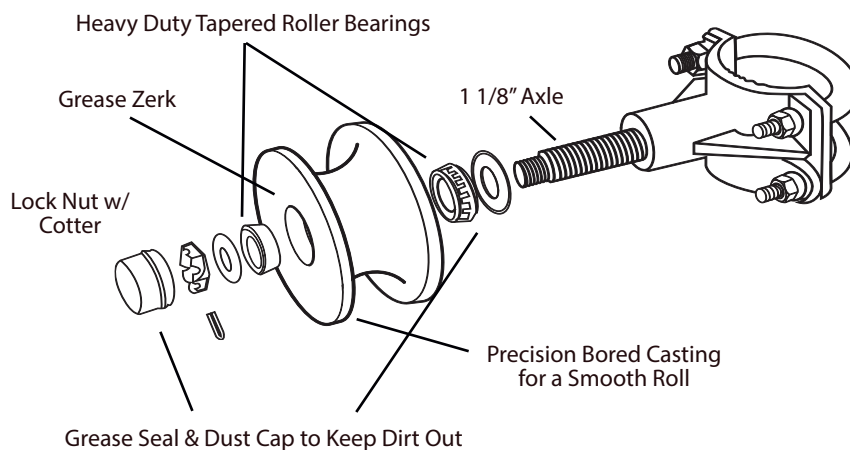

Features

- Heavy Duty Tapered Roller Bearings
- Ideal for Heavy Gates
- Handles the Swaying Action of the Gate as it Travels
- Malleable Iron Construction

SAFETY NOTE: All cantilever rollers require roller covers or guards.

Load Master™ II Nylon Cantilever Roller

(Loadmaster exploded)

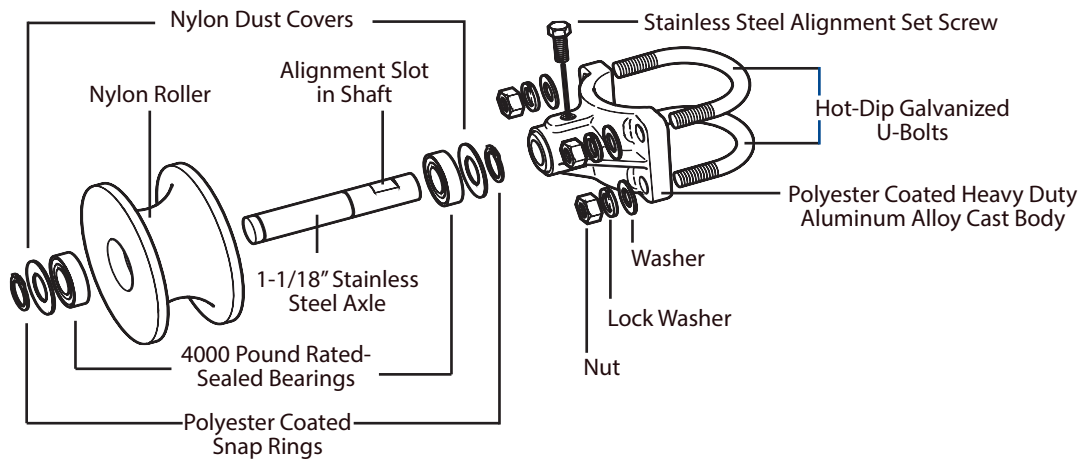

- 4000 Pound rating operates the heaviest of gates
- Sealed bearings provide maintenance-free operation
- Strong aluminum alloy cast body for durability
- Easy rolling for manual and electrically operated gates
- UV impregnated nylon/fiberglass wheel for discoloration protection

- 1-1/8" Stainless steel shaft for added strength and corrosion protection
- Slot in axle and set screw allows wheel to move in and out of body for perfect alignment
- Nylon dust covers to prevent damage to the bearing on each end of the shaft
- Polyester coated body to eliminate oxidation
- Polyester coated snap rings to prevent rust

Load Master™ II Nylon Cantilever Gate Rollers / Heavy Industrial Aluminum Alloy Cast Body

NOTE: Includes bolts.

DESCRIPTION	PART NO.	PER SACK	WEIGHT EA.	NOTES
2-7/8" Post x 2-3/8" Roller	194K00	4	10.10	
4" Post x 2-3/8" Roller with Cover	018349	2	11.29	
4" Post x 2-3/8" Roller	018369	4	10.10	
6-5/8" Post x 2-3/8" Roller with Cover	018351	2	11.29	
6-5/8" Post x 2-3/8" Roller	018350	4	13.20	
Covers (fits all sizes)	018348	4	1.19	
Stop/Guard Covers (fits all sizes)	018355	4	1.19	

SAFETY NOTE: All cantilever rollers require roller covers or guards.

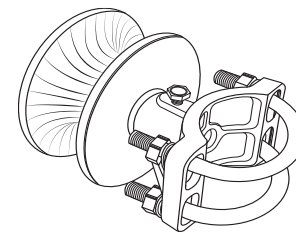

5-Year Limited Warranty

Cantilever Rolling Gate Typical Industrial Installation with Barbed Wire

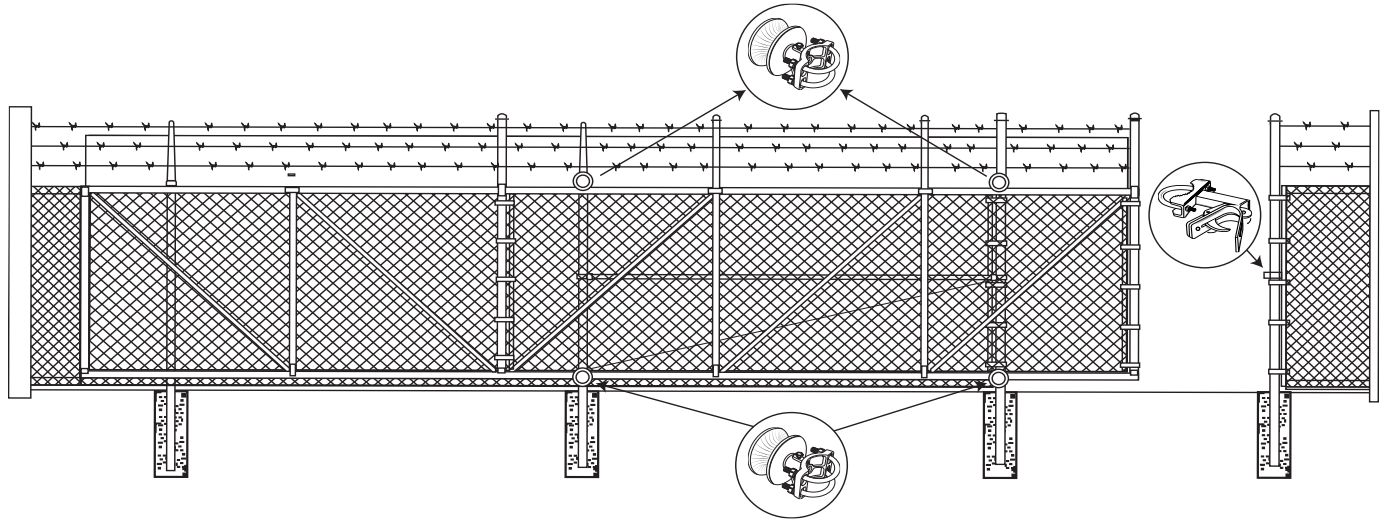

SAFETY NOTE: Safety posts and roller covers/guards are required. For clarity, these items are not shown in illustration

Cantilever Latch

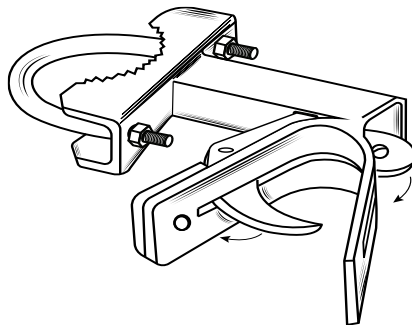

**Load Master™ II
Cantilever Gate Roller**

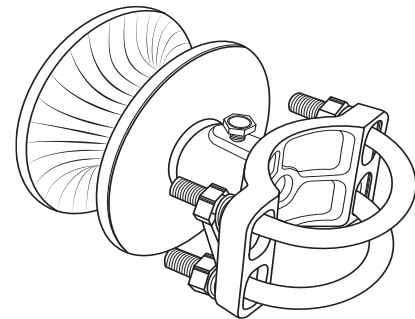

Roll-R Cover / For Cantilever Rollers

- Fits 2-7/8" or 4" post and 2-3/8" roller.
- For top rollers only.
- Requires 2-1/2" cut-out when used with Load Master rollers

DESCRIPTION	PART NO.	PER CASE	WEIGHT EA.	NOTES
Roll-R Cover Pressed Steel	018383	2	4.10	
Roll-R Cover "Protector"	018380	2	2.50	

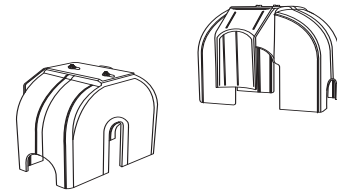

Roll-R Guard / For Cantilever Rollers • Pressed Steel – Galvanized

- Fits 2-7/8" or 4" post and 2-3/8" roller.
- Can be used on top and bottom rollers.
- Nonmetallic shields for quieter operation.
- Easy installation.
- No drilling required.
- Includes nuts

DESCRIPTION	PART NO.	PER CASE	WEIGHT EA.	NOTES
Roll-R Guard	018381	4	5.00	

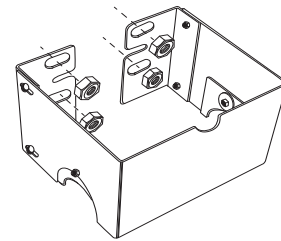

Roll-R Guard

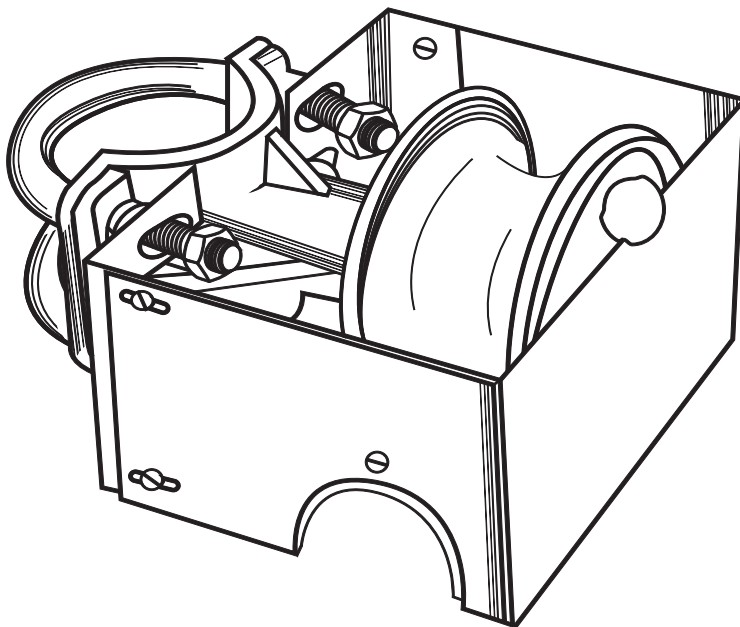

Features

- Heavy Duty
- Pressed Steel
- Hot Dip Galvanized
- Easy Installation

SAFETY NOTE: All cantilever rollers require roller covers or guards.

Gate Frame Hinge - Domestic / Regular • Pressed Steel – Galvanized

DESCRIPTION	PART NO.	PER SACK	WEIGHT EA.	NOTES
1-3/8" x 5/8"	14104D	100	.31	

Use 3/8" x 2" Carriage Bolt – Pt. #010706

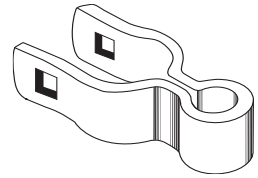

Gate Frame Hinge - Domestic / Heavy Duty • Pressed Steel – Galvanized

DESCRIPTION	PART NO.	PER SACK	WEIGHT EA.	NOTES
1-5/8" x 5/8"	14105D	50	.52	

Use 3/8" x 2-1/4" Carriage Bolt – Pt. #010707

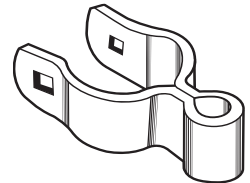

Post Hinge - Domestic / Heavy Duty • Pressed Steel – Galvanized

DESCRIPTION	PART NO.	PER SACK	WEIGHT EA.	NOTES
2-7/8" x 5/8"	014310	50	1.11	

Use 3/8" x 3-1/2" Carriage Bolt – Pt. #010712

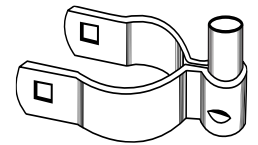

180° Industrial Hinges - Domestic / Pressed Steel – Galvanized

DESCRIPTION	PART NO.	PER SACK	WEIGHT EA.	NOTES
2-3/8" x 1-5/8" or 1-7/8"	15601D	10	3.00	
2-7/8" x 1-5/8" or 1-7/8"	05603D	10	3.20	
4" x 1-5/8" or 1-7/8"	15605D	10	4.20	
6-5/8" x 1-5/8" or 1-7/8"	15607D	4	6.00	

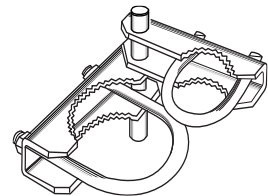

Bulldog Industrial Hinges - Domestic / Pressed Steel – Galvanized

DESCRIPTION	PART NO.	PER SACK	WEIGHT EA.	NOTES
2-3/8" x 1-5/8" or 1-7/8"	15671D	10	3.20	
2-7/8" x 1-5/8" or 1-7/8"	15672D	10	3.30	
4" x 1-5/8" or 1-7/8"	15674D	10	3.70	
6-5/8" x 1-5/8" or 1-7/8"	15676D	4	5.90	

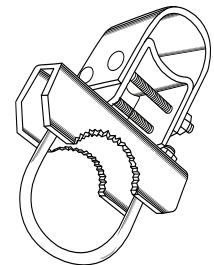

Steel Gate Hinges - Domestic / Pressed Steel - Galvanized

DESCRIPTION	PART NO.	PER SACK	WEIGHT EA.	NOTES
2-7/8" x 1-5/8"	15624D	10	3.70	
2-7/8" x 1-7/8"	15625D	10	4.00	
4" x 1-5/8"	15628D	10	4.50	
4" x 1-7/8"	15629D	10	4.50	

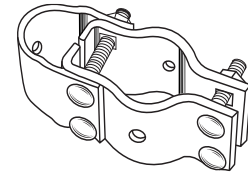

180° Offset Adapter - Domestic / Malleable Iron - Galvanized Includes U-Bolts

DESCRIPTION	PART NO.	PER SACK	WEIGHT EA.	NOTES
1-7/8" Gate Frame	005440	10	5.00	

NOTE: Use with 1-7/8" Nosepiece on Industrial Box, Bulldog, and Steel Gate Hinges.

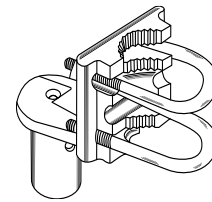

Fork Latch Assembly - Domestic / Heavy Duty - Pressed Steel - Galvanized Includes bolts

DESCRIPTION	PART NO.	PER SACK	WEIGHT EA.	NOTES
1-5/8" x 2-7/8"	16758D	25	1.14	
1-7/8" x 4"	007576	25	1.27	

NOTE: This item is assembled.

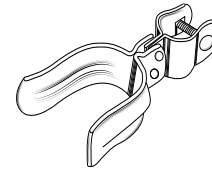

Fork Latch Assembly - Domestic / Malleable Iron - Galvanized

NOTE: This item is assembled, includes bolts.

DESCRIPTION	PART NO.	PER SACK	WEIGHT EA.	NOTES
1-5/8" x 2-7/8"	16606D	25	1.61	
1-7/8" x 2-7/8"	16608D	20	1.65	

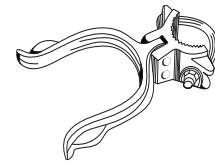

Fork Latch Hangers (Collars) - Domestic / Regular • Pressed Steel – Galvanized

DESCRIPTION	PART NO.	PER SACK	WEIGHT EA.	NOTES
1-5/8"	16732D	100	0.50	
1-7/8"	16733D	100	0.56	

Use 5/16" x 1-1/4" Carriage Bolt – Pt. #010701

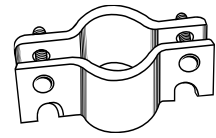

Fork - Domestic / Heavy Duty • Pressed Steel – Galvanized

DESCRIPTION	PART NO.	PER SACK	WEIGHT EA.	NOTES
2-7/8"	16725D	50	0.52	

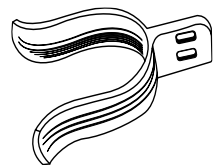

Industrial Latches - Domestic / Pressed Steel – Galvanized

NOTE: Optional with 4 Guides and 2 Forks at extra cost.

DESCRIPTION	PART NO.	PER SACK	WEIGHT EA.	NOTES
1-7/8" Assembly	17202D	10	4.98	
Assembly includes: 1 Fork, 3 Guides, Bolts. Drop Rod not included.				
1-5/8" Guide Only	17211D	75	0.99	
Use 3/8" x 2-1/4" Carriage Bolt – Pt. #010707				
1-7/8" Guide Only	17212D	75	1.05	
Use 3/8" x 2-1/2" Carriage Bolt – Pt. #010708				
1-5/8" Fork Only	17213D	25	1.54	
1-7/8" Fork Only	17214D	25	1.56	
1-7/8" Assembly with Drop Rod	17218D	10	12.00	

Assembly with Drop Rod includes: Fork, 3 Guides, Bolts, 1-3/8" x 7' Drop Rod – w/ Fork welded to Rod.

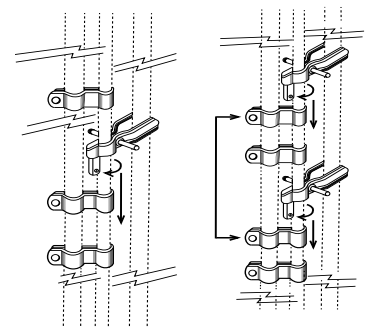

V-Groove Wheels - Domestic / Steel • With Grease Fitting

With Bushing, without Axle

NOTE: Use 5/8" Axle (sold separately).

DESCRIPTION	PART NO.	PER SACK	WEIGHT EA.	NOTES
4" Wheel	400100	4	5.20	
6" Wheel	401100	4	12.76	

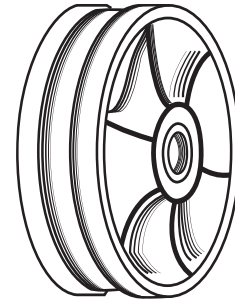

Safe-T Rear Wheel For 1-5/8" Pipe Track - Domestic / Pressed Steel - Galvanized • Includes bolts

DESCRIPTION	PART NO.	PER SACK	WEIGHT EA.	NOTES
5" Wheel w/Bracket Assembly*	18422D	4	4.25	

*Universal Holding Bracket Assembly for 1-5/8" or 1-7/8" Frame

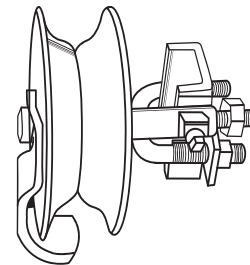

Cantilever Gate Roller Assembly - Domestic / Malleable Iron - Galvanized Includes bolts

DESCRIPTION	PART NO.	PER SACK	WEIGHT EA.	NOTES
2-7/8" (post) x 2-3/8" (roller)	018396	4	18.00	
4" (post) x 2-3/8" (roller)	018397	4	18.00	
6-5/8" (post) x 2-3/8" (roller)	018398	4	18.00	

NOTE: Must use cover.

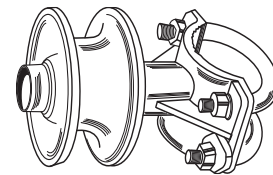

Frame Hinges / Regular • Pressed Steel – Galvanized • Polyester

DESCRIPTION	PART NO.	BOX QTY.	WEIGHT EA.	NOTES
1-3/8" x 5/8"	60863_	50	0.50	
1-5/8" x 5/8"	60881_	25	0.60	

Use 3/8" x 2" Carriage Bolt – Pt. #010706

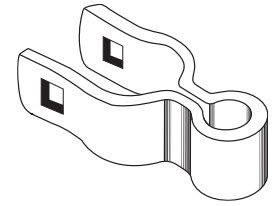

Frame Hinge / Heavy Duty • Pressed Steel – Galvanized • Polyester

DESCRIPTION	PART NO.	PER SACK	WEIGHT EA.	NOTES
1-3/8" x 5/8"	63457_	100	.38	

Use 3/8" x 2-1/4" Carriage Bolt – Pt. #010707

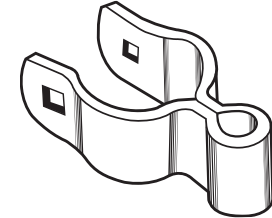

Post Hinges / Regular • Pressed Steel – Galvanized • Polyester

DESCRIPTION	PART NO.	PER SACK	WEIGHT EA.	NOTES
1-7/8" x 5/8"	60897_	25	0.62	

Use 3/8" x 2-1/4" Carriage Bolt – Pt. #010707

2-3/8" x 5/8"	60898_	25	0.68	
---------------	--------	----	------	--

Use 3/8" x 3" Carriage Bolt – Pt. #010710

2-7/8" x 5/8"	60939_	25	1.11	
---------------	--------	----	------	--

Use 3/8" x 3-1/2" Carriage Bolt – Pt. #010712

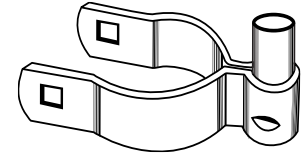

Post Hinges / Heavy Duty • Pressed Steel – Galvanized • Polyester

DESCRIPTION	PART NO.	PER SACK	WEIGHT EA.	NOTES
1-7/8" x 5/8"	63460_	25	.62	

Use 3/8" x 2-1/4" Carriage Bolt – Pt. #010707

2-3/8" x 5/8"	63459_	25	.62	
---------------	--------	----	-----	--

Use 3/8" x 3" Carriage Bolt – Pt. #010710

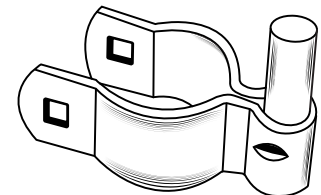

TruClose Hinge by D&D / Black Polymer • Includes fasteners

DESCRIPTION	PART NO.	PER SACK	WEIGHT PR.	NOTES
2-3/8 to 2-7/8 x 1-5/8 to 1-7/8 TCHDRND1-MK2	198012	10	2.20	

NOTE: Requires 1" spacing between Gate Post and Gate Frame.

Add the following number to the part no. for desired color:

1-Forest Green 2-Midnight Black 3-Sierra Brown

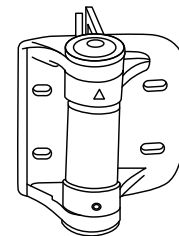

Single Swing Gate Hardware Sets / Pressed Steel - Galvanized • Polyester

DESCRIPTION	PART NO.	BOX QTY.	WEIGHT EA.	NOTES
2-3/8" x 1-3/8"	68195_	6	2.85	

Includes 2 Frame Hinges, 2 Post Hinges, 1 Fork Latch Assembly, Bolts.

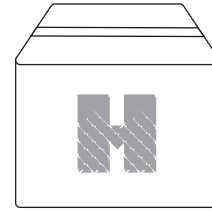

Double Swing Gate Hardware Sets / Pressed Steel - Galvanized • Polyester

DESCRIPTION	PART NO.	BOX QTY.	WEIGHT EA.	NOTES
2-3/8" x 1-3/8"	68196_	6	4.00	

Includes 4 Frame Hinges, 4 Post Hinges, Bolts. Without Latch.

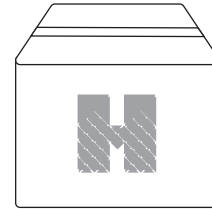

180° Industrial Hinges / Pressed Steel - Galvanized • Polyester

DESCRIPTION	PART NO.	PER SACK	WEIGHT EA.	NOTES
2-3/8" x 1-5/8" or 1-7/8"	61091_	4	3.20	
2-7/8" x 1-5/8" or 1-7/8"	61092_	4	3.20	
4" x 1-5/8" or 1-7/8"	60020_	4	4.20	
6-5/8" x 1-5/8" or 1-7/8"	60021_	4	6.00	

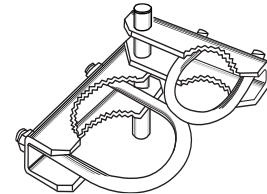

Bulldog Industrial Hinges / Pressed Steel - Galvanized • Polyester

DESCRIPTION	PART NO.	PER SACK	WEIGHT EA.	NOTES
2-3/8" x 1-5/8" or 1-7/8"	60023_	10	3.20	
2-7/8" x 1-5/8" or 1-7/8"	61066_	10	3.30	
4" x 1-5/8" or 1-7/8"	61070_	10	3.70	
6-5/8" x 1-5/8" or 1-7/8"	61073_	10	5.90	

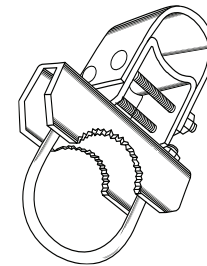

Magna Latches by D&D / Black Polymer

DESCRIPTION	PART NO.	PER SACK	WEIGHT EA.	NOTES
Top Pull - S3	009449	10	1.71	
Vertical Pull - S3	009450	10	1.38	
Round Post Adapter - S3	814X00	10	0.40	

NOTE: The Round Post Adapter fits a 1-3/8" to 1-5/8" frame and a 1-7/8" to 2-7/8" post.

Top Pull



Vertical Pull

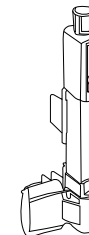

Round Post Adapter

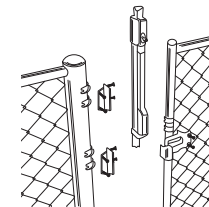

Add the following number to the part no. for desired color:
1-Forest Green 2-Midnight Black 3-Sierra Brown

Fork Latch Assembly / Regular • Pressed Steel - Galvanized • Polyester

Includes bolts

DESCRIPTION	PART NO.	PER SACK	WEIGHT EA.	NOTES
1-3/8" x 1-7/8"	61134_	10	0.96	
1-3/8" x 2-3/8"	63494_	10	1.02	
1-3/8" x 2-7/8"	63495_	10	1.08	
1-5/8" x 1-7/8"	61136_	10	1.10	
1-5/8" x 2-7/8"	61156_	10	1.11	
1-7/8" x 2-7/8"	61159_	10	1.72	

NOTE: This item is assembled.

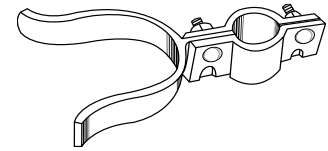

Fork Latch Assembly / Heavy Duty • Pressed Steel - Galvanized • Polyester

Includes bolts

DESCRIPTION	PART NO.	PER SACK	WEIGHT EA.	NOTES
1-3/8" x 2-3/8"	61135_	10	0.94	
1-5/8" x 2-3/8"	61139_	10	1.08	
1-5/8" x 2-7/8"	61140_	10	1.25	
1-5/8" x 4"	61141_	10	1.40	

NOTE: This item is assembled.

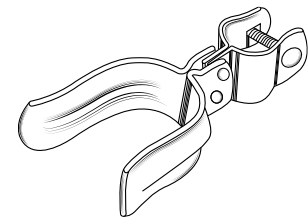

Fork Latch Hangers (Collars) / Pressed Steel - Galvanized • Polyester

DESCRIPTION	PART NO.	BOX QTY.	WEIGHT EA.	NOTES
1-3/8"	60029_	50	.43	
1-5/8"	60025_	25	.50	

Use 5/16" x 1-1/4" Carriage Bolt - Pt. #010701 or Pt. #62201_ (Spectra)

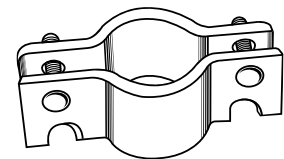

Forks / Heavy Duty • Pressed Steel - Galvanized • Polyester

DESCRIPTION	PART NO.	BOX QTY.	WEIGHT EA.	NOTES
2-3/8"	61118_	25	.50	
2-7/8"	60022_	25	.55	

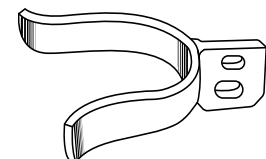

Add the following number to the part no. for desired color:

1-Forest Green 2-Midnight Black 3-Sierra Brown

Butterfly Latches / Pressed Steel Ear - Aluminum Back • Polyester • Includes bolts

DESCRIPTION	PART NO.	BOX QTY.	WEIGHT EA.	NOTES
1-3/8" x 2-3/8"	61212_	10	1.30	

NOTE: This item is assembled.

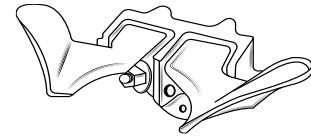

E-Z Latches / Galvanized Steel Rod and Guides • Polyester

DESCRIPTION	PART NO.	BOX QTY.	WEIGHT EA.	NOTES
1-3/8" x 42" Assembly	61277_	10	3.60	
Assembly includes: 1 Rod, 2 Guides, Bolts				
36" Rod Only	61145_	10	2.12	
42" Rod Only	61281_	10	1.40	
Guide Only with U-Bolt	61280_	20	0.43	

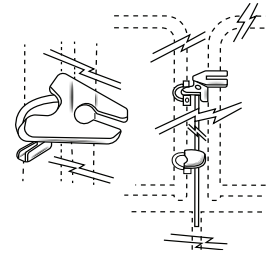

Industrial Latches for Drop Rod / Pressed Steel - Galvanized • Polyester

DESCRIPTION	PART NO.	BOX QTY.	WEIGHT EA.	NOTES
1-5/8"	61311_	1	4.80	
1-7/8"	61312_	1	5.20	

Assembly includes 1 Fork, 3 Guides, and Bolts. Drop rod not included

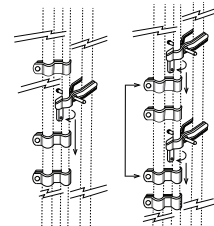

Optional 4+2

Strong Arm Latches / Galvanized Steel • Polyester • Black

DESCRIPTION	PART NO.	PER CTN.	WEIGHT EA.	NOTES
2-3/8" Post	017326	12	5.50	
2-7/8" Post	017327	12	5.50	
4" Post	017328	12	5.50	
For single swing gates - 1-5/8" or 1-7/8" Gate Frame.				
1-5/8" to 1-7/8" Frame	017325	12	9.00	
For double swing gates.				

Single Swing Gate

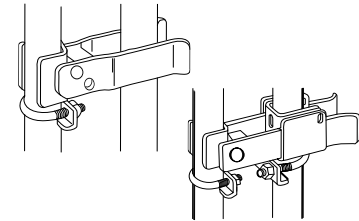

Double Swing Gate

Add the following number to the part no. for desired color:
1-Forest Green 2-Midnight Black 3-Sierra Brown

Cantilever Latches / Pressed Steel - Galvanized • Polyester • Includes bolts

DESCRIPTION	PART NO.	BOX QTY.	WEIGHT EA.	NOTES
2-7/8" Post	48154_	4	5.00	
4" Post	48155_	4	5.00	

NOTE: For 1-5/8" or 1-7/8" Gate Frame. Approximately 4-1/2" from face of post to center of gate frame.

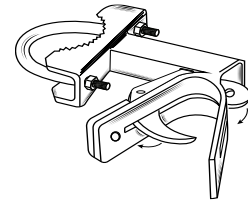

Gate Keeper / Pressed Steel - Galvanized • Polyester • Includes bolts

DESCRIPTION	PART NO.	BOX QTY.	WEIGHT EA.	NOTES
1-5/8"	48151_	10	1.00	

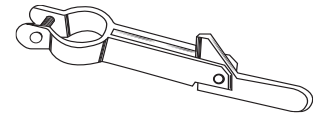

Gate Scrolls / One Piece Aluminum • Polyester

DESCRIPTION	PART NO.	BOX QTY.	WEIGHT EA.	NOTES
18"	61371_	10	.27	
24"	61372_	10	.33	



Gate Scrolls / Three-Piece Pressed Steel - Galvanized • Polyester

DESCRIPTION	PART NO.	PER SACK	WEIGHT EA.	NOTES
18"	61373_	10	1.12	



Gate Clips / Polyester

DESCRIPTION	PART NO.	BOX QTY.	WEIGHT EA.	NOTES
1-3/8" x 5/8"	61665_	250	.13	

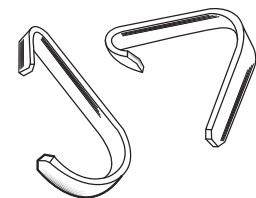

Add the following number to the part no. for desired color:
1-Forest Green 2-Midnight Black 3-Sierra Brown

Industrial Double-Wheel Carriers / Pressed Steel - Galvanized • Polyester Includes bolts

Clamp On Style, 5/8" Axle, 12" Wheel Base. For 1-5/8" or 1-7/8" Frame.

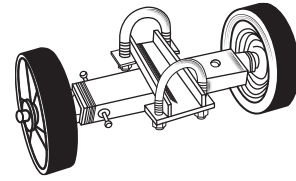

DESCRIPTION	PART NO.	BOX QTY.	WEIGHT EA.	NOTES
6" Steel Hub Wheels	61718_	1	9.00	
8" Steel Hub Wheels	61722_	1	12.00	

Safe-T Rear Wheel For 1-5/8" Pipe Track / Pressed Steel - Galvanized Polyester • Includes bolt

DESCRIPTION	PART NO.	BOX QTY.	WEIGHT EA.	NOTES
5" Wheel	61730_	10	2.90	
5" Wheel w/Bracket Assembly*	48204_	4	4.55	

*Universal Holding Bracket Assembly for 1-5/8" or 1-7/8" Frame

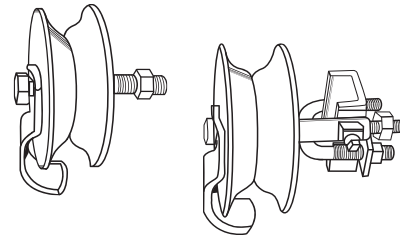

Brackets For Rear Wheel / Pressed Steel - Galvanized • Polyester

DESCRIPTION	PART NO.	BOX QTY.	WEIGHT EA.	NOTES
1-5/8" Gate Frame	61734_	10	.71	
1-7/8" Gate Frame	61735_	10	.83	

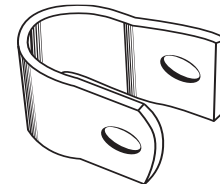

Safe-T Line Track Brackets for 1-5/8" Pipe Track / Heavy Duty • Pressed Steel - Galvanized • Polyester • Includes bolts

DESCRIPTION	PART NO.	PER SACK	WEIGHT EA.	NOTES
For 1-5/8" or 1-7/8" Post	61737_	20	2.55	
For 2-3/8" or 2-7/8" Post	61739_	20	2.65	

NOTE: Pat. No. 3,215,702

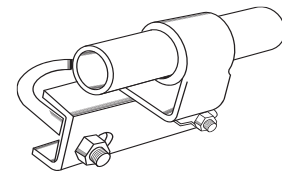

Add the following number to the part no. for desired color:
1-Forest Green 2-Midnight Black 3-Sierra Brown

Frame Hinge / Regular • Pressed Steel – Galvanized • Heavy Mil

DESCRIPTION	PART NO.	BOX QTY.	WEIGHT EA.	NOTES
1-3/8" x 5/8"	48053_	50	.38	

Use 3/8" x 2" Carriage Bolt – Pt. #010706

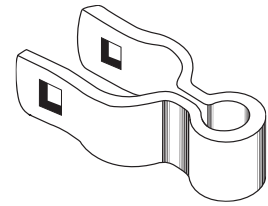

Frame Hinges / Heavy Duty • Pressed Steel – Galvanized • Heavy Mil

DESCRIPTION	PART NO.	PER SACK	WEIGHT EA.	NOTES
1-5/8" x 5/8"	48030_	25	.60	
1-7/8" x 5/8"	48032_	25	.68	

Use 3/8" x 2-1/4" Carriage Bolt – Pt. #010707

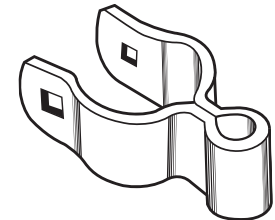

Post Hinges / Regular • Pressed Steel – Galvanized • Heavy Mil

DESCRIPTION	PART NO.	PER SACK	WEIGHT EA.	NOTES
1-5/8" x 5/8"	48218_	25	.52	
1-7/8" x 5/8"	48141_	25	.62	

Use 3/8" x 2-1/4" Carriage Bolt – Pt. #010707

2-3/8" x 5/8"	48142_	25	.68	
---------------	--------	----	-----	--

Use 3/8" x 3" Carriage Bolt – Pt. #010710

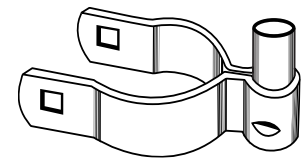

Post Hinges / Heavy Duty • Pressed Steel – Galvanized • Heavy Mil

DESCRIPTION	PART NO.	PER SACK	WEIGHT EA.	NOTES
2-7/8" x 5/8"	48143_	25	1.17	

Use 3/8" x 3-1/2" Carriage Bolt – Pt. #010712

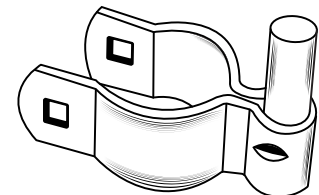

TruClose Hinge by D&D / Black Polymer • Includes fasteners

DESCRIPTION	PART NO.	PER SACK	WEIGHT PR.	NOTES
2-3/8 to 2-7/8 x 1-5/8 to 1-7/8 TCHDRND1-MK2	198012	10	2.20	

NOTE: Requires 1" spacing between Gate Post and Gate Frame.

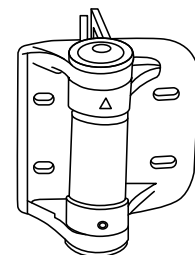

Add the following number to the part no. for desired color:

1-Forest Green 2-Midnight Black 3-Sierra Brown

Chain Link - Heavy Mil Gate Fittings



180° Industrial Hinges / Pressed Steel – Galvanized • Heavy Mil

DESCRIPTION	PART NO.	PER SACK	WEIGHT EA.	NOTES
2-3/8" x 1-5/8" or 1-7/8"	48037_	4	3.20	
2-7/8" x 1-5/8" or 1-7/8"	48038_	4	3.20	
4" x 1-5/8" or 1-7/8"	48039_	4	4.20	
6-5/8" x 1-5/8" or 1-7/8"	48040_	4	6.00	

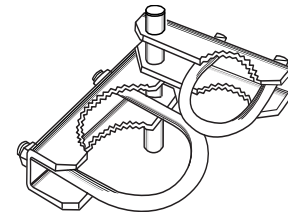

Bulldog Industrial Hinges / Pressed Steel – Galvanized • Heavy Mil

DESCRIPTION	PART NO.	PKG QTY.	WEIGHT EA.	NOTES
2-3/8" x 1-5/8" or 1-7/8"	48048_	4	3.20	
2-7/8" x 1-5/8" or 1-7/8"	48041_	4	3.30	
4" x 1-5/8" or 1-7/8"	48042_	4	3.70	
6-5/8" x 1-5/8" or 1-7/8"	48043_	4	5.90	

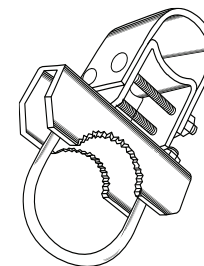

Magna Latches by D&D / Black Polymer

DESCRIPTION	PART NO.	PER SACK	WEIGHT EA.	NOTES
Top Pull - S3	009449	10	1.71	
Vertical Pull - S3	009450	10	1.38	
Round Post Adapter - S3	814X00	10	0.40	

NOTE: The Round Post Adapter fits a 1-3/8" to 1-5/8" frame and a 1-7/8" to 2-7/8" post.

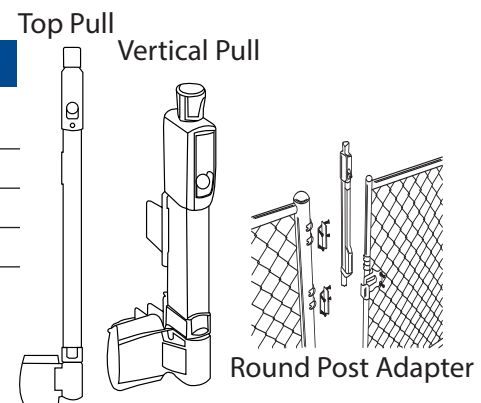

Fork Latch Assembly / Heavy Duty • Pressed Steel – Galvanized • Heavy Mil Includes bolts

DESCRIPTION	PART NO.	PKG QTY.	WEIGHT EA.	NOTES
1-3/8" x 1-7/8"	48054_	10	.96	
1-3/8" x 2-3/8"	48055_	10	1.06	
1-5/8" x 2-3/8"	48056_	10	1.15	

NOTE: This item is assembled.

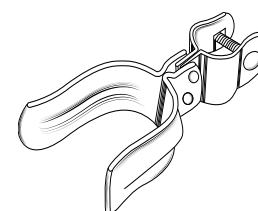

Add the following number to the part no. for desired color:
1-Forest Green 2-Midnight Black 3-Sierra Brown

CL-170

Fork Latch Hangers (Collars) / Pressed Steel – Galvanized • Heavy Mil

DESCRIPTION	PART NO.	PKG QTY.	WEIGHT EA.	NOTES
1-3/8"	48315_	10	.42	
1-5/8"	48147_	10	.50	
1-7/8"	48148_	10	.56	

Use 5/16" x 1-1/4" Carriage Bolt – Pt. #010701 or Pt. #62201_ (Spectra)

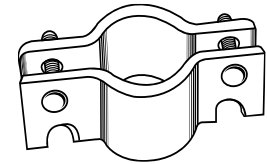

Forks / Heavy Duty • Pressed Steel – Galvanized • Heavy Mil

DESCRIPTION	PART NO.	PKG QTY.	WEIGHT EA.	NOTES
1-3/8"	48071_	10	.29	
1-7/8"	48070_	10	.50	
2-3/8"	48045_	10	.50	
2-7/8"	48046_	10	.55	
4"	48047_	10	.68	

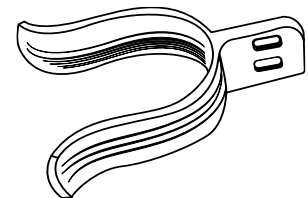

Industrial Latches / Pressed Steel – Galvanized • Heavy Mil (Polyester guides)

NOTE: Optional with 4 Guides and 2 Forks at extra cost.

DESCRIPTION	PART NO.	PKG QTY.	WEIGHT EA.	NOTES
1-5/8" Assembly with Drop Rod	48149_	1	12.00	
1-7/8" Assembly with Drop Rod	48150_	1	12.00	

Assembly with Drop Rod includes: Fork, 3 Guides, Bolts, 1-3/8" x 7" Drop Rod – with Fork welded to Rod

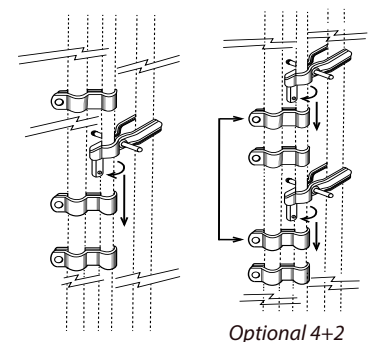

Add the following number to the part no. for desired color:
1-Forest Green 2-Midnight Black 3-Sierra Brown

Chain Link - Heavy Mil Gate Fittings



Gate Ell / Residential Hex Type • Die-Cast Aluminum • Heavy Mil

DESCRIPTION	PART NO.	PKG QTY.	WEIGHT EA.	NOTES
1-3/8"	48156_	40	.48	

Use No. 12 x 3/4" Tek Screw – Pt. #023660

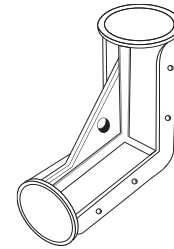

Gate Ells Industrial / Pressed Steel – Galvanized • Heavy Mil

DESCRIPTION	PART NO.	PER SACK	WEIGHT EA.	NOTES
1-5/8"	48152_	8	2.50	

Use 5/16" x 2-1/4" Rivet – Pt. #010774

1-7/8"	48153_	8	2.50	
--------	--------	---	------	--

Use 5/16" x 2-1/2" Rivet – Pt. #010772

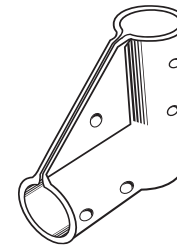

Safe-T Line Tracks Brackets for 1-5/8" Pipe Track / Heavy Duty Pressed Steel – Galvanized • Heavy Mil • Includes bolts

DESCRIPTION	PART NO.	PKG QTY.	WEIGHT EA.	NOTES
For 1-5/8" or 1-7/8" Post	48221_	10	2.55	
For 2-3/8" or 2-7/8" Post	48220_	10	2.65	

NOTE: Pat. No. 3,215,702

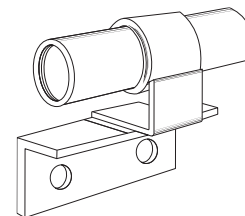

Add the following number to the part no. for desired color:
1-Forest Green 2-Midnight Black 3-Sierra Brown

CL-172

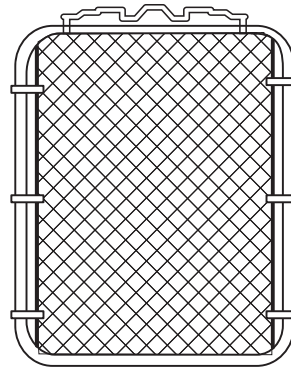

1-3/8" Thrifty Single Swing Gates

NOTE: Without hardware.

OPENING	3' HIGH	42" HIGH	4' HIGH	5' HIGH	6' HIGH
3'	021601	021602	021603	021604	021605
39"	021606	021607	021608	021609	021610
42"	021611	021612	021613	021614	021615
4'	021616	021617	021618	021619	021620

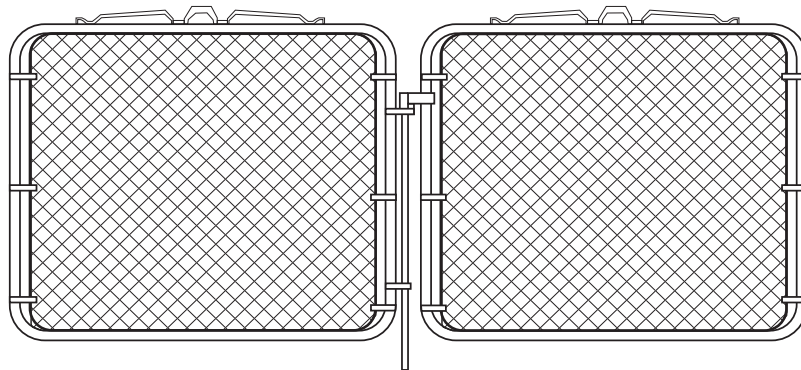

1-3/8" Thrifty Double Swing Gates

NOTE: Without hardware.

OPENING	3' HIGH	42" HIGH	4' HIGH	5' HIGH	6' HIGH
10'	021661	021662	021663	021664	021665
12'	021671	021672	021673	021674	021675

NOTE:

- Fork Latch and Hinges are sold separately. Double Swing gates include E-Z Latch assembly. For gate hardware, refer to Gate Fittings.

Residential Bent Frame Gates

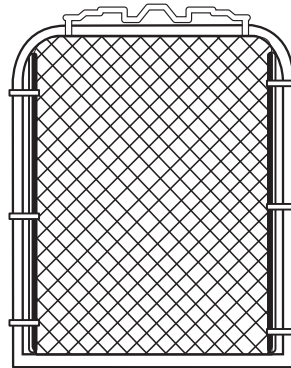

1-3/8" (16 ga) Bent Frame Single Swing Gates

NOTE: Without hardware.

OPENING	3' HIGH	42" HIGH	4' HIGH	5' HIGH	6' HIGH
3'	026101	026102	026103	026104	026105
42"	026108	026109	026110	026111	026112
4'	026115	026116	026117	026118	026119
5'	026122	026123	026124	026125	026126
6'	026129	026130	026131	026132	026133
8'	026136	026137	026138	026139	026140
10'	026143	026144	026145	026146	026147
12'	026150	026151	026152	026153	026154
Less Than 36"	261019	261029	261039	261049	261059
37" to 41"	261089	261099	261109	261119	261129
43" to 47"	261159	261169	261179	261189	261199
49" to 59"	261229	261239	261249	261259	261269
61" to 95"	261369	261379	261389	261399	261409
97" to 119"	261439	261449	261459	261469	261479
121" to 143"	261509	261519	261529	261539	261549

NOTE:

- Fork Latch and Hinges are sold separately. Double Swing gates include E-Z Latch assembly. For gate hardware, refer to Gate Fittings.
- Interior bracing installed as needed on larger panels.

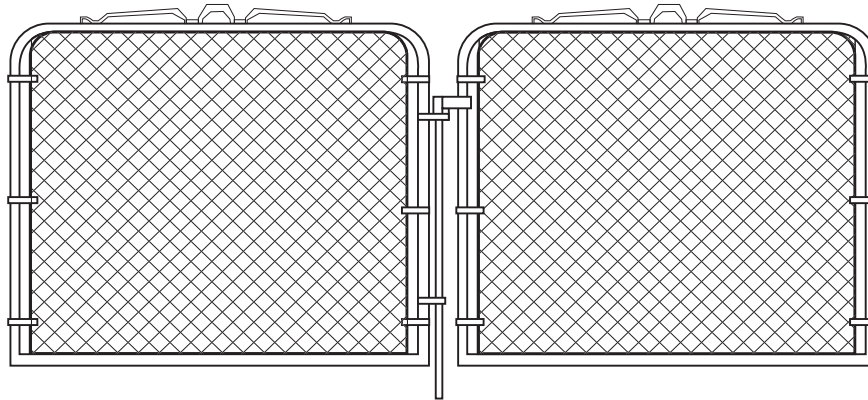

1-3/8" (16 ga) Bent Frame Double Swing Gates

NOTE: Without hardware.

OPENING	3' HIGH	42" HIGH	4' HIGH	5' HIGH	6' HIGH
8'	026301	026302	026303	026304	026305
10'	026315	026316	026317	026318	026319
12'	026329	026330	026331	026332	026333
14'	026336	026337	026338	026339	026340
16'	026343	026344	026345	026346	026347
18'	026350	026351	026352	026353	026354
Less than 120"	263159	263169	263179	263189	263199
121" to 143"	263299	263309	263319	263329	263339
145" to 167"	263369	263379	263389	263399	263409
169" to 215"	263509	263519	263529	263539	263549

NOTE:

- Fork Latch and Hinges are sold separately. Double Swing gates include E-Z Latch assembly. For gate hardware, refer to Gate Fittings.
- Interior bracing installed as needed on larger panels.

18 Gauge Square Welded Frame Gates

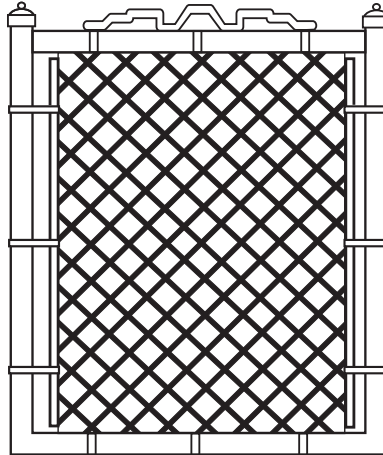

1-3/8" (18 ga) Square Welded Single Swing Gates

NOTE: Without hardware - includes caps and scroll.

OPENING	3' HIGH	42" HIGH	4' HIGH	5' HIGH	6' HIGH
3'	026400	026401	026402	026403	026404
42"	026405	026406	026407	026408	026409
4'	026410	026411	026412	026413	026414
5'	026415	026416	026417	026418	026419
8'	024C01	026421	026422	026423	026424
10'	024C02	026431	026432	026433	026434
12'	024C03	024C04	026437	026438	026439
Less Than 36"	264009	264019	264029	264039	264049
37" to 41"	264059	264069	264079	264089	264099
43" to 47"	264109	264119	264129	264139	264149
49" to 59"	264159	264169	264179	264189	264199
61" to 95"	264209	264219	264229	264239	264249
97" to 119"/120"	264309	264319	264329	264339	264349
121" to 143"	264359	264369	264379	264389	264399

NOTE:

- Fork Latch and Hinges are sold separately. Double Swing gates include E-Z Latch assembly. For gate hardware, refer to Gate Fittings.
- Interior bracing installed as needed on larger panels.

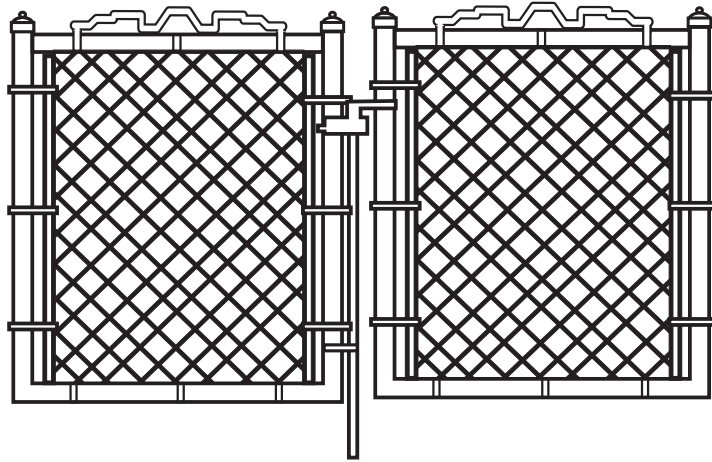

1-3/8" (18 ga) Square Welded Double Swing Gates

NOTE: Without hardware - includes caps and scroll.

OPENING	3' HIGH	42" HIGH	4' HIGH	5' HIGH	6' HIGH
10'	026470	024C05	026472	026473	026474
12'	024C06	026476	026477	026478	026479
14'	024C07	024C08	026482	026483	026484
18'	024C09	024C10	026487	026488	024C11
Less Than 120"	264709	264719	264729	264739	264749
121" to 143"	264759	264769	264779	264789	264799
145" to 167"	264809	264819	264829	264839	264849
169" to 215"	264859	264869	264879	264889	264899

NOTE:

- Fork Latch and Hinges are sold separately. Double Swing gates include E-Z Latch assembly. For gate hardware, refer to Gate Fittings.
- Interior bracing installed as needed on larger panels.

17 Gauge Square Welded Frame Gates

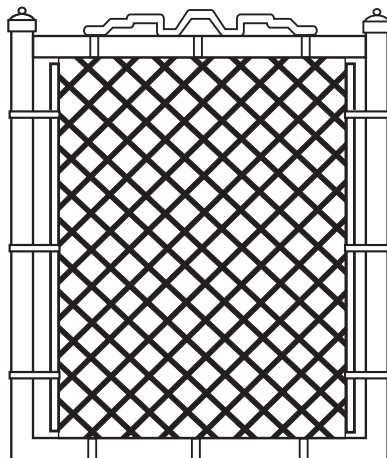

1-3/8" (17 ga) Square Welded Single Swing Gates

NOTE: Without hardware - includes caps and scroll.

OPENING	3' HIGH		42" HIGH		4' HIGH		5' HIGH		6' HIGH	
	GALV	SPECTRA 9 GA.	GALV	SPECTRA 9 GA.	GALV	SPECTRA 9 GA.	GALV	SPECTRA 9 GA.	GALV	SPECTRA 9 GA.
3'	026600	63800_	026601	63801_	026602	63802_	026603	63803_	026604	63804_
42"	026606	63805_	026607	63806_	026608	63807_	026609	63808_	026610	63809_
4'	026612	63810_	026613	63811_	026614	63197_	026615	63812_	026616	63198_
5'	026618	63813_	026619	63814_	026620	63021_	026621	63815_	026622	63816_
6'	—	63817_	—	63818_	026626	63819_	026627	63820_	026628	63821_
8'	026630	63822_	026631	63823_	026632	63824_	026633	63825_	026634	63826_
10'	026636	63827_	026637	63828_	026638	63829_	026639	63830_	026640	63831_
12'	026642	—	026643	—	026644	—	026645	—	026646	—
Less Than 36"	266009	63700_	266019	63701_	266029	63702_	266039	63703_	266049	63704_
37" to 41"	266069	63705_	266079	63706_	266089	63707_	266099	63708_	266109	63709_
43" to 47"	266129	63710_	266139	63711_	266149	63712_	266159	63713_	266169	63714_
49" to 59"	255189	63715_	266199	63716_	266209	63717_	266219	63718_	266229	63719_
61" to 95"	266309	63720_	266319	63721_	266329	63722_	266339	63723_	266349	63724_
97" to 119"/120"	266369	63725_	266379	63726_	266389	63727_	266399	63728_	266409	63729_
121" to 143"	266429	63730_	266439	63731_	266449	63732_	266459	63733_	266469	63734_

NOTE:

- Fork Latch and Hinges are sold separately. Double Swing gates include E-Z Latch assembly. For gate hardware, refer to Gate Fittings.
- Interior bracing installed as needed on larger panels.

Add the following number to the part no. for desired color:

1-Forest Green 2-Midnight Black 3-Sierra Brown

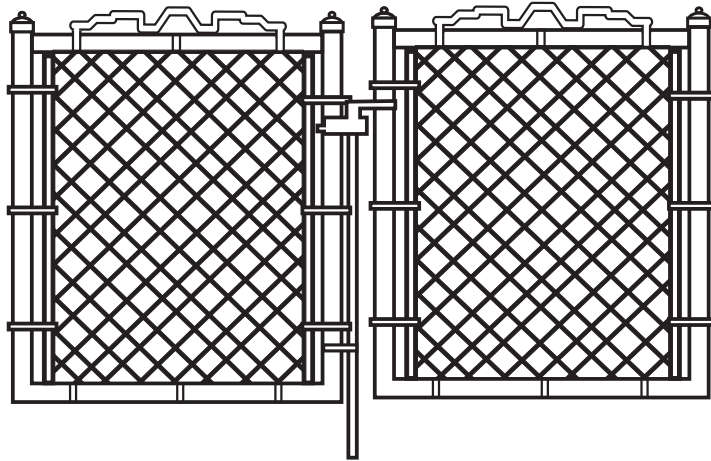

1-3/8" (17 ga) Square Welded Double Swing Gates

NOTE: Without hardware - includes caps and scroll.

OPENING	3' HIGH		42" HIGH		4' HIGH		5' HIGH		6' HIGH	
	GALV	SPECTRA 9 GA.	GALV	SPECTRA 9 GA.	GALV	SPECTRA 9 GA.	GALV	SPECTRA 9 GA.	GALV	SPECTRA 9 GA.
8'	—	63832_	—	63833_	N00829	63834_	—	63835_	—	63836_
10'	026712	63837_	026713	63838_	026714	63839_	026715	63840_	026716	63841_
12'	026724	63842_	026725	63843_	026726	63844_	026727	63845_	026728	63846_
14'	026753	—	026754	—	026755	—	026756	—	026757	—
16'	—	63847_	—	63848_	—	63849_	—	63850_	—	63851_
18'	026758	—	026759	—	026760	—	026761	—	026762	—
Less Than 120"	267129	63735_	267139	63736_	267149	63737_	267159	63738_	267169	63739_
121" to 143"	267249	63740_	267259	63741_	267269	63742_	267279	63743_	267289	63744_
145" to 167"	267539	63745_	267549	63746_	267559	63747_	267569	63748_	267579	63749_
169" to 215"	267589	—	267599	—	267609	—	267619	—	267629	—

NOTE:

- Fork Latch and Hinges are sold separately. Double Swing gates include E-Z Latch assembly. For gate hardware, refer to Gate Fittings.
- Interior bracing installed as needed on larger panels.

Add the following number to the part no. for desired color:

1-Forest Green 2-Midnight Black 3-Sierra Brown

Aluminum Residential Gates

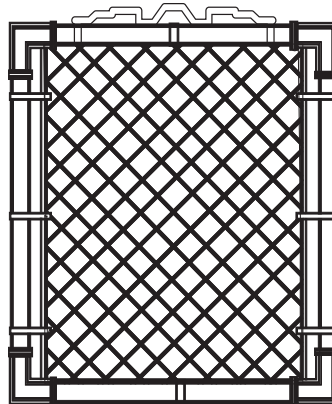

1-3/8" (17 ga) Aluminum Ell Single Swing Gates

NOTE: Without hardware - includes caps and scroll.

OPENING	3' HIGH		42" HIGH		4' HIGH		5' HIGH		6' HIGH	
	GALV	SPECTRA 9 GA.	GALV	SPECTRA 9 GA.	GALV	SPECTRA 9 GA.	GALV	SPECTRA 9 GA.	GALV	SPECTRA 9 GA.
3'	025500	63001_	025501	63002_	025502	63003_	025503	63004_	025504	63005_
42"	025505	63008_	025506	63009_	025507	63010_	025508	63011_	025509	63012_
4'	025510	63015_	025511	63016_	025512	63017_	025513	63018_	025514	63019_
5'	025515	199100*	025516	63040_**	025517	003097◇	025518	63028_†	025519	63039_

* Green part number = 637501, brown part number = 637503

** Green part number = 637521

◇ Green part number = 630351, brown part number = 630323

† Brown part number = 637523

NOTE:

- Fork Latch and Hinges are sold separately. Double Swing gates include E-Z Latch assembly. For gate hardware, refer to Gate Fittings.
- For irregular size gates, add \$10.00 per panel to the next larger size gate.
- Interior bracing installed as needed on larger panels.

Add the following number to the part no. for desired color:

1-Forest Green 2-Midnight Black 3-Sierra Brown

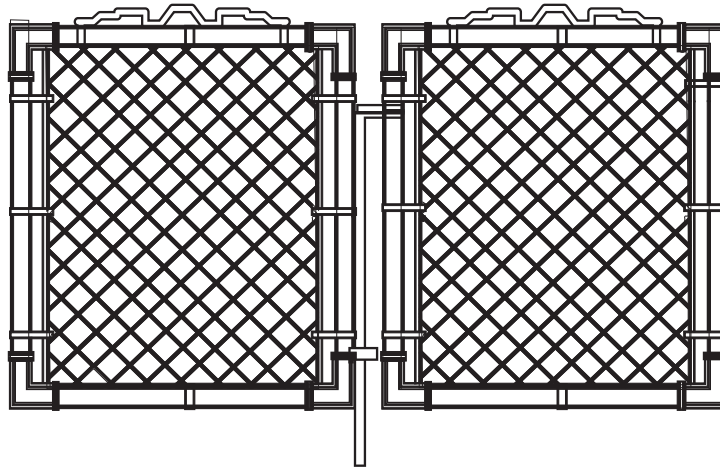

1-3/8" (17 ga) Aluminum Ell Double Swing Gates

NOTE: Without hardware - includes caps and scroll.

OPENING	3' HIGH		42" HIGH		4' HIGH		5' HIGH		6' HIGH	
	GALV	SPECTRA 9 GA.	GALV	SPECTRA 9 GA.	GALV	SPECTRA 9 GA.	GALV	SPECTRA 9 GA.	GALV	SPECTRA 9 GA.
8'	—	—	—	—	—	—	—	632042*	—	633112*
10'	025540	63114_	025541	63115_	025542	63116_	025543	63117_	025544	63118_
12'	025545	63128_	025546	63129_	025547	63130_	025548	63131_	025549	63132_
14'	—	63142_	—	63143_	—	63144_	—	63145_	—	63146_
16'	—	—	—	—	—	005500†	—	632032*	—	574500*
Less Than 120"	255409	—	255419	—	255429	278C00*	255439	631232*	255449	—
121" to 143"	255459	—	255469	—	255479	—	255489	—	255499	—

* Displaying the black part number

† Brown part number = 035Y00

NOTE:

- Fork Latch and Hinges are sold separately. Double Swing gates include E-Z Latch assembly. For gate hardware, refer to Gate Fittings.
- For irregular size gates, add \$10.00 per panel to the next larger size gate.
- Interior bracing installed as needed on larger panels.

Add the following number to the part no. for desired color:

1-Forest Green 2-Midnight Black 3-Sierra Brown

Chain Link - Gates



Industrial Single Swing Gates

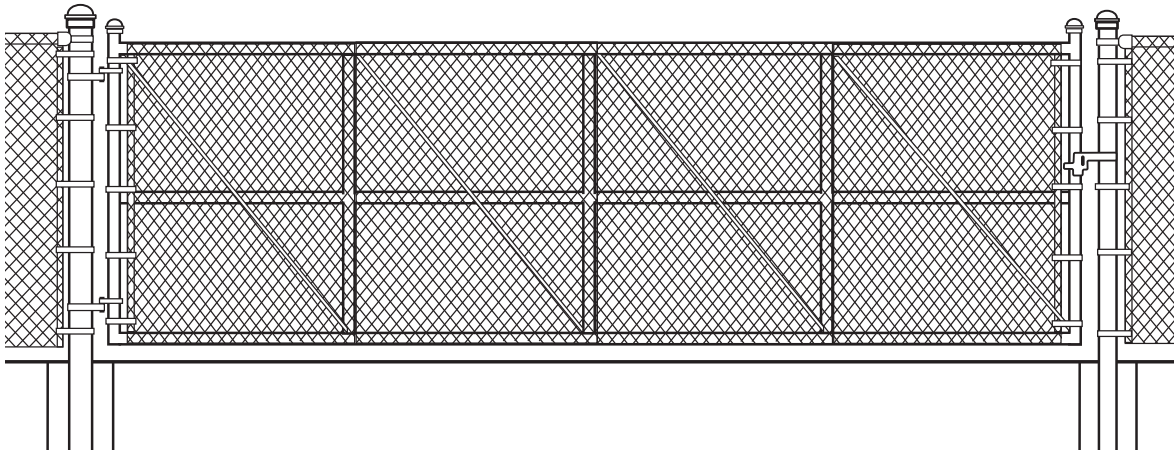
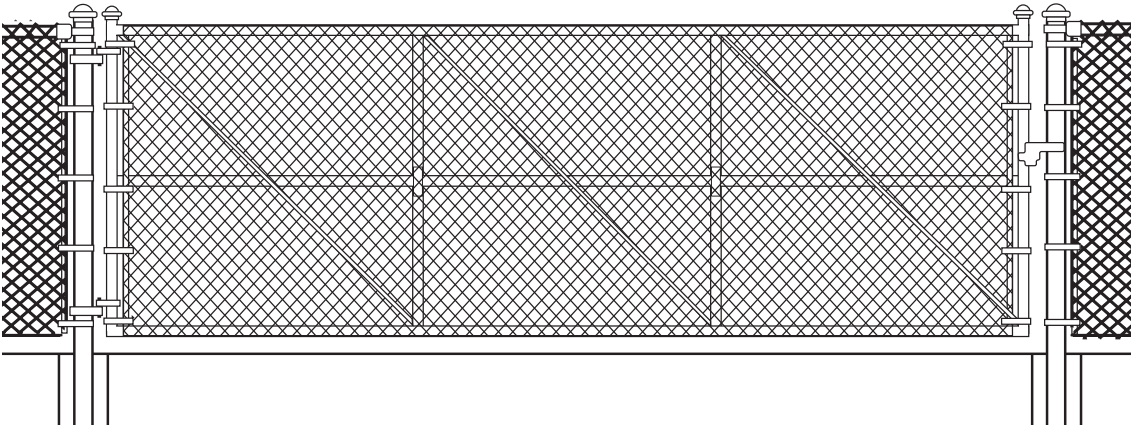
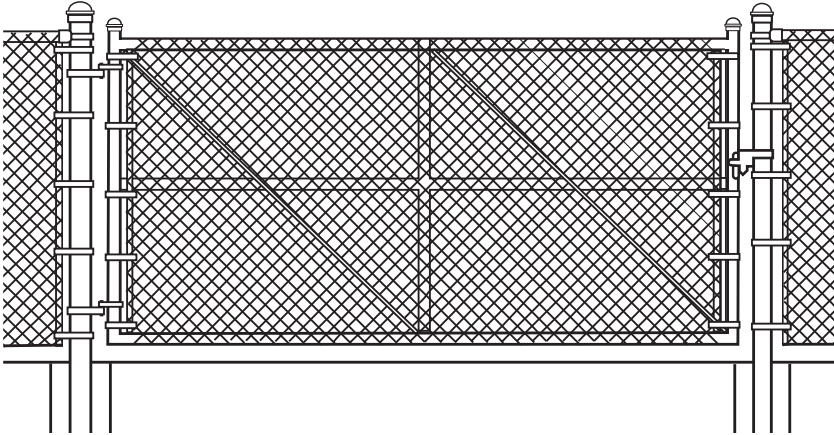
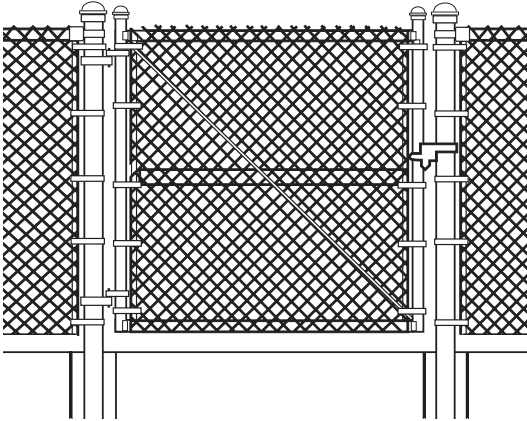

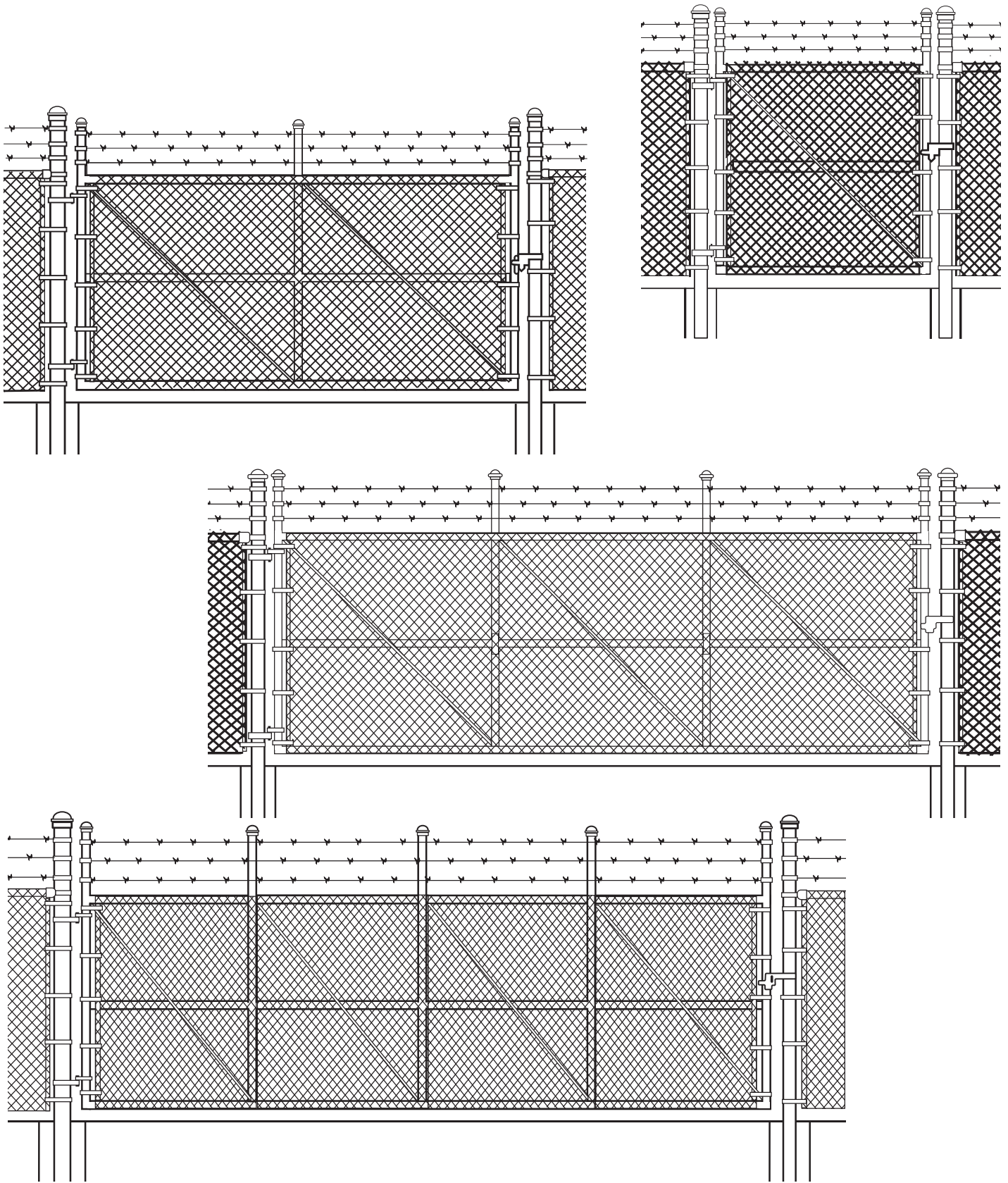

SWING GATE SPECIFICATIONS (Industrial and Commercial)

Frame Size

Standard gates are manufactured from the pipe sizes listed. Other sizes are available on special quotation (All Industrial Gates — Non Stock).

Construction

All gates are welded corner construction. Gates include the necessary Bracing and Truss Rods. Gates are manufactured to fit the opening between posts. Specify type and size of gate hardware (sold separately), so gate can be manufactured with proper clearances. Ground clearance is 2".

Fabric

Standard fabric will be 2" mesh, 9 gauge, zinc-coated steel. Other sizes and finishes are available on special quotation.

Hardware

Single Gates include caps; Double Gates include caps and industrial drop rod assembly. Please refer to the Gate Fittings section for your specific hardware needs.

Barb Wire

Gate height is based on overall height of the gate, either with or without barb wire. Barb wire will be 3 strands of 12 1/2 gauge, 4 point.

Gate Posts

Gate Posts are sold separately. Refer to post chart for recommended size.

Gate Post Recommendation

O.D. FRAME SIZE	GATE HEIGHT.	GATE LEAF WIDTH	O.D. PIPE SIZE.	DQ 40 MIN. WT. (LB. PER FT.)	F.W. MIN. WT. (LB. PER FT.)
1-5/8"	6' OR LESS	UP TO 4'	2-3/8"	3.12	3.65
1-5/8"	6' OR LESS	OVER 4' TO 10'	2-7/8"	4.64	5.79
1-5/8"	6' OR LESS	OVER 10' TO 18'	4"	6.56	9.11
1-5/8"	OVER 6'	UP TO 6'	2-7/8"	4.64	5.79
1-5/8"	OVER 6'	OVER 6' TO 12'	4"	6.56	9.11
1-5/8"	OVER 6'	OVER 12' TO 18'	6-5/8"	*	18.97
1-5/8"	OVER 6'	OVER 18' TO 24'	8-5/8"	*	28.55
1-7/8"	ANY HEIGHT	UP TO 6'	2-7/8"	4.64	5.79
1-7/8"	ANY HEIGHT	OVER 6' TO 12'	4"	6.56	9.11
1-7/8"	ANY HEIGHT	OVER 12' TO 18'	6-5/8"	*	18.97
1-7/8"	ANY HEIGHT	OVER 18' TO 24'	8-5/8"	*	28.55

Refer to ASTM F567 for minimum requirements for setting gate posts.

Extras

For Gate Ells add: Single – \$15.00; Double – \$30.00.

For SlatMaster™ chain-link fabric, a per square foot charge will be added.

Industrial Single Swing Gates

NOTE: Without barb wire. Without hardware.

OPENING	FRAME TYPE	4' HIGH			5' HIGH			6' HIGH		
		GALV	SPECTRA	HEAVY MIL	GALV	SPECTRA	HEAVY MIL	GALV	SPECTRA	HEAVY MIL
Less Than 3'6"	1-5/8" Tube	024094	—	—	024101	—	—	024141	—	—
	1-5/8" CQ/STR	024095	637A0_	—	024102	637A1_	64000_	024142	637A2_	64025_
	1-5/8" DQ/FW	024096	637B2_	—	024103	637B4_	64001_	024143	637B5_	64026_
	1-7/8" DQ/FW	024097	637D4_	—	024104	637D5_	64002_	024144	637D6_	64027_
3'6" to 4'5"	1-5/8" Tube	025190	—	—	024109	—	—	024149	—	—
	1-5/8" CQ/STR	025191	637F6_	—	024110	637F7_	64003_	024150	637F8_	64028_
	1-5/8" DQ/FW	025192	637G8_	—	024111	637G9_	64004_	024151	637H0_	64029_
	1-7/8" DQ/FW	025193	637I0_	—	024112	637I1_	64005_	024152	637I2_	64030_
4'6" to 5'5"	1-5/8" Tube	025195	—	—	024113	—	—	024153	—	—
	1-5/8" CQ/STR	025196	637J2_	—	024114	637J3_	64006_	024154	637J4_	64031_
	1-5/8" DQ/FW	025197	637K4_	—	024115	637K5_	64007_	024155	637K6_	64032_
	1-7/8" DQ/FW	025198	637L6_	—	024116	637L7_	64008_	024156	637L8_	64033_
5'6" to 6'11"	1-5/8" Tube	025200	—	—	024117	—	—	024157	—	—
	1-5/8" CQ/STR	025201	637M8_	—	024118	637M9_	64009_	024158	637N0_	64034_
	1-5/8" DQ/FW	025202	637N9_	—	024119	637Q0_	64010_	024159	637Q1_	64035_
	1-7/8" DQ/FW	025203	637P1_	—	024120	637P2_	64011_	024160	637P3_	64036_
7'0" to 8'11"	1-5/8" Tube	025205	—	—	024121	—	—	024161	—	—
	1-5/8" CQ/STR	025206	637R3_	—	024122	637R4_	64012_	024162	637R5_	64037_
	1-5/8" DQ/FW	025207	637S5_	—	024123	637S6_	64013_	024163	637S7_	64038_
	1-7/8" DQ/FW	025208	637T7_	—	024124	637T8_	64014_	024164	637T9_	64039_
9'0" to 10'11"	1-5/8" CQ/STR	025210	—	—	024125	—	—	024165	—	—
	1-5/8" DQ/FW	025211	637U9_	—	024126	637V0_	64015_	024166	637V1_	64040_
	1-7/8" DQ/FW	025212	637W1_	—	024128	637W2_	64016_	024168	637W3_	64041_
11'0" to 13'11"	1-5/8" CQ/STR	025214	—	—	024129	—	—	024169	—	—
	1-5/8" DQ/FW	025215	637X3_	—	024130	637X4_	64017_	024170	637X5_	64042_
	1-7/8" DQ/FW	025216	637Y5_	—	024132	637Y6_	64018_	024172	637Y7_	64043_
14'0" to 16'11"	1-5/8" CQ/STR	025218	—	—	024133	—	—	024173	—	—
	1-5/8" DQ/FW	025219	637Z7_	—	024134	637Z8_	64019_	024174	637Z9_	64044_
	1-7/8" DQ/FW	025220	638A9_	—	024136	638B0_	64020_	024176	638B1_	64045_
17'0" to 20'11"	1-5/8" CQ/STR	025222	—	—	024137	—	—	024177	—	—
	1-5/8" DQ/FW	025223	638C1_	—	024138	638C2_	64021_	024178	638C3_	64046_
	1-7/8" DQ/FW	025224	638F2_	—	024140	638F3_	64022_	024180	638F4_	64047_
21'0" to 24'0"	1-5/8" CQ/STR	025226	—	—	024335	—	—	024340	—	—
	1-5/8" DQ/FW	025227	638G4_	—	024336	638G5_	—	024342	638G6_	—
	1-7/8" DQ/FW	025228	638H6_	—	024338	638H7_	—	024344	638H8_	—

Add the following number to the part no. for desired color:

1-Forest Green 2-Midnight Black 3-Sierra Brown

Industrial Single Swing Gates

Industrial Single Swing Gates

NOTE: Without barb wire. Without hardware.

OPENING	FRAME TYPE	6'+1 HIGH			7' HIGH			7'+1 HIGH		
		GALV	SPECTRA	HEAVY MIL	GALV	SPECTRA	HEAVY MIL	GALV	SPECTRA	HEAVY MIL
Less Than 3'6"	1-5/8" Tube	241813	—	—	024181	—	—	242213	—	—
	1-5/8" CQ/STR	241823	637A3_	64048_	024182	637A4_	64048_	242223	637A5_	64117_
	1-5/8" DQ/FW	241833	637B6_	64049_	024183	637B7_	64049_	242233	637B8_	64118_
	1-7/8" DQ/FW	241843	637D7_	64050_	024184	637D8_	64050_	242243	637D9_	64119_
3'6" to 4'5"	1-5/8" Tube	241893	—	—	024189	—	—	242293	—	—
	1-5/8" CQ/STR	241903	637F9_	64051_	024190	637G0_	64051_	242303	637G1_	64120_
	1-5/8" DQ/FW	241913	637H1_	64052_	024191	637H2_	64052_	242313	637H3_	64121_
	1-7/8" DQ/FW	241923	637I3_	64053_	024192	637I4_	64053_	242323	637I5_	64122_
4'6" to 5'5"	1-5/8" Tube	241933	—	—	024193	—	—	242333	—	—
	1-5/8" CQ/STR	241943	637J5_	64054_	024194	637J6_	64054_	242343	637J7_	64123_
	1-5/8" DQ/FW	241953	637K7_	64055_	024195	637K8_	64055_	242353	637K9_	64124_
	1-7/8" DQ/FW	241963	637L9_	64056_	024196	637M0_	64056_	242363	637M1_	64125_
5'6" to 6'11"	1-5/8" Tube	241973	—	—	024197	—	—	251C21	—	—
	1-5/8" CQ/STR	241983	639R5_	64057_	024198	637N1_	64057_	242383	637N2_	64126_
	1-5/8" DQ/FW	241993	637Q2_	64058_	024199	637Q3_	64058_	242393	637Q4_	64127_
	1-7/8" DQ/FW	242003	637P4_	64059_	024200	637P5_	64059_	242403	637P6_	64128_
7'0" to 8'11"	1-5/8" Tube	242013	—	—	024201	—	—	251C30	—	—
	1-5/8" CQ/STR	242023	637R6_	64060_	024202	637R7_	64060_	242423	637R8_	64129_
	1-5/8" DQ/FW	242033	637S8_	64061_	024203	637S9_	64061_	242433	637T0_	64130_
	1-7/8" DQ/FW	242043	637U0_	64062_	024204	637U1_	64062_	242443	637U2_	64131_
9'0" to 10'11"	1-5/8" CQ/STR	242053	—	—	024205	—	—	242453	—	—
	1-5/8" DQ/FW	242063	637V2_	64063_	024206	637V3_	64063_	242463	637V4_	64132_
	1-7/8" DQ/FW	242083	637W4_	64064_	024208	637W5_	64064_	242483	637W6_	64133_
11'0" to 13'11"	1-5/8" CQ/STR	242093	—	—	024209	—	—	242493	—	—
	1-5/8" DQ/FW	242103	637X6_	64065_	024210	637X7_	64065_	242503	637X8_	64134_
	1-7/8" DQ/FW	242123	637Y8_	64066_	024212	637Y9_	64066_	242523	637Z0_	64135_
14'0" to 16'11"	1-5/8" CQ/STR	242133	—	—	024213	—	—	242533	—	—
	1-5/8" DQ/FW	242143	638A0_	64067_	024214	638A1_	64067_	242543	638A2_	64136_
	1-7/8" DQ/FW	242163	638B2_	64068_	024216	638B3_	64068_	242563	638B4_	64137_
17'0" to 20'11"	1-5/8" CQ/STR	242173	—	—	024217	—	—	242573	—	—
	1-5/8" DQ/FW	242183	638C4_	64069_	024218	638C5_	64069_	242583	638C6_	64138_
	1-7/8" DQ/FW	242203	638F5_	64070_	024220	638F6_	64070_	242603	638F7_	64139_
21'0" to 24'0"	1-5/8" CQ/STR	243503	—	—	024350	—	—	243603	—	—
	1-5/8" DQ/FW	243523	638G7_	—	024352	638G8_	—	243623	638G9_	—
	1-7/8" DQ/FW	243543	638H9_	—	024354	638I0_	—	243643	638I1_	—

Add the following number to the part no. for desired color:

1-Forest Green 2-Midnight Black 3-Sierra Brown

Industrial Single Swing Gates

NOTE: Without barb wire. Without hardware.

OPENING	FRAME TYPE	8' HIGH			8'+1 HIGH			10' HIGH		
		GALV	SPECTRA	HEAVY MIL	GALV	SPECTRA	HEAVY MIL	GALV	SPECTRA	HEAVY MIL
Less Than 3'6"	1-5/8" Tube	024221	—	—	010539	—	—	025C11	—	—
	1-5/8" CQ/STR	024222	637A6_	64117_	010540	637A7_	—	024107	637A8_	—
	1-5/8" DQ/FW	024223	637B9_	64118_	010541	637C9_	—	025B02	637D0_	—
	1-7/8" DQ/FW	024224	637F0_	64119_	—	637F1_	—	005264	637F2_	—
3'6" to 4'5"	1-5/8" Tube	024229	—	—	004775	—	—	025B05	—	—
	1-5/8" CQ/STR	024230	637G2_	64120_	005351	637G3_	—	036694	637G4_	—
	1-5/8" DQ/FW	024231	637H4_	64121_	005468	637H5_	—	781D00	637H6_	—
	1-7/8" DQ/FW	024232	637I6_	64122_	593F00	637I7_	—	025B08	637I8_	—
4'6" to 5'5"	1-5/8" Tube	024233	—	—	010542	—	—	025B10	—	—
	1-5/8" CQ/STR	024234	637J8_	64123_	010543	637J9_	—	025B12	637K0_	—
	1-5/8" DQ/FW	024235	637L0_	64124_	007399	637L1_	—	005483	637L2_	—
	1-7/8" DQ/FW	024236	637M2_	64125_	010544	637M3_	—	025B15	637M4_	—
5'6" to 6'11"	1-5/8" Tube	024237	—	—	010545	—	—	025B17	—	—
	1-5/8" CQ/STR	024238	637N3_	64126_	010546	637N4_	—	006467	637N5_	—
	1-5/8" DQ/FW	024239	637Q5_	64127_	010547	637Q6_	—	025B19	637Q7_	—
	1-7/8" DQ/FW	024240	637P7_	64128_	010548	637P8_	—	025B21	637P9_	—
7'0" to 8'11"	1-5/8" Tube	024241	—	—	010549	—	—	025B23	—	—
	1-5/8" CQ/STR	024242	637R9_	64129_	010550	637S0_	—	036697	637S1_	—
	1-5/8" DQ/FW	024243	637T1_	64130_	010564	637T2_	—	025B26	637T3_	—
	1-7/8" DQ/FW	024244	637U3_	64131_	010565	637U4_	—	025B28	637U5_	—
9'0" to 10'11"	1-5/8" CQ/STR	024245	—	—	010566	—	—	036698	—	—
	1-5/8" DQ/FW	024246	637V5_	64132_	894G00	637V6_	—	025B31	637V7_	—
	1-7/8" DQ/FW	024248	637W7_	64133_	010567	637W8_	—	025B33	637W9_	—
11'0" to 13'11"	1-5/8" CQ/STR	024249	—	—	010568	—	—	025B35	—	—
	1-5/8" DQ/FW	024250	637X9_	64134_	010569	637Y0_	—	025B37	637Y1_	—
	1-7/8" DQ/FW	024252	637Z1_	64135_	010570	637Z2_	—	025B39	637Z3_	—
14'0" to 16'11"	1-5/8" CQ/STR	024253	—	—	010571	—	—	025B41	—	—
	1-5/8" DQ/FW	024254	638A3_	64136_	010572	638A4_	—	025B43	638A5_	—
	1-7/8" DQ/FW	024256	638B5_	64137_	010573	638B6_	—	025B45	638B7_	—
17'0" to 20'11"	1-5/8" CQ/STR	024257	—	—	010574	—	—	—	—	—
	1-5/8" DQ/FW	024258	638C7_	64138_	010575	638C8_	—	025B48	638C9_	—
	1-7/8" DQ/FW	024260	638F8_	64139_	010576	638F9_	—	025B50	638G0_	—
21'0" to 24'0"	1-5/8" CQ/STR	024360	—	—	010577	—	—	025B52	—	—
	1-5/8" DQ/FW	024362	638H0_	—	010578	638H1_	—	025B54	638H2_	—
	1-7/8" DQ/FW	024364	638I2_	—	010579	638I3_	—	025B56	638I4_	—

Add the following number to the part no. for desired color:

1-Forest Green 2-Midnight Black 3-Sierra Brown

Industrial Single Swing Gates

Industrial Single Swing Gates

NOTE: Without barb wire. Without hardware.

OPENING	FRAME TYPE	10'+1 HIGH			12' HIGH			12'+1 HIGH		
		GALV	SPECTRA	HEAVY MIL	GALV	SPECTRA	HEAVY MIL	GALV	SPECTRA	HEAVY MIL
Less Than 3'6"	1-5/8" Tube	251D26	—	—	025C12	—	—	251D27	—	—
	1-5/8" CQ/STR	251C01	637A9_	—	025B01	637B0_	—	251C02	637B1_	—
	1-5/8" DQ/FW	251C03	637D1_	—	025B03	637D2_	—	251C04	637D3_	—
	1-7/8" DQ/FW	251C05	637F3_	—	025B04	637F4_	—	251C06	637F5_	—
3'6" to 4'5"	1-5/8" Tube	251C07	—	—	025B06	—	—	251C08	—	—
	1-5/8" CQ/STR	251C09	637G5_	—	025B07	637G6_	—	251C10	637G7_	—
	1-5/8" DQ/FW	320G00	637H7_	—	—	637H8_	—	251C11	637H9_	—
	1-7/8" DQ/FW	251C12	637I9_	—	025B09	637J0_	—	251C13	637J1_	—
4'6" to 5'5"	1-5/8" Tube	251C14	—	—	025B11	—	—	251C15	—	—
	1-5/8" CQ/STR	251C16	637K1_	—	025B13	637K2_	—	251C17	637K3_	—
	1-5/8" DQ/FW	251C18	637L3_	—	025B14	637L4_	—	251C19	637L5_	—
	1-7/8" DQ/FW	251C20	637M5_	—	025B16	637M6_	—	—	637M7_	—
5'6" to 6'11"	1-5/8" Tube	251C22	—	—	025B18	—	—	251C23	—	—
	1-5/8" CQ/STR	251C24	637N6_	—	024146	637N7_	—	251C25	637N8_	—
	1-5/8" DQ/FW	251C26	637Q8_	—	025B20	637Q9_	—	251C27	637P0_	—
	1-7/8" DQ/FW	251C28	637R0_	—	025B22	637R1_	—	251C29	637R2_	—
7'0" to 8'11"	1-5/8" Tube	251C31	—	—	025B24	—	—	251C32	—	—
	1-5/8" CQ/STR	251C33	637S2_	—	025B25	637S3_	—	251C34	637S4_	—
	1-5/8" DQ/FW	251C35	637T4_	—	025B27	637T5_	—	251C36	637T6_	—
	1-7/8" DQ/FW	251C37	637U6_	—	025B29	637U7_	—	251C38	637U8_	—
9'0" to 10'11"	1-5/8" CQ/STR	251C39	—	—	025B30	—	—	251C40	—	—
	1-5/8" DQ/FW	251C41	637V8_	—	025B32	637V9_	—	251C42	637W0_	—
	1-7/8" DQ/FW	251C43	637X0_	—	025B34	637X1_	—	251C44	637X2_	—
11'0" to 13'11"	1-5/8" CQ/STR	251C45	—	—	025B36	—	—	251C46	—	—
	1-5/8" DQ/FW	251C47	637Y2_	—	025B38	637Y3_	—	251C48	637Y4_	—
	1-7/8" DQ/FW	251C49	637Z4_	—	025B40	637Z5_	—	251C50	637Z6_	—
14'0" to 16'11"	1-5/8" CQ/STR	251C51	—	—	025B42	—	—	251C52	—	—
	1-5/8" DQ/FW	251C52	638A6_	—	025B44	638A7_	—	251C53	638A8_	—
	1-7/8" DQ/FW	251C55	638B8_	—	025B46	638B9_	—	251C56	638C0_	—
17'0" to 20'11"	1-5/8" CQ/STR	251C57	—	—	025B47	—	—	251C58	—	—
	1-5/8" DQ/FW	251C59	638D9_	—	025B49	638F0_	—	251C60	638F1_	—
	1-7/8" DQ/FW	251C61	638G1_	—	025B51	638G2_	—	251C62	638G3_	—
21'0" to 24'0"	1-5/8" CQ/STR	251C63	—	—	025B53	—	—	251C64	—	—
	1-5/8" DQ/FW	251C65	638H3_	—	025B55	638H4_	—	251C66	638H5_	—
	1-7/8" DQ/FW	251C67	638I5_	—	025B57	638I6_	—	251C68	638I7_	—

Add the following number to the part no. for desired color:

1-Forest Green 2-Midnight Black 3-Sierra Brown

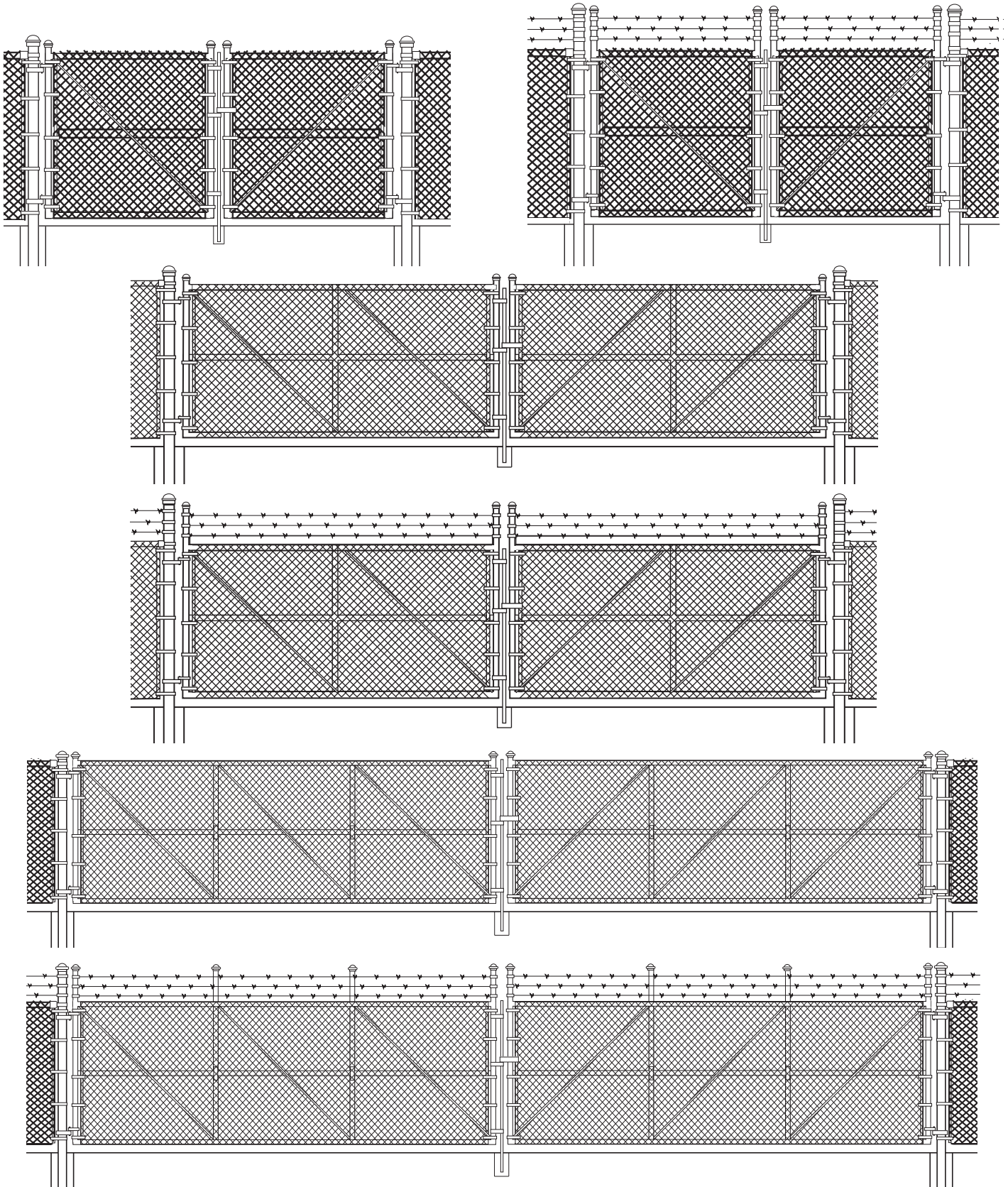

Industrial Double Swing Gates

Industrial Double Swing Gates

NOTE: Without barb wire. Without hardware.

OPENING	FRAME TYPE	4' HIGH			5' HIGH			6' HIGH		
		GALV	SPECTRA	HEAVY MIL	GALV	SPECTRA	HEAVY MIL	GALV	SPECTRA	HEAVY MIL
Less Than 10'0"	1-5/8" Tube	010803	—	—	010807	—	—	010811	—	—
	1-5/8" CQ/STR	010804	638I8_	—	010808	638I9_	—	010812	638J0_	—
	1-5/8" DQ/FW	010805	638K0_	—	010809	638K1_	—	010813	638K2_	—
	1-7/8" DQ/FW	010806	638L2_	—	010810	638L3_	—	010814	638L4_	—
10'0" to 13'11"	1-5/8" Tube	025182	—	—	025005	—	—	025049	—	—
	1-5/8" CQ/STR	025183	638M4_	—	025006	638M5_	64140_	025050	638M6_	64152_
	1-5/8" DQ/FW	025184	638N6_	—	025007	638N7_	64141_	025051	638N8_	64153_
	1-7/8" DQ/FW	025185	638P8_	—	025008	638P9_	64142_	025052	638Q0_	64154_
14'0" to 17'11"	1-5/8" Tube	025169	—	—	025013	—	—	025057	—	—
	1-5/8" CQ/STR	025173	638R0_	—	025014	638R1_	64143_	025058	638R2_	64155_
	1-5/8" DQ/FW	025177	638S2_	—	025015	638S3_	64144_	025059	638S4_	64156_
	1-7/8" DQ/FW	025178	638T4_	—	025016	638T5_	64145_	025060	638T6_	64157_
18'0" to 21'11"	1-5/8" CQ/STR	025125	—	—	025021	—	—	025065	N00503*	—
	1-5/8" DQ/FW	025129	638U6_	—	025022	638U7_	64146_	025066	638U8_	64158_
	1-7/8" DQ/FW	025165	638V8_	—	025024	638V9_	64147_	025068	638W0_	64159_
22'0" to 26'11"	1-5/8" CQ/STR	025077	—	—	025029	—	—	025073	—	—
	1-5/8" DQ/FW	025081	638X0_	—	025030	638X1_	64148_	025074	638X2_	64160_
	1-7/8" DQ/FW	025121	638Y2_	—	025032	638Y3_	64149_	025076	638Y4_	64161_
27'0" to 33'0"/33'11"	1-5/8" CQ/STR	025033	—	—	025042	—	—	025086	—	—
	1-5/8" DQ/FW	025037	638Z4_	—	025043	638Z5_	64150_	025087	638Z6_	64162_
	1-7/8" DQ/FW	025041	639A6_	—	025044	639A7_	64151_	025088	639A8_	64163_
34'0" to 39'11"	1-5/8" CQ/STR	010671	—	—	025B95	—	—	006427	—	—
	1-5/8" DQ/FW	010672	—	—	010675	—	—	010677	—	—
	1-7/8" DQ/FW	010673	—	—	010676	—	—	010678	N00206*	—
40'0" to 45'11"	1-5/8" CQ/STR	010690	—	—	010697	—	—	010700	—	—
	1-5/8" DQ/FW	010695	—	—	010698	—	—	251315	—	—
	1-7/8" DQ/FW	010696	—	—	010699	—	—	010750	—	—
46'0" to 49'11"	1-5/8" DQ/FW	010766	—	—	010769	—	—	010787	—	—
	1-7/8" DQ/FW	010768	—	—	010775	—	—	010788	—	—

* Displaying the black part number

Add the following number to the part no. for desired color:

1-Forest Green 2-Midnight Black 3-Sierra Brown

Industrial Double Swing Gates

NOTE: Without barb wire. Without hardware.

OPENING	FRAME TYPE	6'+1 HIGH			7' HIGH			7'+1 HIGH		
		GALV	SPECTRA	HEAVY MIL	GALV	SPECTRA	HEAVY MIL	GALV	SPECTRA	HEAVY MIL
Less Than 10'0"	1-5/8" Tube	010823	—	—	010815	—	—	010827	—	—
	1-5/8" CQ/STR	010824	638J1_	—	010816	638J2_	—	010828	638J3_	—
	1-5/8" DQ/FW	010825	638K3_	—	010817	638K4_	—	010829	638K5_	—
	1-7/8" DQ/FW	010826	638L5_	—	010818	638L6_	—	010830	638L7_	—
10'0" to 13'11"	1-5/8" Tube	250933	—	—	025093	—	—	251373	—	—
	1-5/8" CQ/STR	250943	638M7_	64164_	025094	638M8_	64200_	251383	638M9_	64200_
	1-5/8" DQ/FW	250953	638N9_	64165_	025095	638P0_	64201_	251393	638P1_	64201_
	1-7/8" DQ/FW	250963	638Q1_	64166_	025096	638Q2_	64202_	251403	638Q3_	64202_
14'0" to 17'11"	1-5/8" Tube	251013	—	—	025101	—	—	251453	—	—
	1-5/8" CQ/STR	251023	638R3_	64167_	025102	638R4_	64203_	251463	638R5_	64203_
	1-5/8" DQ/FW	251033	638S5_	64168_	025103	638S6_	64204_	251473	638S7_	64204_
	1-7/8" DQ/FW	251043	638T7_	64169_	025104	638T8_	64205_	251483	638T9_	64205_
18'0" to 21'11"	1-5/8" CQ/STR	251093	—	—	025109	—	—	251533	—	—
	1-5/8" DQ/FW	251103	638U9_	64170_	025110	638V0_	64206_	251543	638V1_	64206_
	1-7/8" DQ/FW	251123	638W1_	64171_	025112	638W2_	64207_	251563	638W3_	64207_
22'0" to 26'11"	1-5/8" CQ/STR	251173	—	—	025117	—	—	251613	—	—
	1-5/8" DQ/FW	251183	638X3_	64172_	025118	638X4_	64208_	251623	638X5_	64208_
	1-7/8" DQ/FW	251203	638Y5_	64173_	025120	638Y6_	64209_	251643	638Y7_	64209_
27'0" to 33'0"/33'11"	1-5/8" CQ/STR	251303	—	—	025130	—	—	251743	—	—
	1-5/8" DQ/FW	251313	638Z7_	64174_	025131	638Z8_	64210_	251753	638Z9_	64210_
	1-7/8" DQ/FW	251323	639A9_	64175_	025132	639B0_	64211_	251763	639B1_	64211_
34'0" to 39'11"	1-5/8" CQ/STR	010679	—	—	010682	—	—	251D08	—	—
	1-5/8" DQ/FW	010680	—	—	010683	—	—	010685	—	—
	1-7/8" DQ/FW	010681	—	—	010684	—	—	010686	—	—
40'0" to 45'11"	1-5/8" CQ/STR	010752	—	—	010754	—	—	010765	—	—
	1-5/8" DQ/FW	005233	—	—	010758	—	—	—	—	—
	1-7/8" DQ/FW	—	—	—	010759	—	—	007829	—	—
46'0" to 49'11"	1-5/8" DQ/FW	—	—	—	010789	—	—	010802	—	—
	1-7/8" DQ/FW	—	—	—	010790	—	—	251D25	—	—

Add the following number to the part no. for desired color:

1-Forest Green 2-Midnight Black 3-Sierra Brown

Industrial Double Swing Gates

Industrial Double Swing Gates

NOTE: Without barb wire. Without hardware.

OPENING	FRAME TYPE	8' HIGH			8'+1 HIGH			10' HIGH		
		GALV	SPECTRA	HEAVY MIL	GALV	SPECTRA	HEAVY MIL	GALV	SPECTRA	HEAVY MIL
Less Than 10'0"	1-5/8" Tube	010819	—	—	010831	—	—	025B58	—	—
	1-5/8" CQ/STR	010820	638J4_	—	—	638J5_	—	025B60	638J6_	—
	1-5/8" DQ/FW	010821	638K6_	—	010832	638K7_	—	—	638K8_	—
	1-7/8" DQ/FW	010822	638L8_	—	010833	638L9_	—	883B00	638M0_	—
10'0" to 13'11"	1-5/8" Tube	025137	—	—	010580	—	—	025B63	—	—
	1-5/8" CQ/STR	025138	638N0_	—	005729	638N1_	—	025B65	638N2_	—
	1-5/8" DQ/FW	025139	638P2_	—	251773	638P3_	—	025B67	638P4_	—
	1-7/8" DQ/FW	025140	638Q4_	—	251783	638Q5_	—	025B69	638Q6_	—
14'0" to 17'11"	1-5/8" Tube	025145	—	—	010581	—	—	025B71	—	—
	1-5/8" CQ/STR	025146	638R6_	—	007400	638R7_	—	025B73	638R8_	—
	1-5/8" DQ/FW	025147	638S8_	—	010582	638S9_	—	025B75	638T0_	—
	1-7/8" DQ/FW	025148	638U0_	—	010583	638U1_	—	025B77	638U2_	—
18'0" to 21'11"	1-5/8" CQ/STR	025153	—	—	010584	—	—	025B79	—	—
	1-5/8" DQ/FW	025154	638V2_	—	007401	638V3_	—	025B81	638V4_	—
	1-7/8" DQ/FW	025156	638W4_	—	010585	638W5_	—	007300	638W6_	—
22'0" to 26'11"	1-5/8" CQ/STR	025161	—	—	010586	—	—	025B84	—	—
	1-5/8" DQ/FW	025162	638X6_	—	010587	638X7_	—	025B86	638X8_	—
	1-7/8" DQ/FW	025164	638Y8_	—	251653	638Y9_	—	025187	638Z0_	—
27'0" to 33'0"/33'11"	1-5/8" CQ/STR	025174	—	—	010588	—	—	025B89	—	—
	1-5/8" DQ/FW	025175	639A0_	—	007403	639A1_	—	025B91	639A2_	—
	1-7/8" DQ/FW	025176	639B2_	—	010589	639B3_	—	025B93	639B4_	—
34'0" to 39'11"	1-5/8" CQ/STR	010687	—	—	010590	—	—	025B96	—	—
	1-5/8" DQ/FW	010688	—	—	010591	—	—	025B98	—	—
	1-7/8" DQ/FW	010689	—	—	251D13	—	—	025C01	—	—
40'0" to 45'11"	1-5/8" CQ/STR	010762	—	—	010592	—	—	025C03	—	—
	1-5/8" DQ/FW	010763	—	—	007402	—	—	025C05	—	—
	1-7/8" DQ/FW	010764	—	—	—	—	—	—	—	—
46'0" to 49'11"	1-5/8" DQ/FW	010799	—	—	010593	—	—	025C13	—	—
	1-7/8" DQ/FW	010800	—	—	—	—	—	025C09	—	—

Add the following number to the part no. for desired color:

1-Forest Green 2-Midnight Black 3-Sierra Brown

Industrial Double Swing Gates

NOTE: Without barb wire. Without hardware.

OPENING	FRAME TYPE	10'+1 HIGH			12' HIGH			12'+1 HIGH		
		GALV	SPECTRA	HEAVY MIL	GALV	SPECTRA	HEAVY MIL	GALV	SPECTRA	HEAVY MIL
Less Than 10'0"	1-5/8" Tube	251C69	—	—	025B59	—	—	251D30	—	—
	1-5/8" CQ/STR	251C70	638J7_	—	025B61	638J8_	—	251C71	638J9_	—
	1-5/8" DQ/FW	251C72	638K9_	—	025B62	638L0_	—	251C73	638L1_	—
	1-7/8" DQ/FW	251C74	638M1_	—	—	638M2_	—	251C75	638M3_	—
10'0" to 13'11"	1-5/8" Tube	251C76	—	—	025B64	—	—	251C77	—	—
	1-5/8" CQ/STR	251C78	638N3_	—	025B66	638N4_	—	251C79	638N5_	—
	1-5/8" DQ/FW	251C80	638P5_	—	025B68	638P6_	—	251C81	638P7_	—
	1-7/8" DQ/FW	251C82	638Q7_	—	025B70	638Q8_	—	251C83	638Q9_	—
14'0" to 17'11"	1-5/8" Tube	251C84	—	—	025B72	—	—	251C85	—	—
	1-5/8" CQ/STR	251C86	638R9_	—	025B74	638S0_	—	251C87	638S1_	—
	1-5/8" DQ/FW	251C88	638T1_	—	025B76	638T2_	—	251C89	638T3_	—
	1-7/8" DQ/FW	251C90	638U3_	—	025B78	638U4_	—	972J00	638U5_	—
18'0" to 21'11"	1-5/8" CQ/STR	251C91	—	—	025B80	—	—	251C92	—	—
	1-5/8" DQ/FW	251C93	638V5_	—	025B82	638V6_	—	251C94	638V7_	—
	1-7/8" DQ/FW	251C95	638W7_	—	025B83	638W8_	—	003337	638W9_	—
22'0" to 26'11"	1-5/8" CQ/STR	251C96	—	—	025B85	—	—	251C97	—	—
	1-5/8" DQ/FW	251C98	638X9_	—	025B87	638Y0_	—	251C99	638Y1_	—
	1-7/8" DQ/FW	007428	638Z1_	—	025B88	638Z2_	—	251D01	638Z3_	—
27'0" to 33'0"/33'11"	1-5/8" CQ/STR	251D02	—	—	025B90	—	—	251D03	—	—
	1-5/8" DQ/FW	251D04	639A3_	—	025B92	639A4_	—	251D05	639A5_	—
	1-7/8" DQ/FW	251D06	639B5_	—	025B94	639B6_	—	251D07	639B7_	—
34'0" to 39'11"	1-5/8" CQ/STR	251D09	—	—	025B97	—	—	251D10	—	—
	1-5/8" DQ/FW	251D11	—	—	025B99	—	—	251D12	—	—
	1-7/8" DQ/FW	251D14	—	—	025C02	—	—	251D15	—	—
40'0" to 45'11"	1-5/8" CQ/STR	251D16	—	—	025C04	—	—	251D17	—	—
	1-5/8" DQ/FW	251D18	—	—	025C06	—	—	251D19	—	—
	1-7/8" DQ/FW	251D20	—	—	025C07	—	—	251D21	—	—
46'0" to 49'11"	1-5/8" DQ/FW	251D28	—	—	025C08	—	—	251D23	—	—
	1-7/8" DQ/FW	251D24	—	—	025C10	—	—	251D34	—	—

Add the following number to the part no. for desired color:

1-Forest Green 2-Midnight Black 3-Sierra Brown

Chain Link - Gates



Industrial Rolling Gates

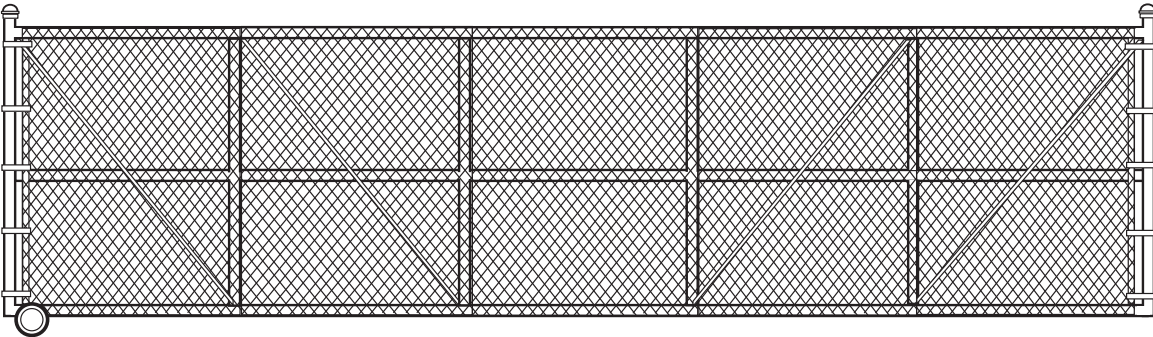
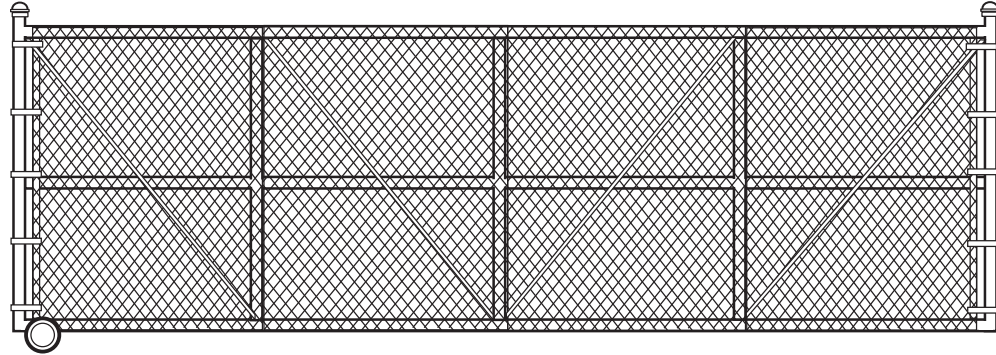
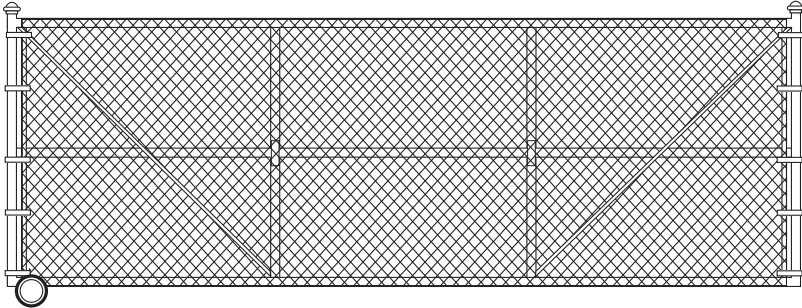
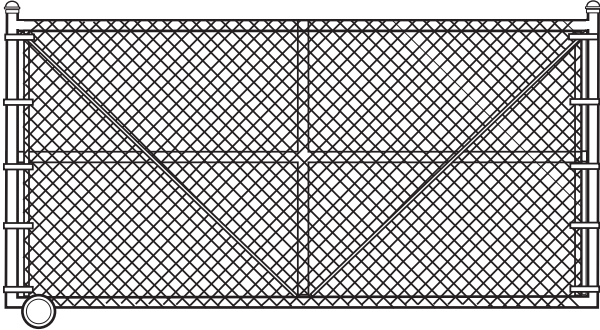

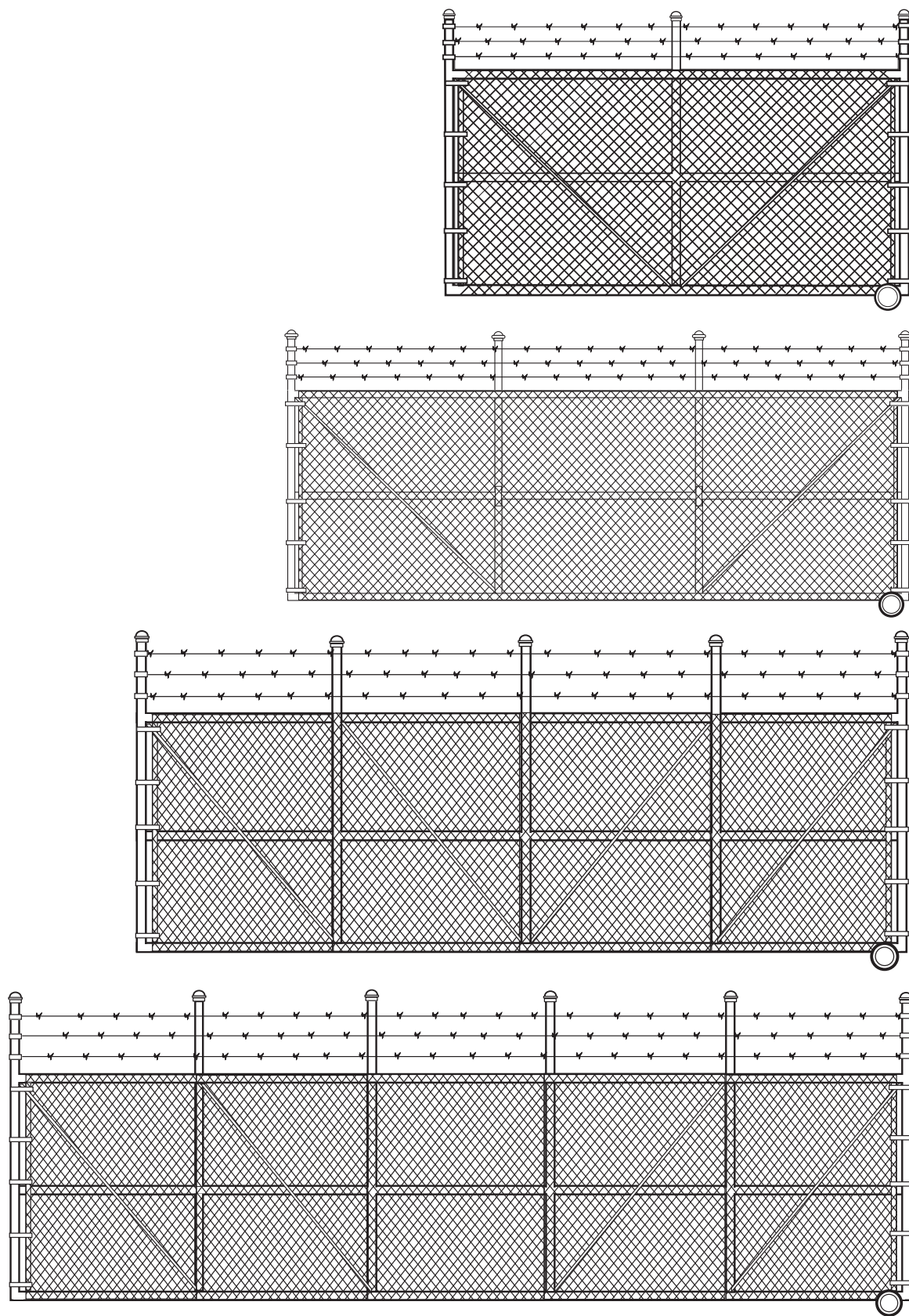

ROLL GATE SPECIFICATIONS (Industrial and Commercial)

Frame Size

Standard gates are manufactured from the pipe sizes listed. Other sizes are available on special quotation (All Industrial Gates — Non Stock).

Construction

All gates are welded corner construction. Gates include the necessary Bracing and Truss Rods. Gates are manufactured to fit the opening between posts. To allow for rear pipe track wheels, the actual gate will be 9" longer than opening. Ground clearance is 4" to allow for the ground carrier.

Fabric

Standard fabric will be 2" mesh, 9 gauge, zinc-coated steel. Other sizes and finishes are available on special quotation.

Hardware

Gates include caps only. Please refer to the Gate Fittings section for your specific hardware needs.

Barb Wire

Gate height is based on overall height of the gate, either with or without barb wire. Barb wire will be 3 strands of 12-1/2 gauge, 4 point.

Gate Posts

Gate Posts and Safety Post are sold separately. Refer to the post chart for recommended size. Maximum post spacing is 7 feet. Safety Post required.

Gate Post Recommendation

GATE HEIGHT	END POST/SAFETY POST		LINE POST	
	DQ 40	FULL WEIGHT	DQ 40	FULL WEIGHT
LESS THAN 6'	2-3/8" (3.12/FT)	2-3/8" (3.65/FT)	1-7/8" (2.28/FT)	1-7/8" (2.72/FT)
6' AND OVER	2-7/8" (4.64/FT)	2-7/8" (5.79/FT)	2-3/8" (3.12/FT)	2-3/8" (3.65/FT)

Refer to ASTM F567 for minimum requirements for setting gate posts.

Track

1-5/8" DQ 40 (1.83/ft) or Full Weight (2.27/ft). Not included. Ordered and priced separately.

Extras

For SlatMaster™ chain-link fabric, a per square foot charge will be added

Safety Note:

Safety Post required (sold separately).
Single panels greater than 30' not recommended.

Industrial Rolling Gates

NOTE: Without barb wire. Without hardware.

OPENING	FRAME TYPE	4' HIGH			5' HIGH			6' HIGH		
		GALV	SPECTRA	HEAVY MIL	GALV	SPECTRA	HEAVY MIL	GALV	SPECTRA	HEAVY MIL
10'0" to 13'11"	1-5/8" Tube	N00720	—	—	024418	—	—	024419	—	—
	1-5/8" CQ/STR	—	639C0_	—	024519	639C1_	64212_	024520	639C2_	64221_
	1-5/8" DQ/FW	—	639C8_	—	024721	639C9_	64213_	024722	639D0_	64222_
14'0" to 17'11"	1-5/8" Tube	—	—	—	024432	—	—	024433	—	—
	1-5/8" CQ/STR	—	639D6_	—	024533	639D7_	64214_	024534	639D8_	64223_
	1-5/8" DQ/FW	—	639F4_	—	024735	639F5_	64215_	024736	639F6_	64224_
18'0" to 20'11"	1-5/8" Tube	N00939	—	—	024446	—	—	024447	—	—
	1-5/8" CQ/STR	—	639G2_	—	024547	639G3_	64216_	024548	639G4_	64225_
	1-5/8" DQ/FW	—	639H0_	—	024648	639H1_	64217_	024649	639H2_	64226_
21'0" to 27'11"	1-5/8" Tube	—	—	—	024460	—	—	024461	—	—
	1-5/8" CQ/STR	—	639H8_	—	024561	639H9_	64218_	024562	639I0_	64227_
	1-5/8" DQ/FW	—	639I6_	—	024662	639I7_	64219_	024663	639I8_	64228_
28'0" to 34'0"	1-5/8" CQ/STR	—	—	—	024666	—	—	024672	—	—
	1-5/8" DQ/FW	—	639J4_	—	024668	639J5_	64220_	024674	639J6_	64229_

Add the following number to the part no. for desired color:

1-Forest Green 2-Midnight Black 3-Sierra Brown

Industrial Rolling Gates

Industrial Rolling Gates

NOTE: Without barb wire. Without hardware.

OPENING	FRAME TYPE	6'+1 HIGH			7' HIGH			7'+1' HIGH		
		GALV	SPECTRA	HEAVY MIL	GALV	SPECTRA	HEAVY MIL	GALV	SPECTRA	HEAVY MIL
10'0" to 13'11"	1-5/8" Tube	244203	—	—	024420	—	—	244213	—	—
	1-5/8" CQ/STR	245213	639C3_	64230_	024521	639C4_	64230_	245223	639C5_	64239_
	1-5/8" DQ/FW	247233	639D1_	64231_	024723	639D2_	64231_	247243	639D3_	64240_
14'0" to 17'11"	1-5/8" Tube	244343	—	—	024434	—	—	244353	—	—
	1-5/8" CQ/STR	245353	639D9_	64232_	024535	639F0_	64232_	245363	639F1_	64241_
	1-5/8" DQ/FW	247373	639F7_	64233_	024737	639F8_	64233_	247383	639F9_	64242_
18'0" to 20'11"	1-5/8" Tube	244483	—	—	024448	—	—	244493	—	—
	1-5/8" CQ/STR	245493	639G5_	64234_	024549	639G6_	64234_	245503	639G7_	64243_
	1-5/8" DQ/FW	246503	639H3_	64235_	024650	639H4_	64235_	246513	639H5_	64244_
21'0" to 27'11"	1-5/8" Tube	244623	—	—	024462	—	—	244633	—	—
	1-5/8" CQ/STR	245633	639I1_	64236_	024563	639I2_	64236_	245643	639I3_	64245_
	1-5/8" DQ/FW	246643	639I9_	64237_	024664	639J0_	64237_	246653	639J1_	64246_
28'0" to 34'0"	1-5/8" CQ/STR	246783	—	—	024678	—	—	246843	—	—
	1-5/8" DQ/FW	246803	639J7_	64238_	024680	639J8_	64238_	246863	639J9_	64247_

Add the following number to the part no. for desired color:

1-Forest Green 2-Midnight Black 3-Sierra Brown

Industrial Rolling Gates

NOTE: Without barb wire. Without hardware.

OPENING	FRAME TYPE	8' HIGH			8'+1 HIGH			NOTES
		GALV	SPECTRA	HEAVY MIL	GALV	SPECTRA	HEAVY MIL	
10'0" to 13'11"	1-5/8" Tube	024421	—	—	010839	—	—	
	1-5/8" CQ/STR	024522	639C6_	64239_	010840	639C7_	—	
	1-5/8" DQ/FW	024724	639D4_	64240_	010841	639D5_	—	
14'0" to 17'11"	1-5/8" Tube	024435	—	—	010842	—	—	
	1-5/8" CQ/STR	024536	639F2_	64241_	010846	639F3_	—	
	1-5/8" DQ/FW	024738	639G0_	64242_	010847	639G1_	—	
18'0" to 20'11"	1-5/8" Tube	024449	—	—	010848	—	—	
	1-5/8" CQ/STR	024550	639G8_	64243_	010849	639G9_	—	
	1-5/8" DQ/FW	024651	639H6_	64244_	010850	639H7_	—	
21'0" to 27'11"	1-5/8" Tube	024463	—	—	010851	—	—	
	1-5/8" CQ/STR	024564	639I4_	64245_	010852	639I5_	—	
	1-5/8" DQ/FW	024665	639J2_	64246_	010853	639J3_	—	
28'0" to 34'0"	1-5/8" CQ/STR	—	—	—	010854	—	—	
	1-5/8" DQ/FW	024686	639K0_	64247_	010855	639K1_	—	

Add the following number to the part no. for desired color:

1-Forest Green 2-Midnight Black 3-Sierra Brown

Barrier Gates

Single Swing Barrier Gates / 1-7/8" CQ Frame Only

NOTE: Without hardware.

OPENING	42" HIGH	NOTES
Less than 10'0"	015770	
10'0" to 13'11"	015771	
14'0" to 17'11"	015772	
18'0" to 20'11"	015773	
21'0" to 24'11"	015774	
25'0" to 28'11"	015775	

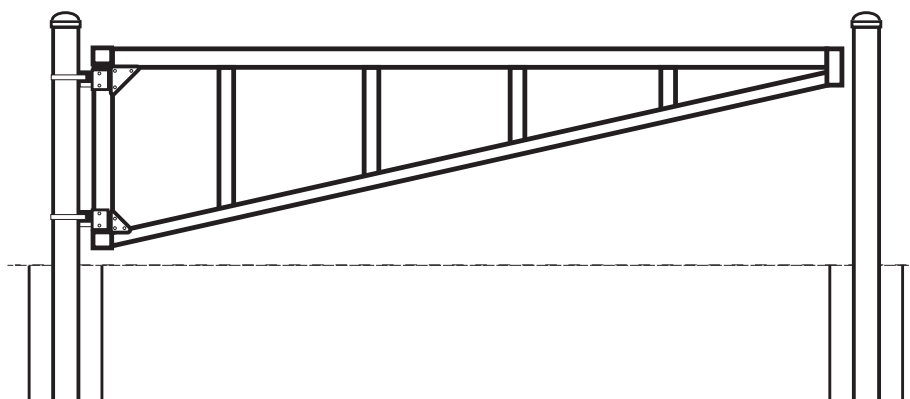

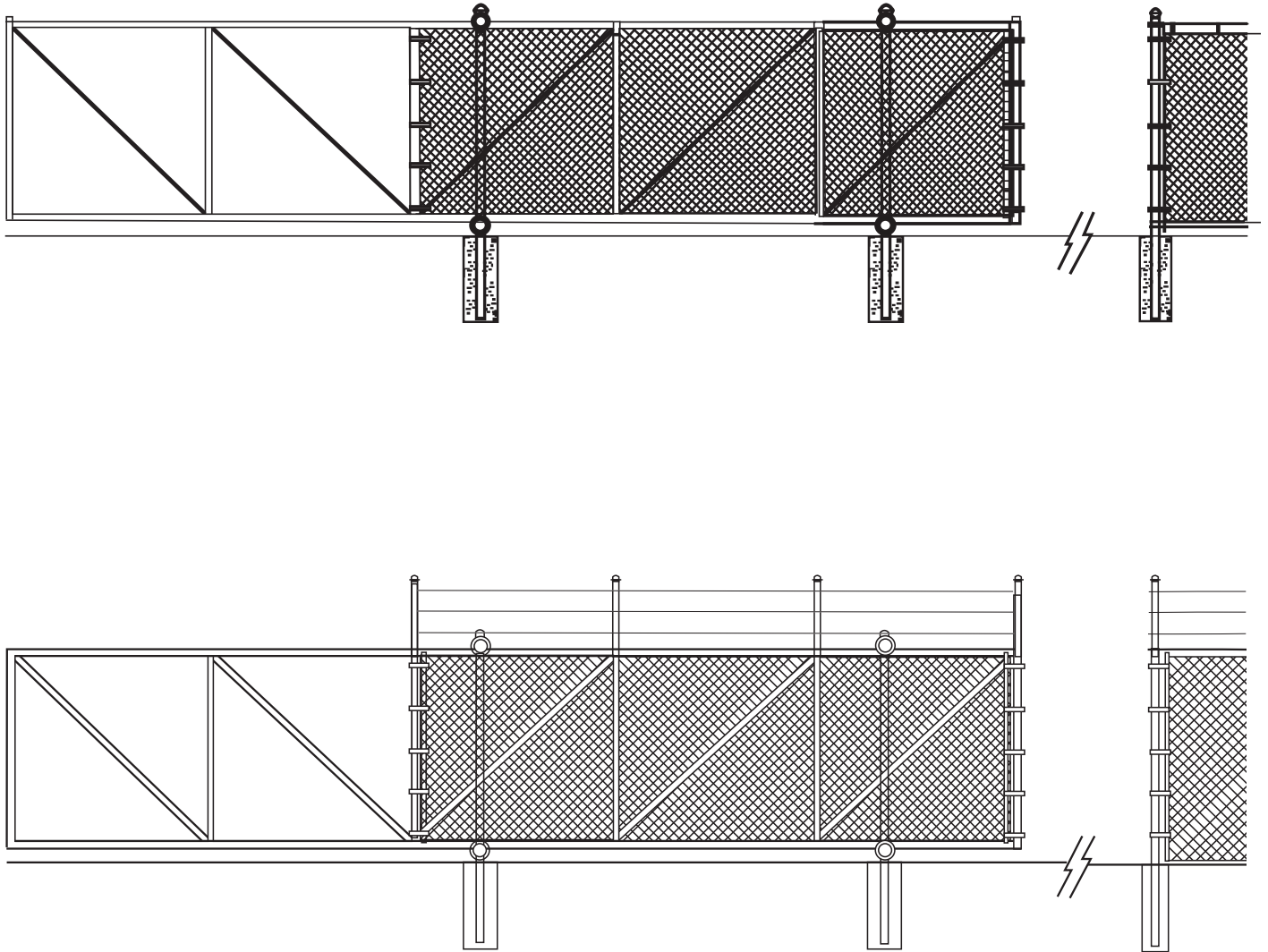

Cantilever Gates

CANTILEVER GATE SPECIFICATIONS (Industrial and Commercial)

Frame Size

Standard gates are manufactured from the pipe sizes listed. Other sizes are available on special quotation (All Cantilever Gates — Non Stock).

- Horizontal top & bottom members 2-3/8" full weight or DQ 40
- Vertical end members. 1-7/8" full weight or DQ 40
- Vertical braces. 1-7/8" full weight or DQ 40 spaced evenly but not more than 5' on centers
- Horizontal & Diagonal braces 1-5/8" structural or CQ 20

Construction

All gates are welded corner construction. Gates include the necessary bracing. Gates are manufactured to fit the opening between posts. Ground clearance is 6" to allow for bottom Cantilever Rollers.

Fabric

Standard fabric will be 2" mesh, 9 gauge, zinc-coated steel. Other sizes and finishes are available on special quotation.

Hardware

Gates include caps only. Please refer to the Gate Fittings section for your specific hardware needs.

Barb Wire

Gate height is based on overall height of the gate, either with or without barb wire. Barb wire will be 3 strands of 12-1/2 gauge, 4 point.

Gate Posts

Gate Posts and Safety Post are sold separately. Refer to post chart for recommended size. Post spacing should be 6" less than support panel length. Extend Roller posts 6" above fence line to allow for attachment of top rollers. Safety Post required.

Gate Post Recommendation

GATE OPENING WIDTH	O.D. PIPE SIZE	DQ 40 - MINIMUM WEIGHT (LB. PER FT.)	FULL WEIGHT - MINIMUM WEIGHT (LB. PER FT.)
UP TO 12'	2-7/8"	4.64	5.79
12' TO 24'	4"	6.65	9.11
24' AND OVER	6-5/8"	*	18.97

Three 4" posts may be substituted for two 6 5/8" posts.
Refer to ASTM F567 for minimum requirements for setting gate posts.

GATE OPENING WIDTH	SUPPORT PANEL LENGTH
5' THROUGH 6' 11"	SAME AS OPENING SIZE PLUS 6"
7' THROUGH 13' 11"	7' 6"
14' AND UP	1/2 THE DISTANCE OF OPENING PLUS 6"

Extras

For SlatMaster™ chain-link fabric, a per square foot charge will be added

Safety Note:

Safety Post and roller covers/guards are required (sold separately). Single panels greater than 36' not recommended.

Cantilever Gates

NOTE: Without barb wire. Without hardware.
Showing black Heavy Mil cantilever gate part numbers.

OPENING	4' HIGH			5' HIGH			6' HIGH		
	GALV	SPECTRA	HEAVY MIL	GALV	SPECTRA	HEAVY MIL	GALV	SPECTRA	HEAVY MIL
Less than 10'0"	024797	—	—	024800	639L0_	652602	024803	639L1_	652652
10'1" to 15'0"	024812	N00022*	—	024815	639M1_	652612	024818	639M2_	652662
15'1" to 20'0"	024827	—	—	024830	639N2_	652622	024833	639N3_	652672
20'1" to 25'0"	024842	N00025†	—	024845	639P3_	652632	024847	639P4_	652682
25'1" to 30'0"	024856	—	—	024859	639Q4_	652642	024862	639Q5_	652692

* Displaying the green part number
† Displaying the black part number

Cantilever Gates

NOTE: Without barb wire. Without hardware.
Showing black Heavy Mil cantilever gate part numbers.

OPENING	6'+1 HIGH			7' HIGH			7'+1' HIGH		
	GALV	SPECTRA	HEAVY MIL	GALV	SPECTRA	HEAVY MIL	GALV	SPECTRA	HEAVY MIL
Less than 10'0"	248063	639L2_	652653	024806	639L3_	652702	248093	639L4_	652703
10'1" to 15'0"	248213	639M3_	652663	024821	639M4_	652712	248243	639M5_	652713
15'1" to 20'0"	248363	639N4_	652673	024836	639N5_	652722	248393	639N6_	652723
20'1" to 25'0"	248503	639P5_	652683	024850	639P6_	652732	248533	639P7_	652733
25'1" to 30'0"	248653	639Q6_	652693	024865	639Q7_	652742	248683	639Q8_	652743

Add the following number to the part no. for desired color:

1-Forest Green 2-Midnight Black 3-Sierra Brown

Cantilever Gates

Cantilever Gates

NOTE: Without barb wire. Without hardware.
Showing black Heavy Mil cantilever gate part numbers.

OPENING	8' HIGH			8'+1 HIGH			10' HIGH		
	GALV	SPECTRA	HEAVY MIL	GALV	SPECTRA	HEAVY MIL	GALV	SPECTRA	HEAVY MIL
Less than 10'0"	024809	639L5_	652752	010834	639L6_	652753	024C50	639L7_	—
10'1" to 15'0"	024824	639M6_	652762	010836	639M7_	652763	024C54	639M8_	—
15'1" to 20'0"	024839	639N7_	652772	010837	639N8_	652773	024C58	639N9_	—
20'1" to 25'0"	024853	639P8_	652782	024840	639P9_	652783	024C62	639Q0_	—
25'1" to 30'0"	024868	639Q9_	652792	010838	639R0_	652793	024C66	639R1_	—

Cantilever Gates

NOTE: Without barb wire. Without hardware.

OPENING	10'+1 HIGH			12' HIGH			12'+1 HIGH		
	GALV	SPECTRA	HEAVY MIL	GALV	SPECTRA	HEAVY MIL	GALV	SPECTRA	HEAVY MIL
Less than 10'0"	024C51	639L8_	—	024C52	639L9_	—	024C53	639M0_	—
10'1" to 15'0"	024C55	639M9_	—	024C56	639N0_	—	024C57	639N1_	—
15'1" to 20'0"	024C59	639P0_	—	024C60	639P1_	—	024C61	639P2_	—
20'1" to 25'0"	024C63	639Q1_	—	024C64	639Q2_	—	024C65	639Q3_	—
25'1" to 30'0"	024C67	639R2_	—	024C68	639R3_	—	024C69	639R4_	—

Add the following number to the part no. for desired color:

1-Forest Green 2-Midnight Black 3-Sierra Brown

SURTRAC™ ALUMINUM CANTILEVER GATE SPECIFICATIONS

Frame Size

Standard gates are manufactured from square aluminum members conforming to ASTM B 221, Alloy and Temper 6061-T6.

- Single Track Top Track Rail 2-3/4" x 4-3/4" rectangular aluminum weight 4.62/ft.
- Dual Track Top Track Rail 2-3/4" x 9" rectangular aluminum weight 7.95/ft.
- Horizontal bottom member 2" x 4" aluminum weight 1.73/ft, 0.25" thickness.
- Gate Frame 2" square aluminum weight 1.12/ft, 0.25" thickness.
- Vertical Interior Bracing 2" square aluminum weight 1.12/ft. spaced evenly but not more than 6' on centers.

Single Track

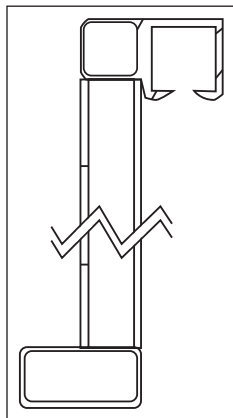

Single Gates
up to 30'

Double Gates
up to 60'

Dual Track

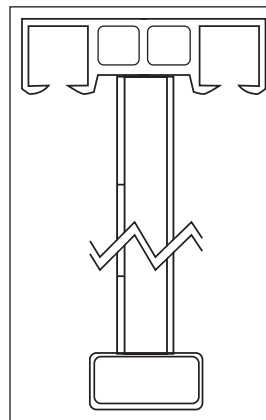

Single Gates
from 30'1" to 50'

Double Gates
up to 100'

Construction

All gates are welded corner construction. Gates include the necessary bracing. Gates are manufactured to fit the opening between posts. Ground clearance is 4".

Fabric

Standard fabric will be 2" mesh, 9 gauge galvanized/aluminized (aluminum-coated steel). Other sizes and finishes are available on special quotation.

Hardware

4", 6-5/8", and 8-5/8" hardware is available, ordered separately.

Barb Wire

Barb wire will be 3 strands of aluminized 12-1/2 gauge, 4 point.

Posts

Gate Posts and Safety Post are sold separately. Refer to post chart for recommended size. Post spacing should be 6" less than support panel length. Extend Roller posts 6" above fence line to allow for attachment of top rollers. Safety Post required for Single Track gates.

For any gate where Support Posts are greater than 10' apart, a line post must be installed, centered between the two Support Posts that is supported on each side with top rail and cross trussed to Support Posts.

Single Gates - Post Recommendation

GATE OPENING WIDTH	SUPPORT POST QTY.	LATCH POST QTY.	SAFETY POST QTY.	LINE POST QTY.	O.D. PIPE SIZE	DQ 40 OR FW PIPE
UP TO 20'	2	1	1	0	4"	ASTM F 1043 ASTM F 1083
20' TO 31'	2	1	1	1	4"	ASTM F 1043 ASTM F 1083
31' AND OVER	4	1	0	1	4"	ASTM F 1043 ASTM F 1083

Refer to ASTM F567 for minimum requirements for setting gate posts.

Aluminum Cantilever Gates

Single Track SurTrac Aluminum Cantilever Gates

NOTE: Without barb wire. Without hardware.

OPENING	TAIL LENGTH	OVERALL GATE LENGTH	6' HIGH		6'+1 HIGH		7' HIGH	
			GALV	SPECTRA	GALV	SPECTRA	GALV	SPECTRA
10'	4'	14'	059110	06004_	059131	06022_	059152	06043_
12'	5'	17'	059111	06005_	059132	06023_	059153	06044_
14'	6'	20'	059112	06006_	059133	06024_	059154	06045_
16'	7'	23'	059113	06001_	059134	06025_	059155	06046_
18'	8'	26'	059114	06002_	059135	06026_	059156	06047_
20'	8'	28'	059115	06003_	059136	06027_	059157	06048_
22'	9'	31'	059116	06007_	059137	06028_	059158	06049_
24'	10'	34'	059117	06008_	059138	06029_	059159	06050_
26'	11'	37'	059118	06009_	059139	06030_	059160	06051_
28'	12'	40'	059119	06010_	059140	06031_	059161	06052_
30'	12'	42'	059120	06011_	059141	06032_	059162	06053_

OPENING	TAIL LENGTH	OVERALL GATE LENGTH	7'+1 HIGH		8' HIGH		8'+1 HIGH	
			GALV	SPECTRA	GALV	SPECTRA	GALV	SPECTRA
10'	4'	14'	059174	06064_	059196	06085_	059238	06106_
12'	5'	17'	059175	06065_	059197	06086_	059239	06107_
14'	6'	20'	059176	06066_	059198	06087_	059246	06108_
16'	7'	23'	059177	06067_	059199	06088_	059247	06109_
18'	8'	26'	059178	06068_	059201	06089_	059248	06110_
20'	8'	28'	059179	06069_	059202	06090_	059249	06111_
22'	9'	31'	059181	06070_	059203	06091_	059251	06112_
24'	10'	34'	059182	06071_	059204	06092_	059252	06113_
26'	11'	37'	059183	06072_	059211	06093_	059253	06114_
28'	12'	40'	059184	06073_	059212	06094_	059254	06115_
30'	12'	42'	059185	06074_	059213	06095_	059256	06116_

Hardware Kits / For Single Track SurTrac Aluminum Cantilever Gates

DESCRIPTION	FOR SINGLE GATES		FOR DOUBLE GATES		NOTES
	GALV	BLACK	GALV	BLACK	
4" Single Track Hardware Kit	009099	012439	009105	012472	
6-5/8" Single Track Hardware Kit	009100	012440	009106	012473	
8-5/8" Single Track Hardware Kit	009101	012441	009107	012474	

Add the following number to the part no. for desired color:

1-Forest Green 2-Midnight Black 3-Sierra Brown

Dual Track SurTrac Aluminum Cantilever Gates

NOTE: Without barb wire. Without hardware.

OPENING	TAIL LENGTH	OVERALL PANEL LENGTH	6' HIGH		6'+1 HIGH		7' HIGH	
			GALV	SPECTRA	GALV	SPECTRA	GALV	SPECTRA
32'	13'	45'	059121	06012_	059142	06033_	059163	06054_
34'	14'	48'	059122	06013_	059143	06034_	059164	06055_
36'	15'	51'	059123	06014_	059144	06035_	059165	06056_
38'	16'	54'	059124	06015_	059145	06036_	059166	06057_
40'	16'	56'	059125	06016_	059146	06037_	059167	06058_
42'	17'	59'	059126	06017_	059147	06038_	059168	06059_
44'	18'	62'	059127	06018_	059148	06039_	059169	06060_
46'	19'	65'	059128	06019_	059149	06040_	059170	06061_
48'	20'	68'	059129	06020_	059150	06041_	059171	06062_
50'	20'	70'	059130	06021_	059151	06042_	059172	06063_

OPENING	TAIL LENGTH	OVERALL PANEL LENGTH	7'+1 HIGH		8' HIGH		8'+1 HIGH	
			GALV	SPECTRA	GALV	SPECTRA	GALV	SPECTRA
32'	13'	45'	059186	06075_	059214	06096_	059257	06117_
34'	14'	48'	059187	06076_	059217	06097_	059258	06118_
36'	15'	51'	059188	06077_	059218	06098_	059259	06119_
38'	16'	54'	059189	06078_	059219	06099_	059261	06120_
40'	16'	56'	059190	06079_	059231	06100_	059262	06121_
42'	17'	59'	059191	06080_	059232	06101_	059263	06122_
44'	18'	62'	059192	06081_	059233	06102_	059264	06123_
46'	19'	65'	059193	06082_	059234	06103_	059266	06124_
48'	20'	68'	059194	06083_	059236	06104_	059267	06125_
50'	20'	70'	059195	06084_	059237	06105_	059268	06126_

Hardware Kits / For Dual Track SurTrac Aluminum Cantilever Gates

DESCRIPTION	FOR SINGLE GATES		FOR DOUBLE GATES		NOTES
	GALV	BLACK	GALV	BLACK	
4" Single Track Hardware Kit	009102	012442	009108	012475	
6-5/8" Single Track Hardware Kit	009103	012443	009109	012476	
8-5/8" Single Track Hardware Kit	009104	012443	009112	012477	

Add the following number to the part no. for desired color:

1-Forest Green 2-Midnight Black 3-Sierra Brown

Aluminum Cantilever Gates

Reversible SurTrac Aluminum Cantilever Gates

NOTE: Without hardware.

FEATURES:

- Standard Size gates that can be hung on right or left side and still maintain perfect balance
- Barb Wire Arm kits can be added for additional security (Barb wire sold separately)
- On the ground availability for immediate replacement when accidents occur
- Ideal for high security and high volume applications
- 5 year warranty on the Gate System

6' HIGH

OPENING	TAIL LENGTH	OVERALL PANEL LENGTH	GALV	BLACK	NOTES
20'	8'	28'	734C00	011484	
24'	10'	34'	735C00	011486	
30'	12'	42'	736C00	011485	

Hardware Kits / For Reversible SurTrac Aluminum Cantilever Gates

DESCRIPTION	GALV	BLACK	NOTES
4" Single Track Hardware Kit	009099	012439	
Barb Arm Kit for 20' and 24' Opening	342Y00	011726	
Barb Arm Kit for 30' Opening	009148	011727	

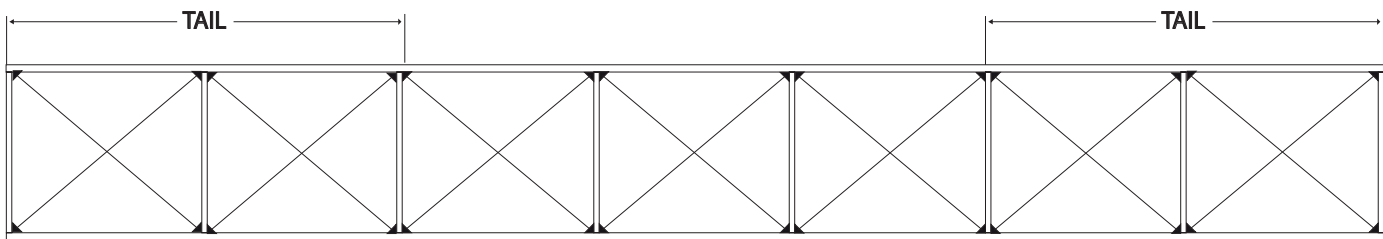

Hardware Kit Components / For Single Track and Dual Track SurTrac Aluminum Cantilever Gates

DESCRIPTION	GALV	BLACK	NOTES
Truck Assembly 5/8" Bolt	987L00	—	
4" Cantilever Latch with U-Bolt	433M00	012392	
4" Truck Bracket with U-Bolt	989L00	012390	
4" Bottom Guide Roller with U-Bolt	168M00	012391	
6-5/8" Truck Bracket with U-Bolt	171M00	012394	
6-5/8" Bottom Guide Roller with U-Bolt	170M00	012395	
8-5/8" Truck Bracket with U-Bolt	172M00	012396	
8-5/8" Bottom Guide Roller with U-Bolt	173M00	012397	

Stabilizer Brace / For Single Track and Dual Track SurTrac Aluminum Cantilever Gates

NOTE Use with:

- SurTrac gates installed with a gate opener
- Manual SurTrac gates with an opening greater than 24'
- SurTrac gates in high wind areas

DESCRIPTION	GALV	NOTES
2" x 4" Stabilizer Brace Bolt-on (sold by foot of opening)	429U00	

NOTES

NOTES

NOTES

NOTES

NOTES

NOTES

NOTES