

OUTDOOR SUPER GATE

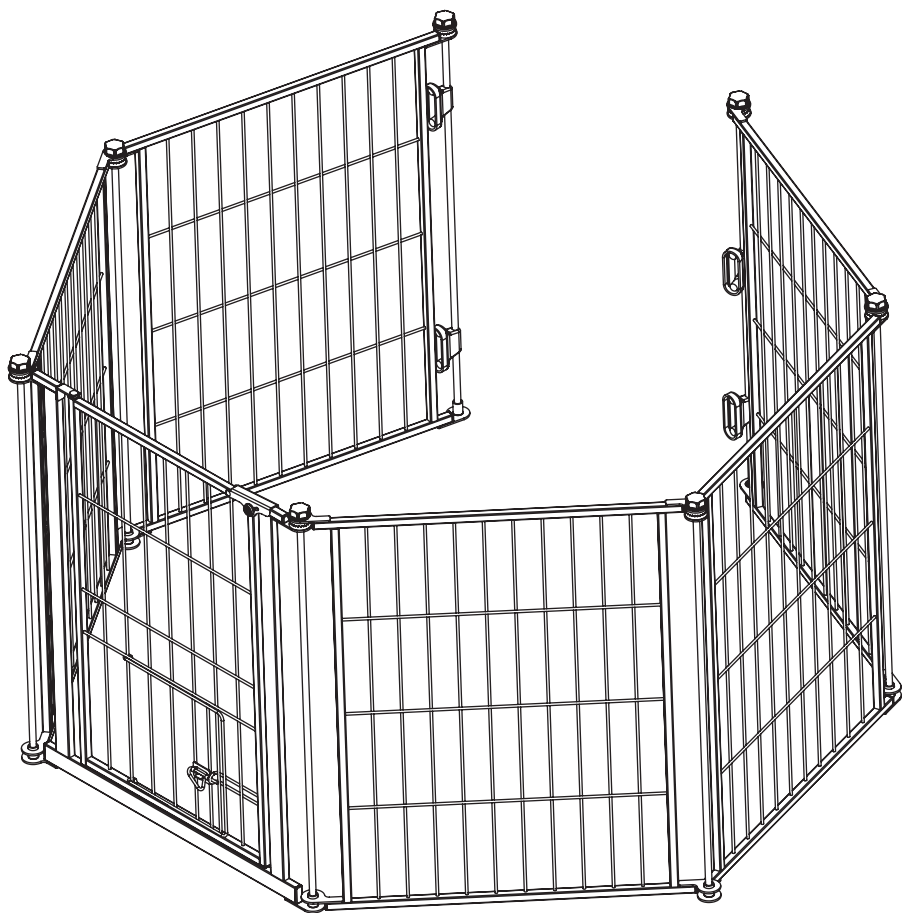

- READ ALL INSTRUCTIONS BEFORE ASSEMBLY AND USE OF GATE.
- KEEP INSTRUCTIONS FOR FUTURE USE.

 www.carlsonpetproducts.com

 Carlson Pet Products, Inc.
3200 Corporate Center Drive, Suite 105 | Burnsville, MN 55306, USA

 952.435.1084

Made in China

Before Using Product

Read and follow all instructions carefully to ensure that your gate and extensions are properly installed. Improper installation could result in the gate becoming unstable or dislodged from the doorway. Always make sure the extension is securely attached to the gate before using. Please keep these instructions for your reference.

IMPORTANT

- The four mounting brackets must be used in securing the gate to the wall. These brackets prevent the gate from dislodging from its opening and becoming unstable.
- If hardware mounting to a surface other than drywall or wood, please consult with a professional about installation.



WARNING

- To prevent serious injury or death, securely install gate or enclosure and use according to manufacturer's instructions.
- Check the gate regularly to see if all the hardware and mountings are tightened.
- This is a Pet Gate. NOT intended for use with children.
- This is a pet gate, but when used with children the small pet door must remain closed and securely latched.
- Strangulation hazard: pets can force themselves into very small openings; use this gate with pets whose heads will not fit into openings in the gate, between the gate and floor, or between the gate and wall.
- Never use with pet able to climb over or dislodge/open the gate or enclosure.
- Never leave pet unattended.
- Use only with the locking/latching mechanism securely engaged.
- To prevent falls, NEVER use at the top of stairs.
- This gate is designed to fit maximum width openings 144 inches.

Before Assembly

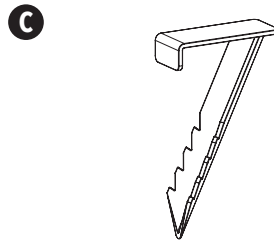
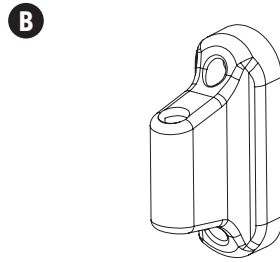
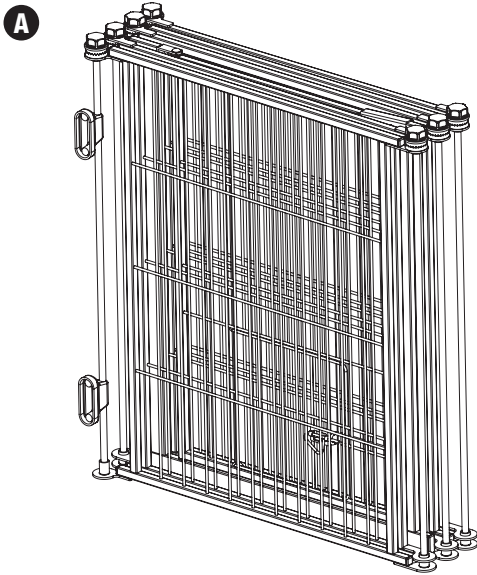

PLEASE CHECK TO MAKE SURE YOU HAVE THE FOLLOWING PARTS:

- A** *Super Gate Frame Assembly (6 Panels)*
- B** *Wall Mounting Bracket (4 - Attached to Gate Frame)*
- C** *Outdoor Ground Stakes (4)*

Option A: Installing Your Gate Between Two Walls

STEP 1

Unfold the *super gate frame* by turning the *locking knobs* counter clockwise at each pivoting joint. Loosen the knobs enough to allow the individual panels to swing open freely without fully removing the knobs.

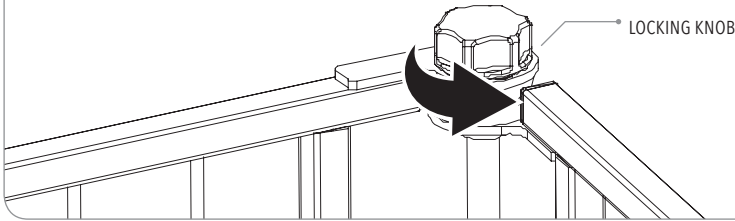

STEP 2

Configure your *super gate* into your desired shape. The gate should rest directly on the floor.

STEP 3

Use a Phillips/cross-head screwdriver to fix the *wall mounting bracket* to the wall. Repeat for all four brackets.

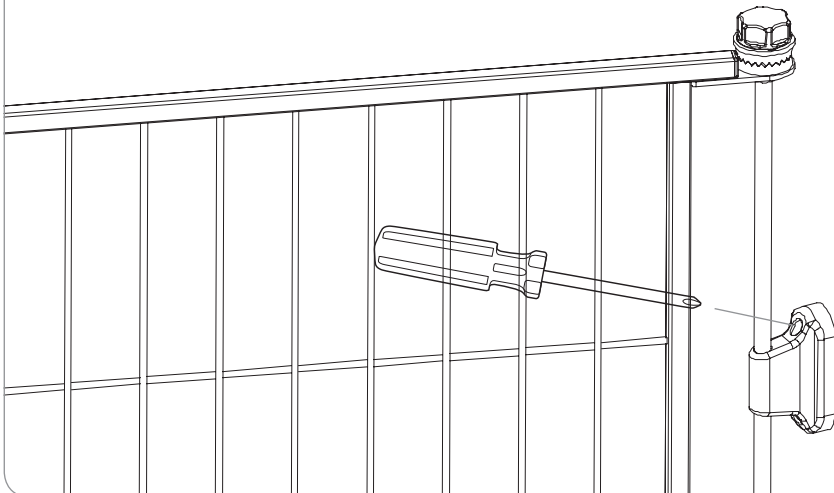

Option B: Installing Your Gate as a Freestanding Enclosure

STEP 1

Unfold the *super gate frame* by turning the *locking knobs* counter clockwise at each pivoting joint. Loosen the knobs enough to allow the gate to swing open freely without fully removing the knobs.

STEP 2

Configure your super gate into your desired shape. The gate should rest directly on the floor.

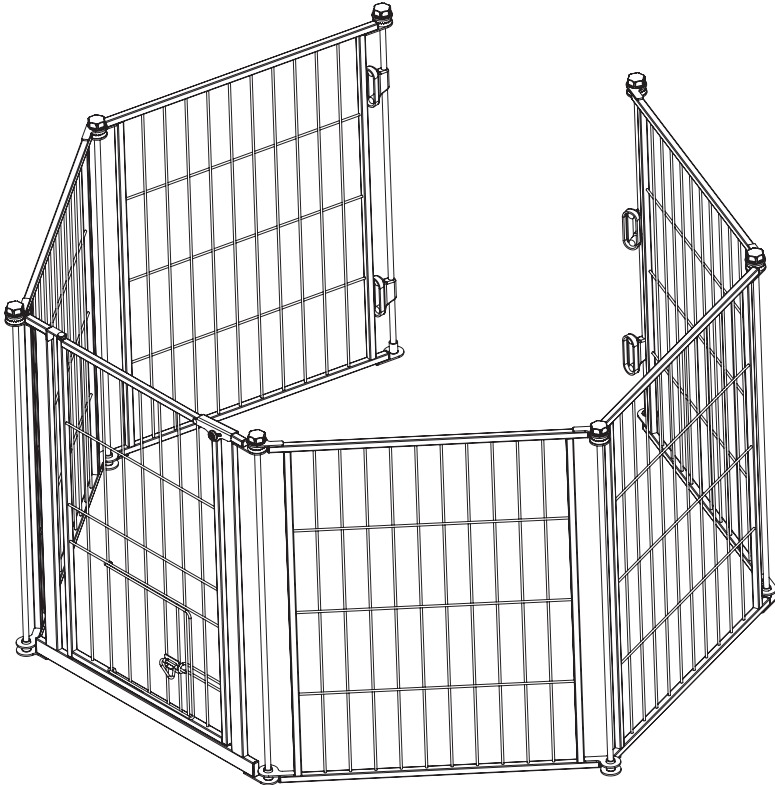

STEP 3

Unscrew and remove the (2) *locking knobs* at each end of the gate. Then, remove the *vertical metal pivot bars* (2), the *mounting brackets* (4) and the associated *toothed disks* and *metal receiving cup*. All components on each end of the gate that can be removed without the use of tools should now be removed.

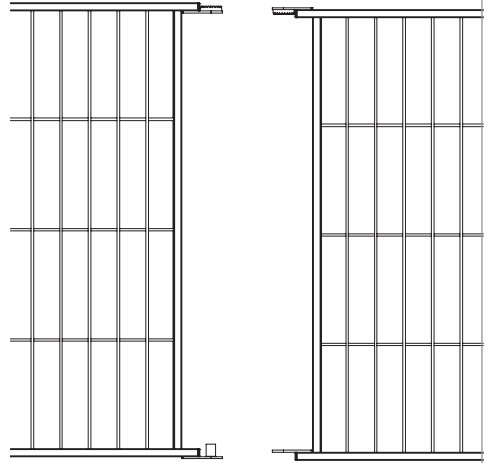

STEP 4

Join the free ends of the gate together to form a closed structure. Insert one of the previously removed *metal pivot bars* through the opening created by joining the *upper metal joints*. Guide the *metal pivot bar* downward into the circular housing on the *lower metal joint*.

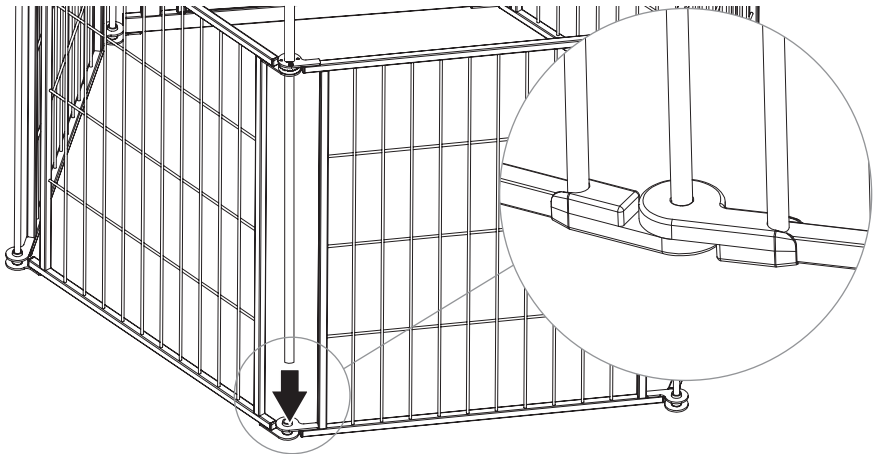

STEP 5

Use one of the *locking knobs* you removed in STEP 3 to join the two panels together. Once you are satisfied with the configuration of your *pet yard*, go back and tighten all of the *locking knobs*. To position the *pet yard* into a new configuration or shape, loosen each of the *locking knobs*, adjust and re-tighten.

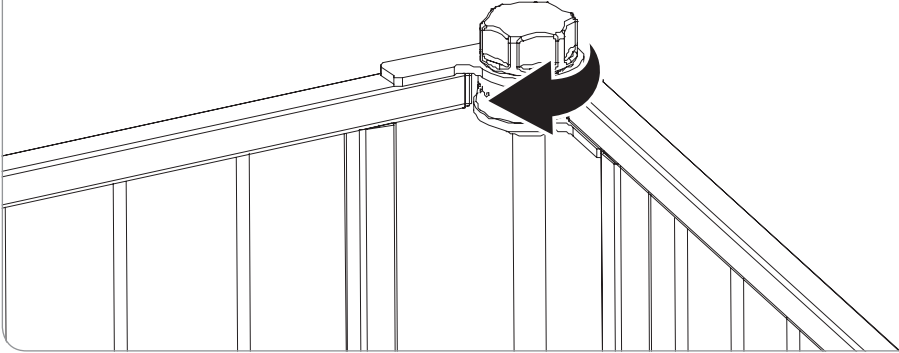

NOTE: When adding or removing additional panel units to the configuration, panels must be added or subtracted in sets of two for the freestanding enclosure to function properly.

NOTE: When using the *super gate* over grass, secure the bottom rail with *ground stakes* for added stability.

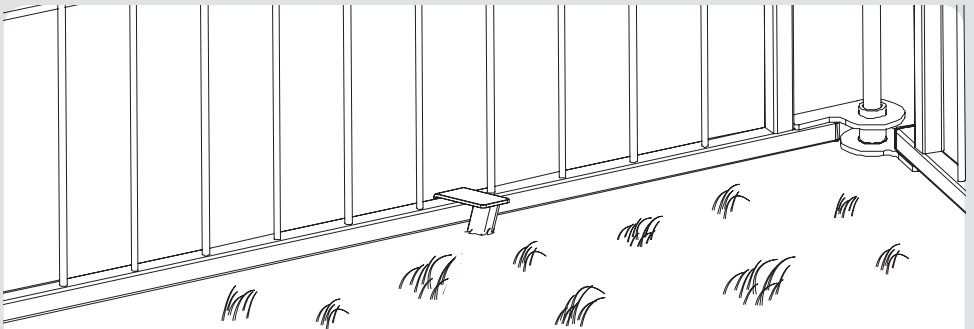

TO FOLD YOUR SUPER GATE

STEP 1: Loosen all of the *locking knobs* so the panels can move freely and become flexible at the joints.

STEP 2: Remove one of the *locking knobs* from the super gate and remove one vertical tube.

STEP 3: You will now be able to pull the two *metal joints* and the top and bottom of the super gate apart.

STEP 4: Fold and put away.

CARE AND MAINTENANCE

Periodically check the gate for signs of damage, wear, or missing components. Do not use if any part is missing, worn or damaged. Check the gate regularly to ensure all the hardware and mountings are tightened. Do not use abrasive cleaners or bleach. Clean by sponging with warm water and a mild detergent.

90 DAYS LIMITED WARRANTY

If, during the first 90 days after consumer purchase of the item, under reasonable and non-commercial use and conditions of maintenance, it fails while owned by the original purchaser because of the quality of materials or workmanship of finish and assembly, Carlson Pet Products, Inc. will replace or repair it at Carlson's option. PROOF OF PURCHASE REQUIRED.

Replacement Parts

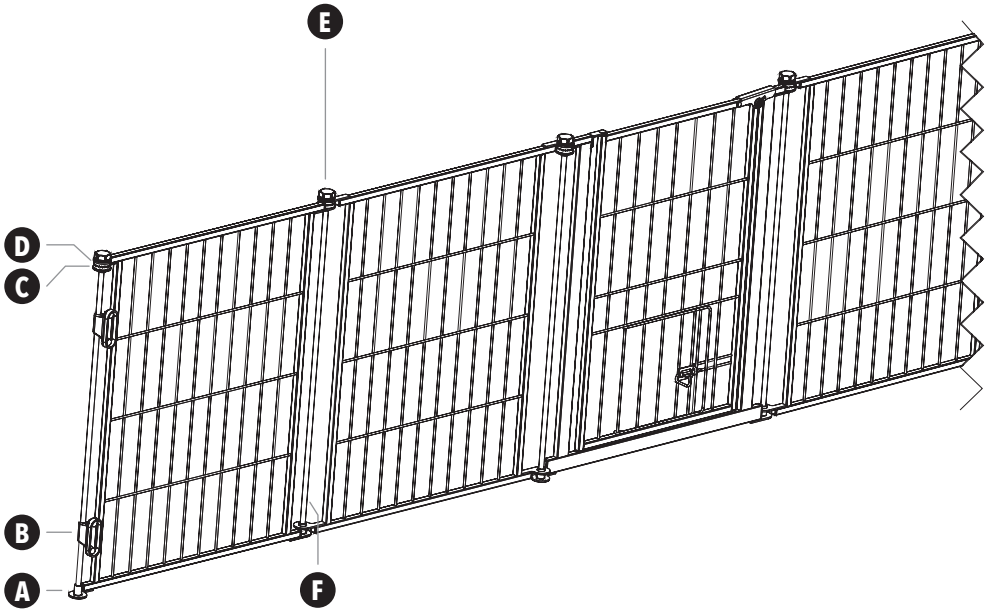

A **Metal Receiving Cup**
Black = #11130



E **Outdoor Locking Knob**
Black = #11135

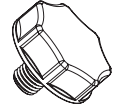

B **Wall Mount Bracket**
Black = #11007

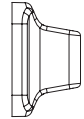

F **Metal Pivot Bar**
35.5" = #11132
27.5" = #11131



C **Outdoor Lower Toothed Disc**
Black = #11133

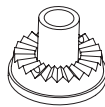

G **1" Wall Mount Screws**
#10001



D **Outdoor Upper Toothed Disc**
Black = #11134





www.carlsonpetproducts.com



Carlson Pet Products, Inc.
3200 Corporate Center Drive, Suite 105
Burnsville, MN 55306, USA



952.435.1084