



Bale Blind

Model MGB6000

Please read and follow all instructions and warnings. Failure to follow these instructions may result in serious injury or death!

- ⚠ WARNING!** This product is not fireproof. The fabric will burn if it comes into contact with an open flame or fuel source. Keep product away from direct flame. Failure to follow this warning may result in serious injury or death!
- ⚠ WARNING!** This product is for hunting purposes only! It is not to be used as a camping tent or for any other function. Failure to follow this warning may result in serious injury or death!
- ⚠ WARNING!** Do not use devices that produce fumes inside of blind. Vapors and fumes could result in carbon monoxide poisoning, serious injury, or death!
- ⚠ WARNING!** Do not allow children or adults to use lighted candles, matches, or other sources of fire near this product. Failure to follow this warning may result in serious injury or death!
- ⚠ WARNING!** Do not allow the material to cover your face. This may result in serious injury, suffocation, or death!
- ⚠ WARNING!** Do not allow children to use this product without direct adult supervision. Failure to follow this warning may result in serious injury or death!

PARTS LIST

Part #	Description	Qty
UP15-0096	End Frame Base - Male Piece	2
UP15-0097	End Frame Base - Female Piece	2
UP15-0098	End Frame Hoop	8
UP15-0099	Side Support	8
UP15-0100	End Support - Male Piece	4
UP15-0101	End Support - Female Piece	4
UP15-0102	Waterfowl Door	1
UP15-0103	Waterfowl Door Extension	1
UP15-0104	Waterfowl Door Latch	1
UP15-0105	Cross Support	4
UP15-0372	Lower Cross Support	8
UP15-0106	Anchor Stakes	4
UP15-0107	Blind Cover	1
UP15-0108	Window Cover	6
UP15-0109	Peek Window Cover	3
UP15-0110	Side Window Bungee - 48"	4
UP15-0111	End Window Bungee - 30"	2
UP15-0112	End Window Bungee - 60"	2





Note: Hardware is not listed for pre-assembled Waterfowl Door Hinges.

Check to make sure you have all the required parts and hardware. If you find damaged or missing parts in a newly purchased product, please return this product to the retailer for replacement.

TIPS FOR INCREASING PRODUCT LONGEVITY

Always store your blind in a cool dry place and make sure that your blind is completely dry and clean before storing in carrying bag. Never leave your blind outside for any longer than needed. This material may fade after long periods of time in direct sunlight.

HARDWARE LIST

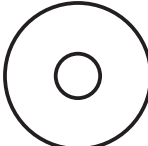
Part #	Description	Qty
UP77-0156	[A] 5mm X 1" Hex Bolt	75
		
UP77-0173	[B] 5mm x 1 1/4" Hex Bolt	12
		
UP77-0157	[C] 5mm x 1 1/2" Hex Bolt	2
		
UP77-0097	5mm Nylock Nut	89
		
UP77-0002	Nylon Washer	1
		

⚠ WARNING! ⚠
Read all instructions and safety warnings and follow them thoroughly. Failure to follow these instructions may result in serious injury or death!

ATTENTION!! WHEN YOU SEE A "⚠ WARNING!" BE SURE TO HEED THE MESSAGE! THE INFORMATION CONTAINED IN THESE MESSAGES CAN SAVE YOUR LIFE!!

⚠ WARNING! DO NOT over tighten the hardware. Over tightening can lead to structural damage and may negatively affect the performance of your blind. Failure to follow these instructions may result in serious injury or death!

NOTE: All Steps require that you temporarily finger tighten all nuts and bolts until instructed to tighten. This will ensure proper alignment during assembly. Most parts of this model are manufactured to be universal in use, so there may be some parts containing holes that will not be used for assembly. To minimize confusion in the assembly process, please read these instructions in entirety before beginning.

STEP 1. Attach the (2) **end frame base male pieces** to the (2) **end frame base female pieces** using (2) 5mm x 1" hex bolts [A] and (2) 5mm nylock nuts. **Note:** Only one shown here.

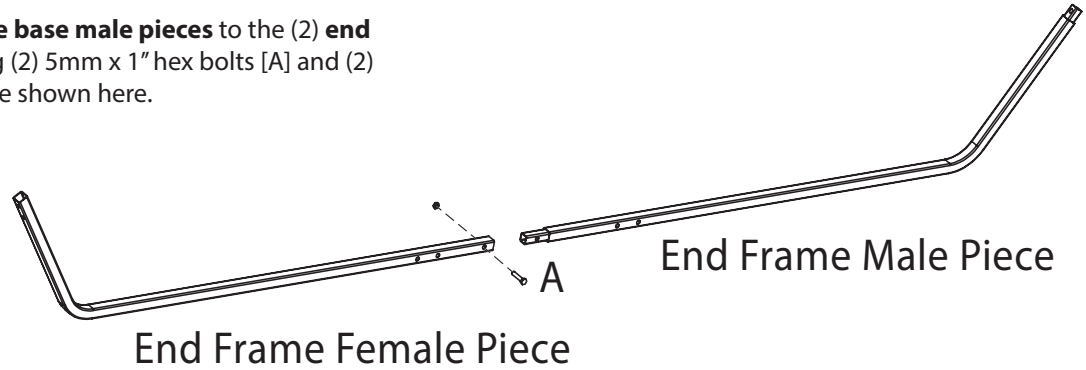

STEP 2. Complete each end frame by connecting (4) **end frame hoops** to each assembled **end frame base**. **Note:** Only one shown here.

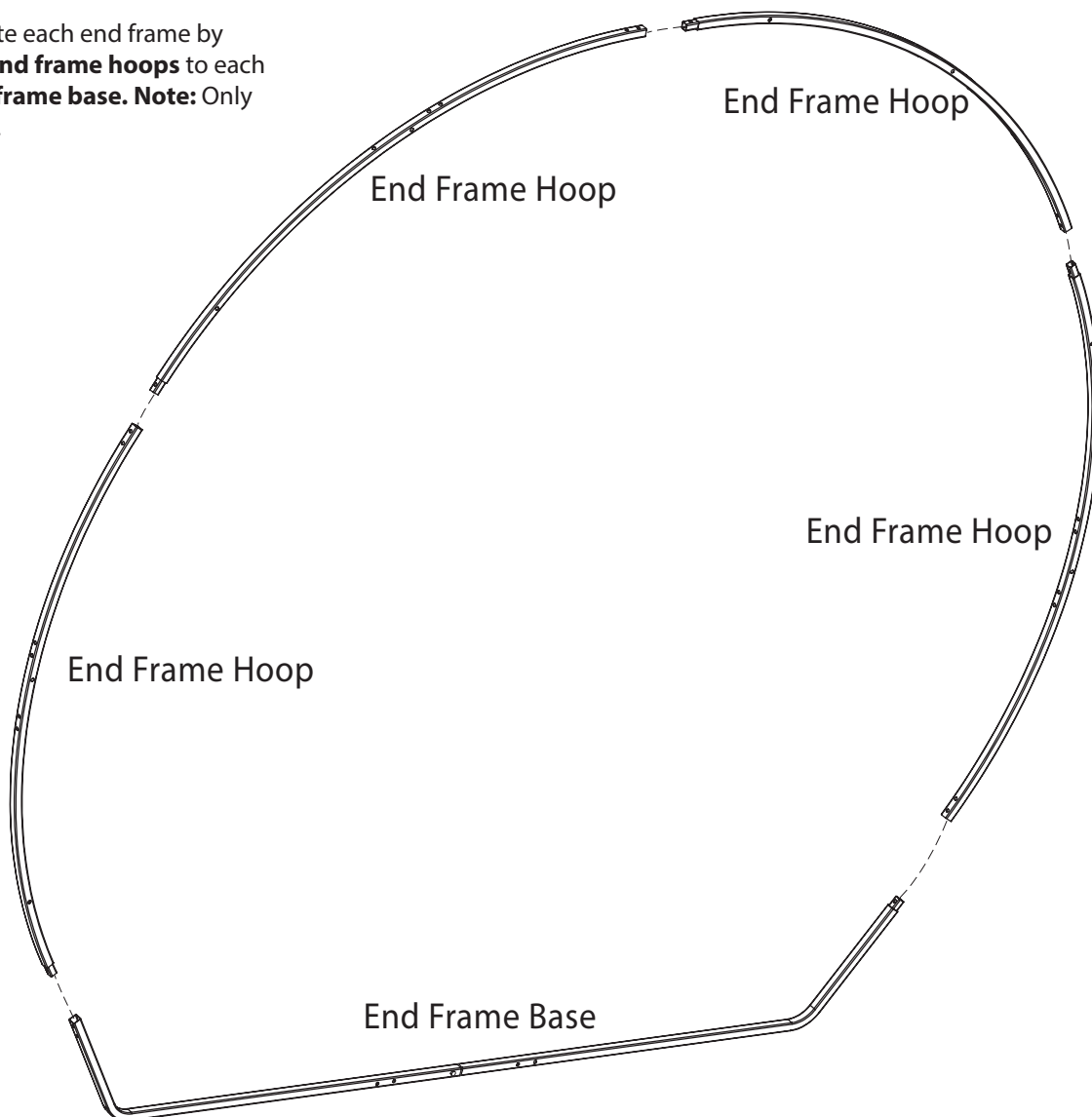

ATTENTION!! WHEN YOU SEE A "⚠ WARNING!" BE SURE TO HEED THE MESSAGE! THE INFORMATION CONTAINED IN THESE MESSAGES CAN SAVE YOUR LIFE!!

STEP 3. Using (16) 5mm x 1" hex bolts [A] and (16) 5mm nylock nuts, attach (4) **side supports** to the outside of the assembled **end frames** in the illustrated locations. **NOTE:** For proper assembly the assembled end frames **MUST** mirror each other.

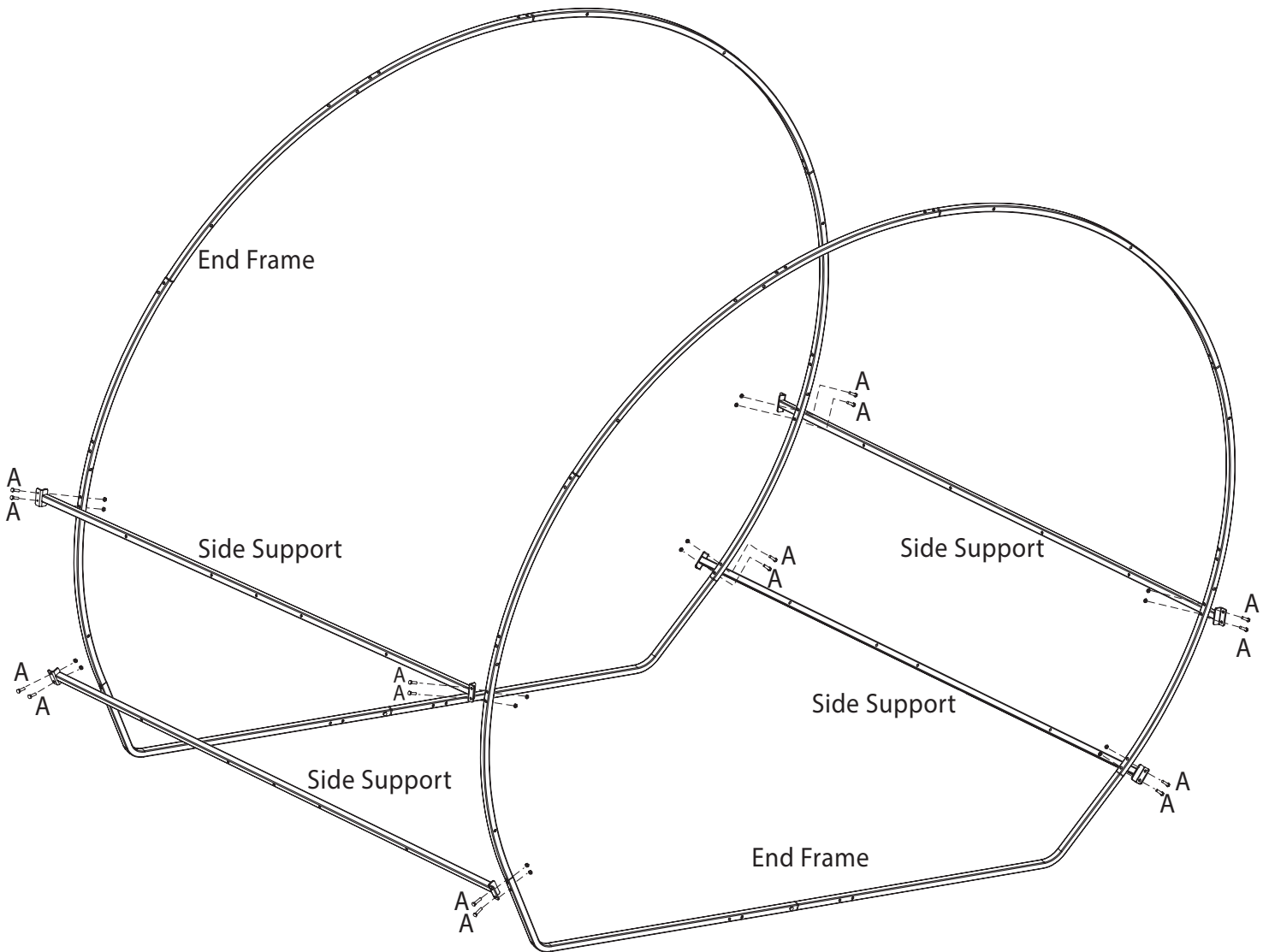

READ THIS MANUAL IN ITS ENTIRETY PRIOR TO USING THIS PRODUCT.

**ATTENTION!! WHEN YOU SEE A "⚠ WARNING!" BE SURE TO HEED THE MESSAGE!
THE INFORMATION CONTAINED IN THESE MESSAGES CAN SAVE YOUR LIFE!!**

STEP 4. Next, attach the (4) remaining **side supports** to the outside of the assembled **end frames** in the illustrated locations using (16) 5mm x 1" hex bolts [A] and (16) 5mm nylock nuts to secure.

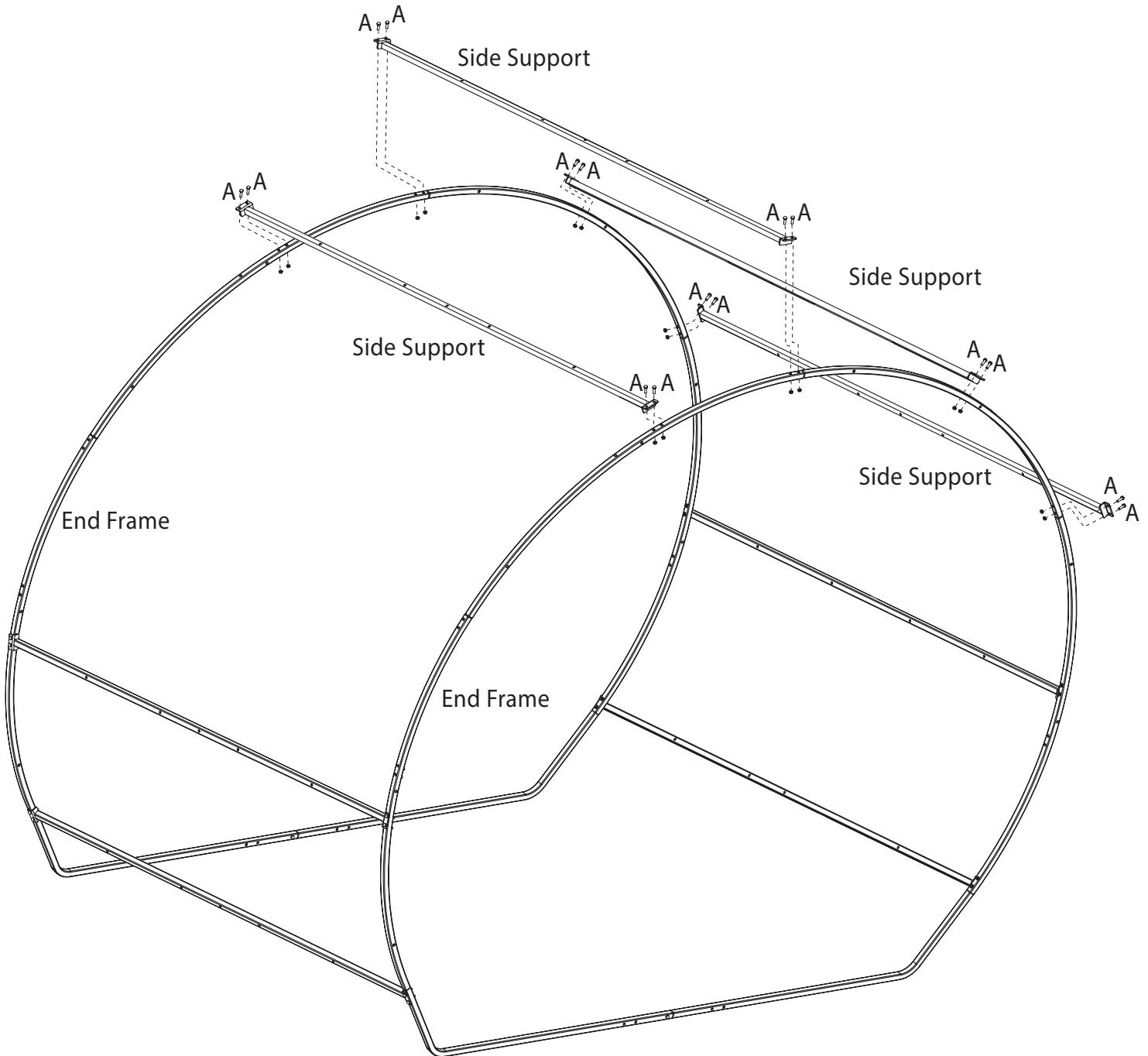

ATTENTION!! WHEN YOU SEE A "⚠ WARNING!" BE SURE TO HEED THE MESSAGE! THE INFORMATION CONTAINED IN THESE MESSAGES CAN SAVE YOUR LIFE!!

STEP 5. Connect the **waterfowl door extension** to the pre-assembled **waterfowl door** using (2) 5mm x 1 1/2" hex bolts [C] and (2) 5mm nylock nuts.

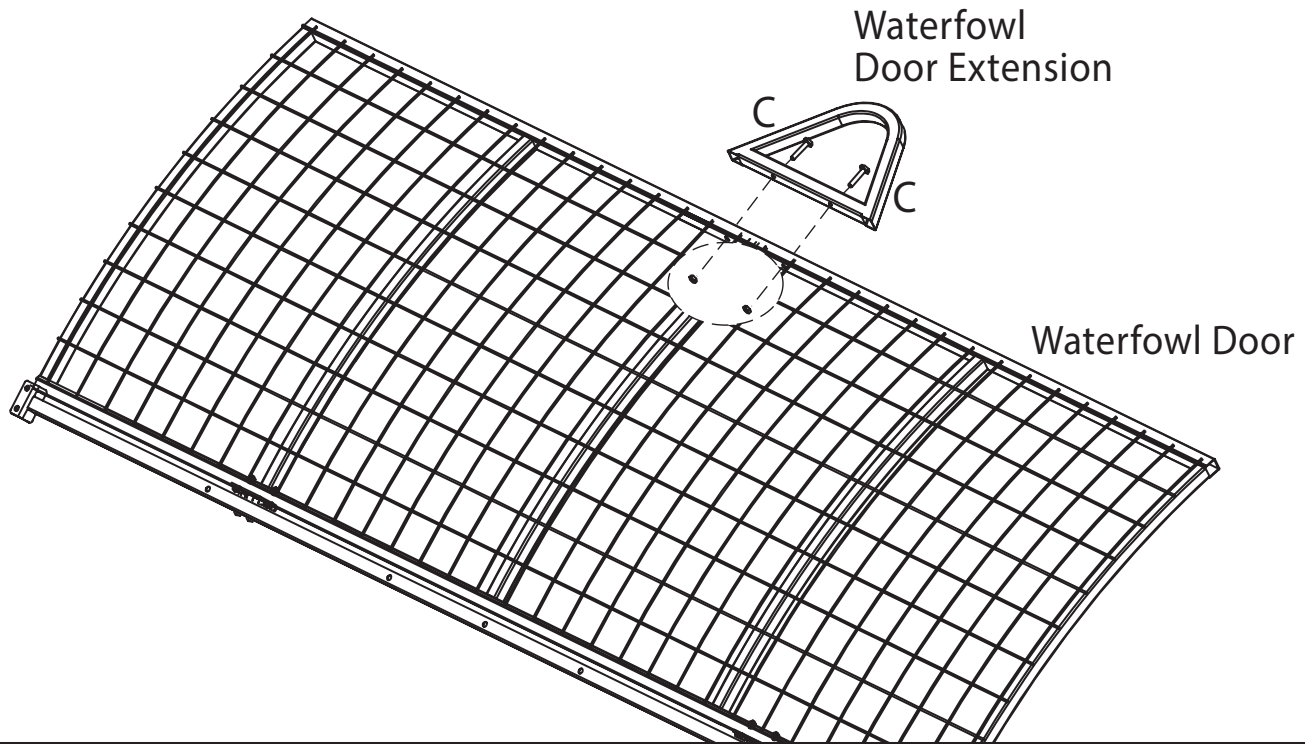

STEP 6. Using (4) 5mm x 1" hex bolts [A] and (4) 5mm nylock nuts, attach the assembled **waterfowl door** to the outside of the assembled **end frames** in the illustrated locations.

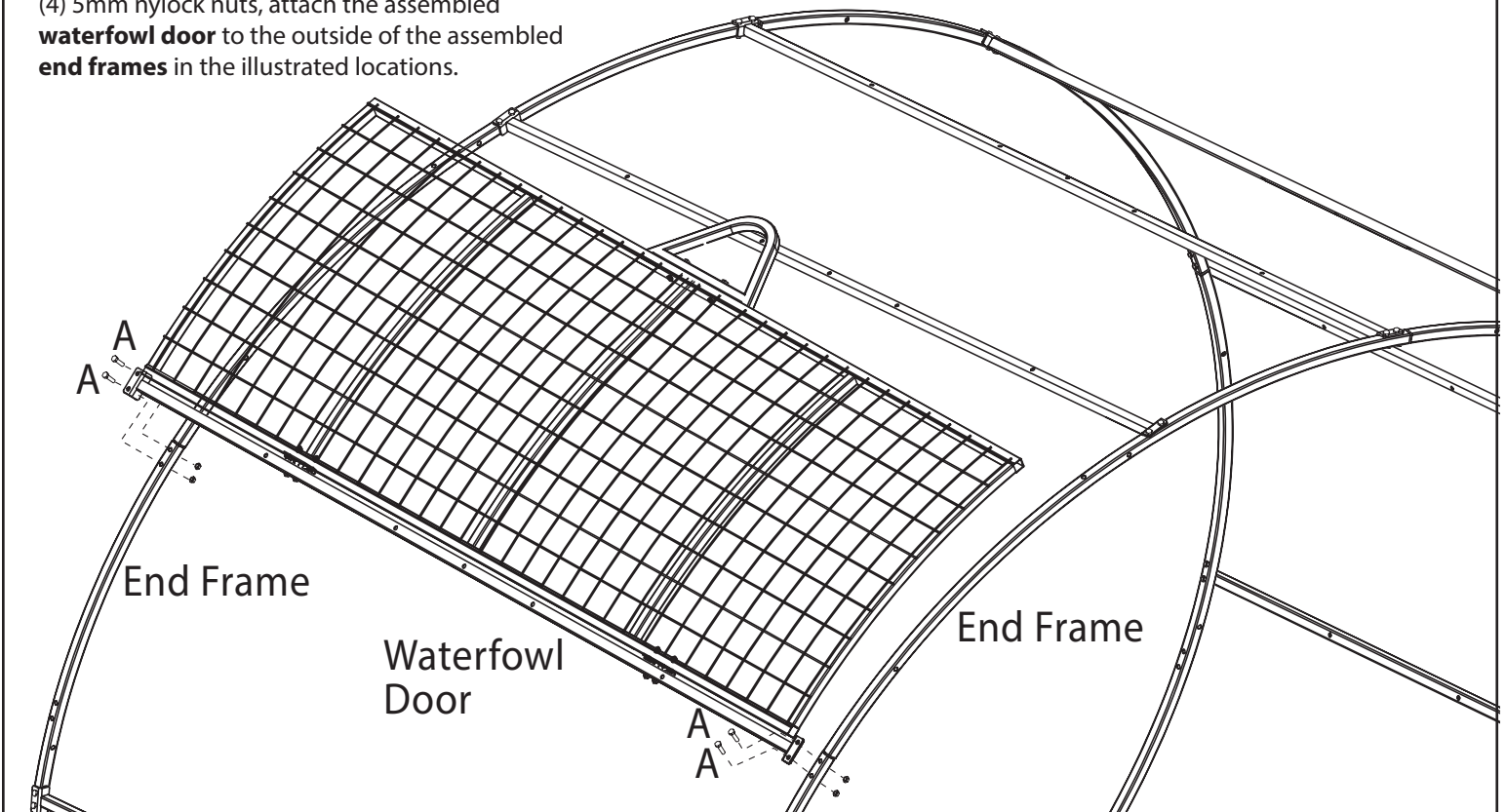

READ THIS MANUAL IN ITS ENTIRETY PRIOR TO USING THIS PRODUCT.

ATTENTION!! WHEN YOU SEE A "⚠ WARNING!" BE SURE TO HEED THE MESSAGE! THE INFORMATION CONTAINED IN THESE MESSAGES CAN SAVE YOUR LIFE!!

STEP 7. Attach the (4) **end support male pieces** to the (4) **end support female pieces** using (4) 5mm x 1" hex bolts [A] and (4) 5mm nylock nuts.

STEP 8. Next, secure the assembled **end supports** to the illustrated locations on the **end frames** using (8) 5mm x 1 1/4" hex bolts [B] and (8) 5mm nylock nuts.

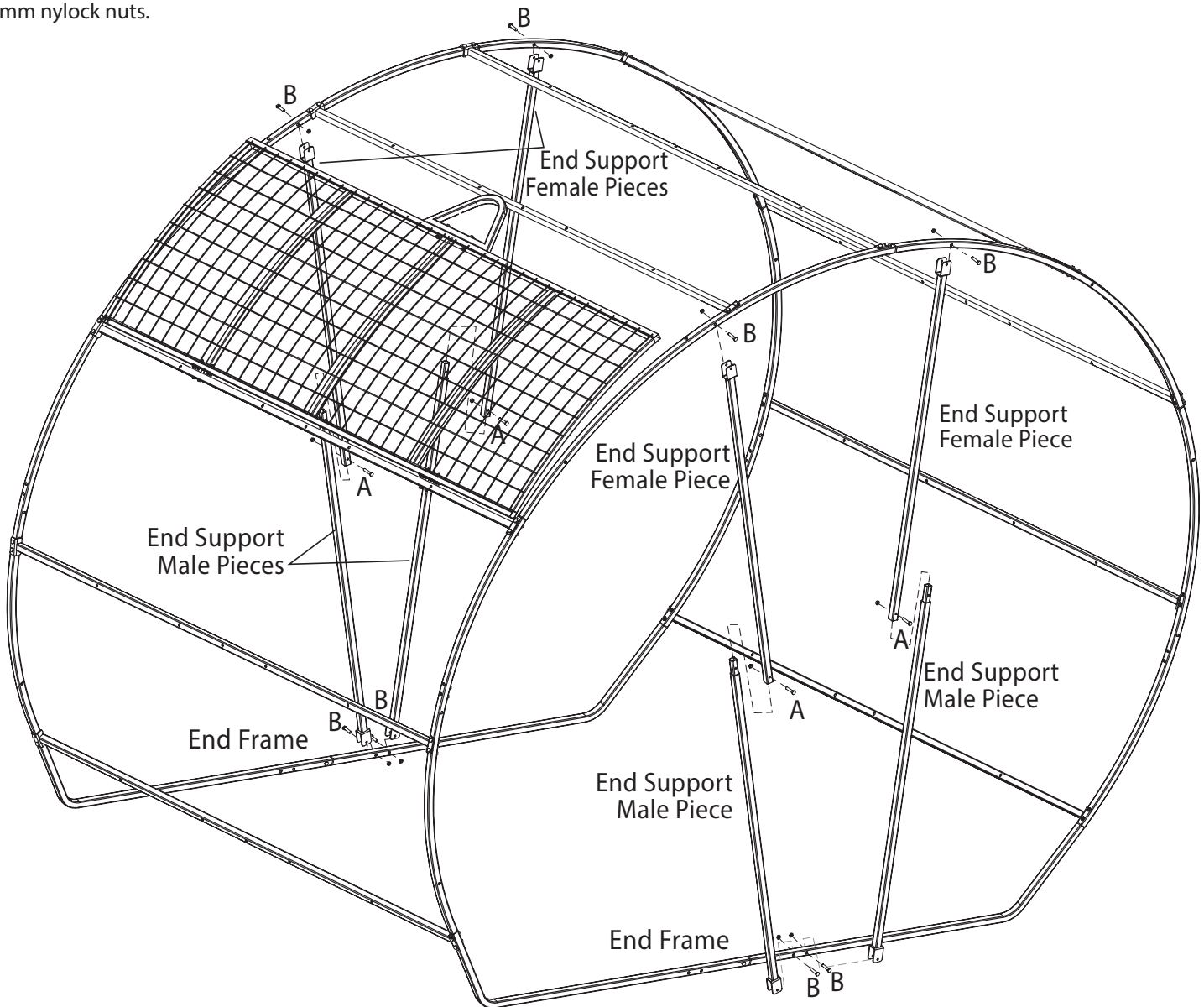

STEP 9. Using (12) 5mm x 1" hex bolts [A] and (12) 5mm nylock nuts, attach the **cross supports** to the outer holes on the top three **side supports**.

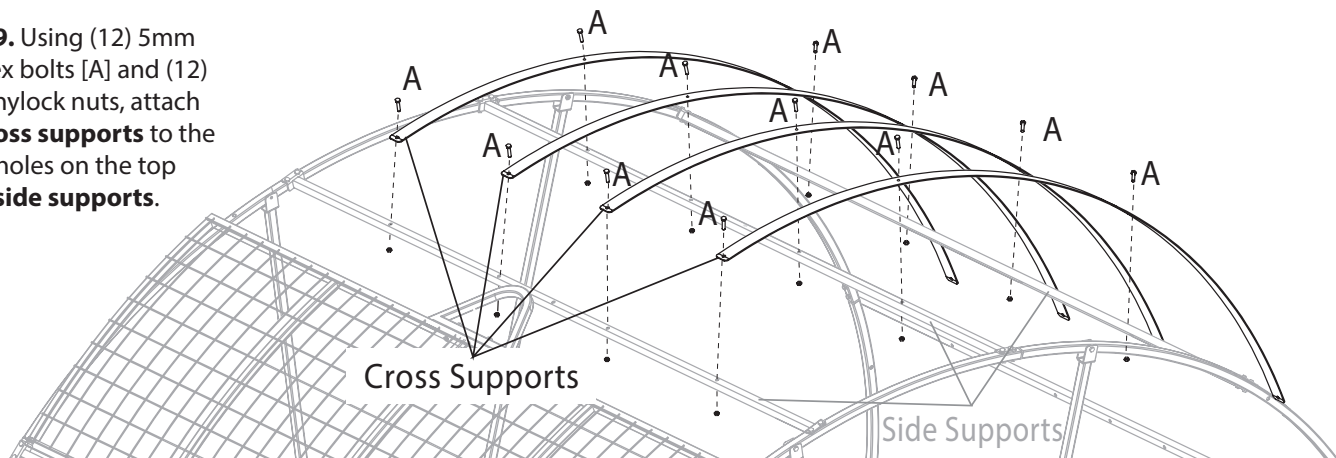

ATTENTION!! WHEN YOU SEE A "⚠ WARNING!" BE SURE TO HEED THE MESSAGE! THE INFORMATION CONTAINED IN THESE MESSAGES CAN SAVE YOUR LIFE!!

STEP 10. Attach (4) **lower cross supports** to the remaining **cross support assembly holes** using (4) 5mm x 1 1/4" hex bolts [B] and (4) 5mm nylock nuts to secure. Then, finish connecting these (4) **lower cross supports** to the **side supports** using (8) 5mm x 1" hex bolts [A] and (8) 5mm nylock nuts.

STEP 11. Secure the remaining **lower cross supports** to the outer holes on the three **side supports** below the waterfowl door using (12) 5mm x 1" hex bolts [A] and (12) 5mm nylock nuts.

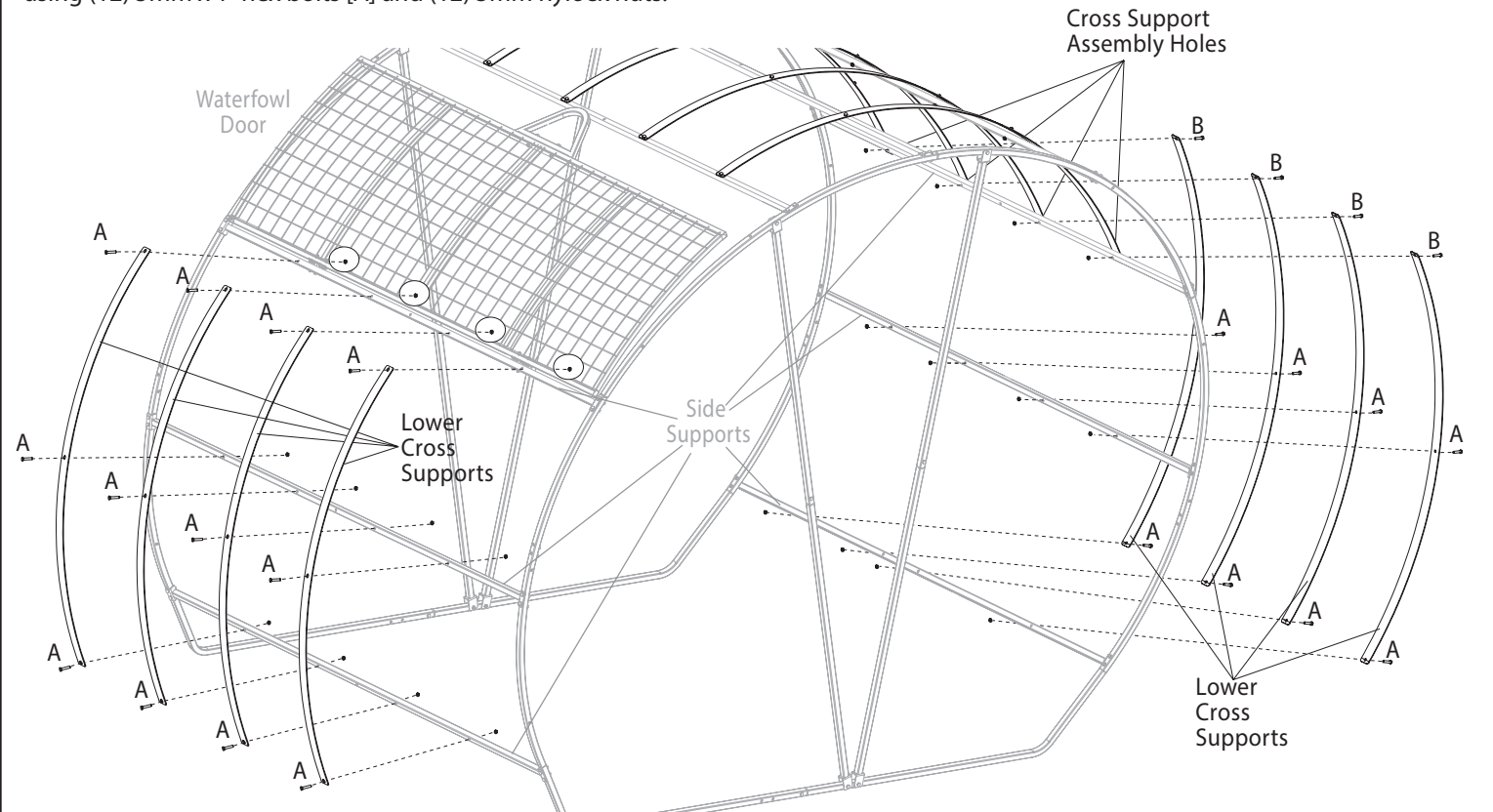

STEP 12. Using (1) 5mm x 1" hex bolt [A], (1) nylon washer and (1) 5mm nylock nut attach the **waterfowl door latch** to the center hole on the **side support** above the waterfowl door.

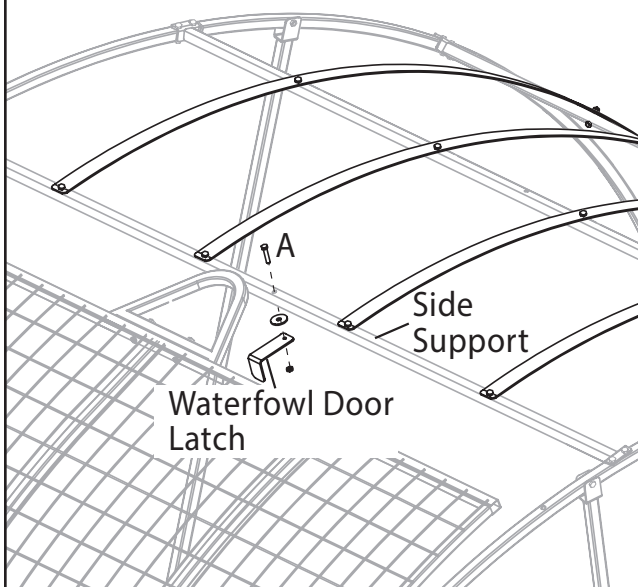

STEP 13. SECURELY TIGHTEN ALL NUTS AND BOLTS AT THIS TIME.

STEP 14. Ensuring the zippered corners are open, carefully pull the fabric cover over the assembled frame noting the waterfowl door opening is on the same side as the waterfowl door. Align and secure the fabric cover on the assembled frame using inner ties and zippered corners.

STEP 15. Secure the pre-assembled windows between the fabric cover and the assembled frame using bungee hooks.

Anchoring the bale blind: (4) anchor stakes are included to secure your bale blind to the ground. The (4) anchor stakes are to be placed in the corners of the interior of the blind as illustrated.

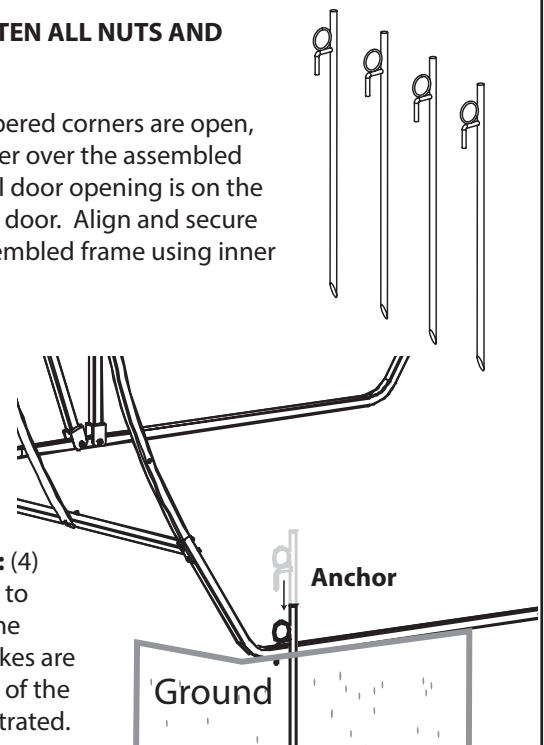

READ THIS MANUAL IN ITS ENTIRETY PRIOR TO USING THIS PRODUCT.



PO Box 454 • Windom, MN 56101
(844) 745-7723

www.GoMuddy.com