

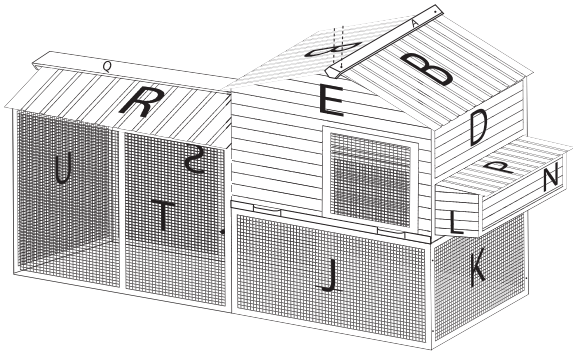

Raised Wooden Chicken Coop #112
Assembly Instructions













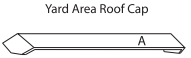
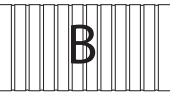
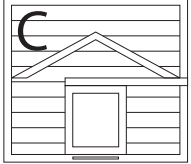
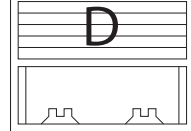
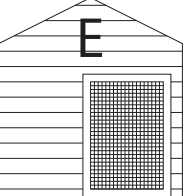
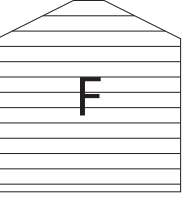
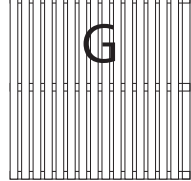

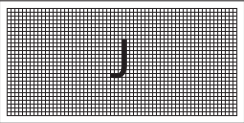
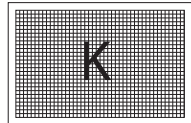
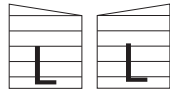

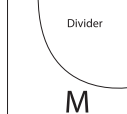

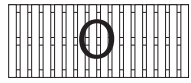
Important notes:

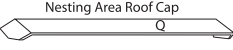
Lay out all components prior to start of assembly.

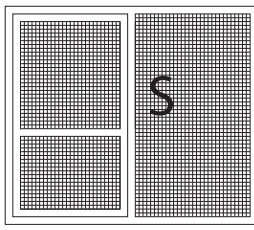
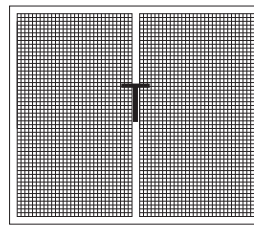
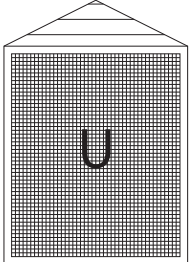
Flat level surface recommended for assembly.

If any components are missing or damaged, do not return to retailer! Please call Rugged Ranch Products at: 760-734-3748

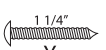
Please visit our website to see our complete line of Rugged Ranch Products. www.ruggedranch.net

 <p>Yard Area Roof Cap A</p>	 <p>Living Area Roof B</p> <p>2 Pieces</p>	 <p>Inside Yard Entry C</p>	 <p>Inside Roost Bar Slot Panel D</p>	 <p>Nesting Area Front E</p>
 <p>Nesting Area Back F</p> <p>2 Pieces</p>	 <p>Living Area Tray G</p>	 <p>Pull Out Tray H</p>	 <p>Perch</p>	
 <p>Front/Back Yard Panel J</p> <p>2 Pieces</p>	 <p>Side Yard Panel K</p>	 <p>Nest Box Front Panel L</p>  <p>Nest Box Back Panel L</p>	 <p>Divider M</p>	 <p>Sliding Door</p>
 <p>Nest Box Side Panel N</p>	 <p>Nest Box Tray O</p>	 <p>Nesting Area Roof P</p>	 <p>Nesting Area Roof Cap Q</p>	 <p>Yard Roof R</p> <p>2 Pieces</p>
 <p>Front Yard Panel S</p>	 <p>Back Yard Panel T</p>	 <p>Side Yard Panel U</p>	 <p>Walkway V</p>	
 <p>2" W</p> <p>10 Pieces</p>	 <p>1 5/8" X</p> <p>26 Pieces</p>	 <p>1 1/4" Y</p> <p>9 Pieces</p>	 <p>5/8" Z</p> <p>5 Pieces</p>	

Step 1

Attach **(J)** to **(K)** using (4) **(X)** screws. Two per panel.

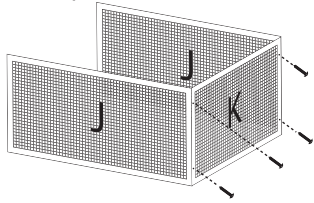

Step 2

Attach **(D)** to **(K)**. Drill (2) **(W)** Screws up into the bottom of **(D)**.

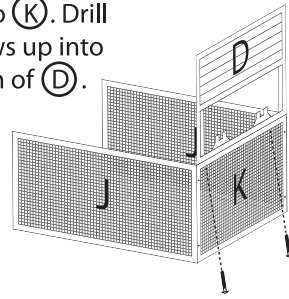

Step 3

Attach **(F)** to **(D)** using (2) **(X)** screws.

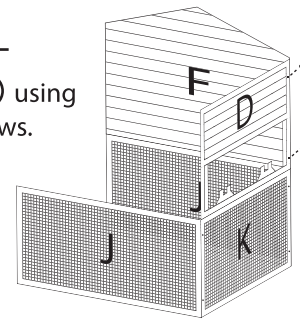

Step 4

Attach **(E)** to **(D)** using (2) **(X)** screws.

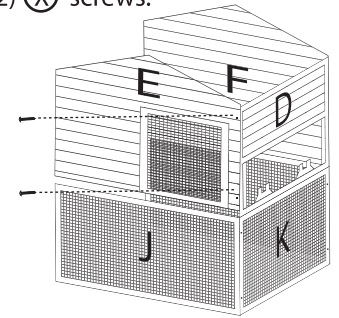

Step 5

Attach both **(L)** panels to **(D)** using (4) **(X)** screws. Two screws per panel.

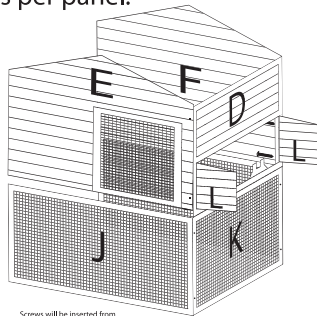

Screws will be inserted from inside the nesting area.

Step 6

Place **(O)** in between both **(L)** panels. No screws required.

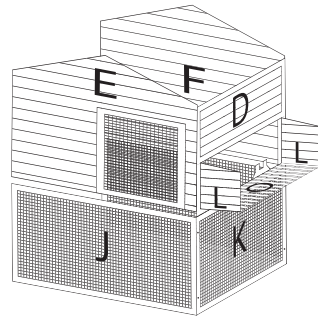

Step 7

Attach **(N)** to both **(L)** panels using (4) **(X)** screws. Two screws per panel.

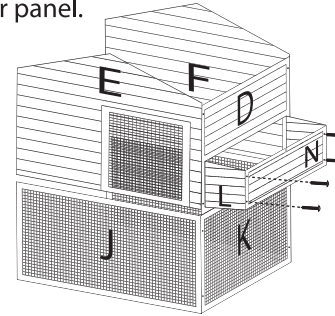

Step 8

Slide **(M)** divider panel into grooves on panel **(N)** and panel **(O)**.

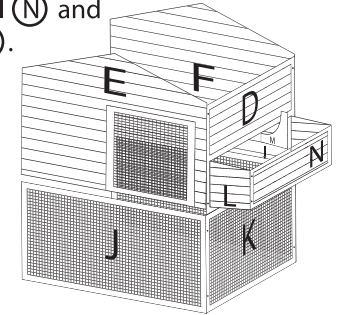

Step 10

Attach **(C)** to **(E)** and **(F)** using (4) **(X)** screws. Two screws per panel.

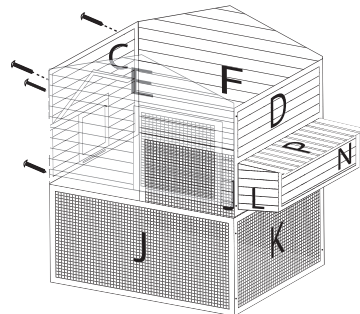

Step 11

Place both **(G)** panels inside, under tray panel **(H)** by setting into place. (optional)

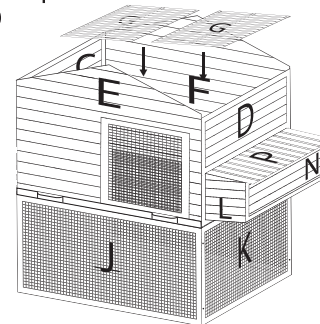

Step 12

Insert **(H)**, by sliding above panel **(E)**. (optional)

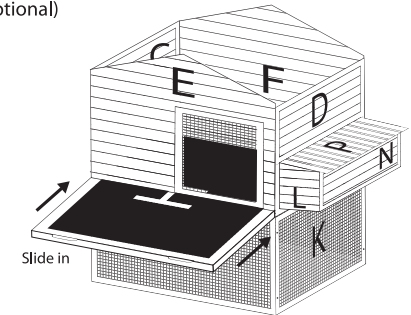

Step 9

Attach **(P)** to **(D)** using (4) **(Z)** screws.

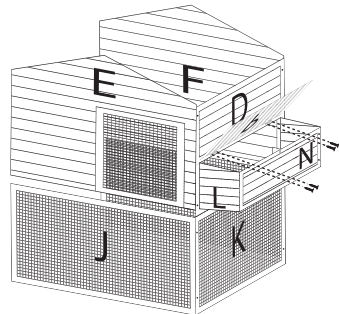

Step 13

Insert both ① perch rails into grooves inside roosting area.

Place both perch bars inside into grooves.

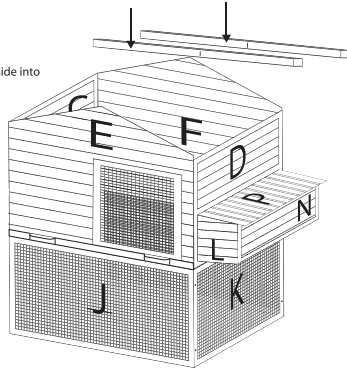

Step 14

Attach door by sliding into grooves on panel ③.

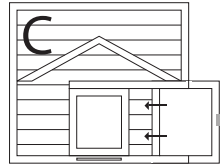

Step 15

Add ⑤ walkway to ledge at bottom of panel ③ using (1) ⑥ screw.

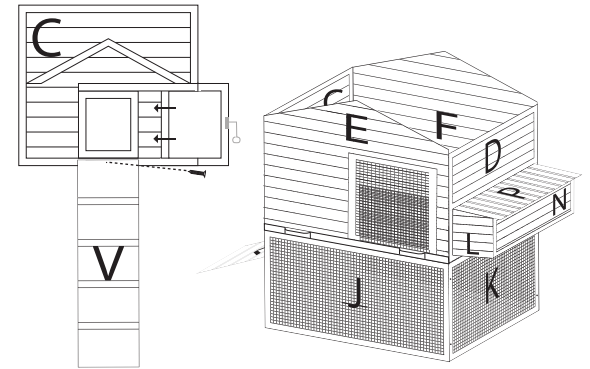

Step 16

Attach ④ to ③ using (4) ⑦ screws.

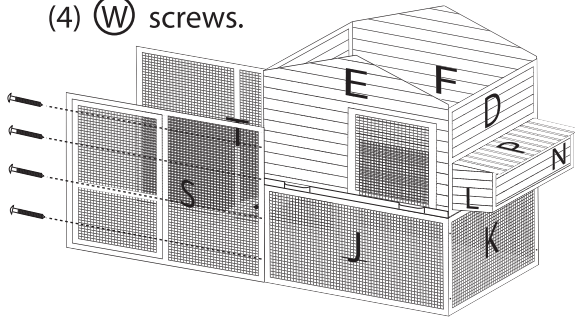

Step 17

Attach ⑧ to ③ using (4) ⑦ screws.

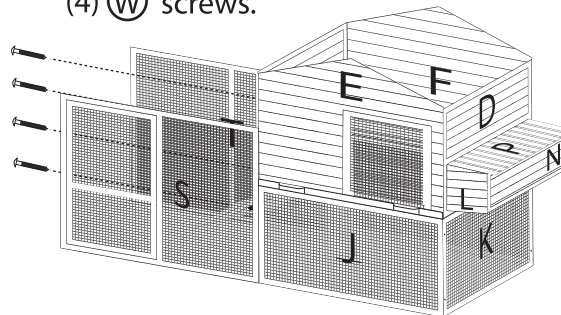

Step 18

Attach ⑨ to ④ and ⑧ using (4) ⑩ screws. Two per side.

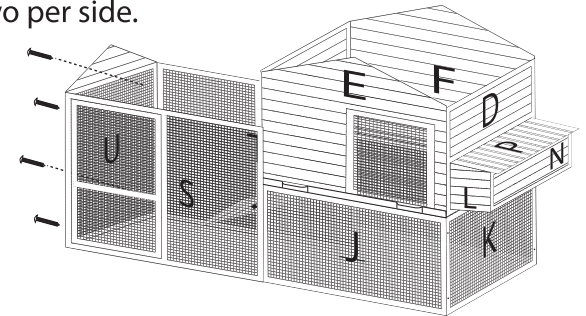

Step 19

Place both ⑪ yard roof panels to yard panels ④ and ⑧. Place ⑫ on top and attach using (4) ⑬ screws. Two per side

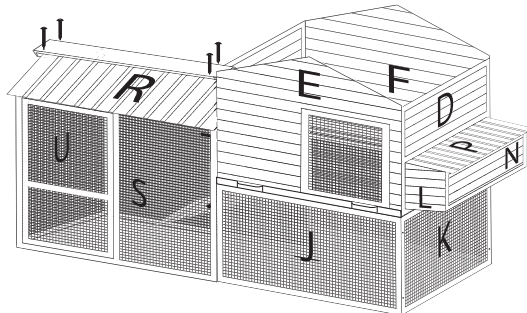

Step 20

Place both ⑭ roof panels to nesting area ⑤ and ⑥. Place ⑮ on top of ⑭ panels and attach using (4) ⑬ screws. Two per side.

