

PetSafe®

Do-It-Yourself Dog Kennel

Step-by-Step Assembly Instructions

Finished size: 7 ½' x 7 ½' x 4' high, 56 ¼ square feet.

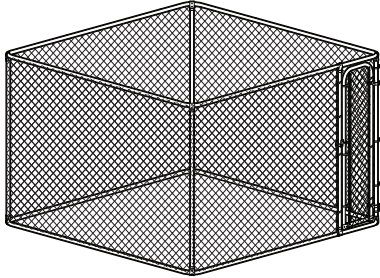

Tools needed:

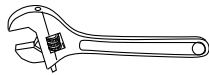

or

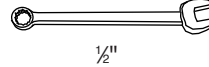

½"

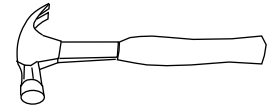

Step 1 CHECK PARTS BEFORE ASSEMBLY:

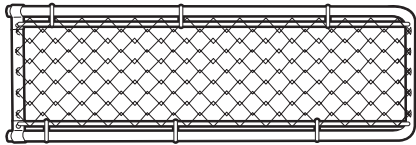

1 - gate



1 - roll chain link fabric

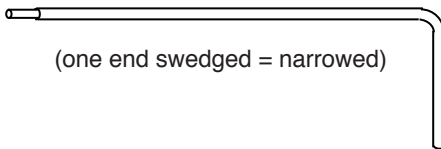

(one end swedged = narrowed)

8 - bent tubing (corner rail)

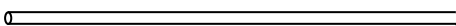

(both ends plain)

5 - straight tubing



(one end swedged)

8 - tubing (frame rail)



2 - tension rod

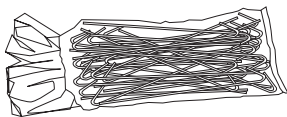

1 - Tie wires (Bag)

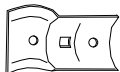

20 - Clamps

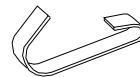

8 - Clips

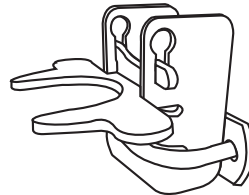

1 - gate latch

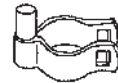

2 - male hinges

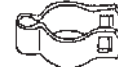

2 - female hinges

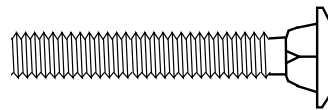

14 - medium carriage bolts

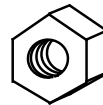

14 - small hex nuts (5/16" hex nut)

Missing parts? Please contact the Customer Care Center at 1-888-632-4453.

Step 2 Assemble kennel on a level surface. Gather four corner rails and four frame rails swedged on one end. Point all swedged (narrowed) ends clockwise.

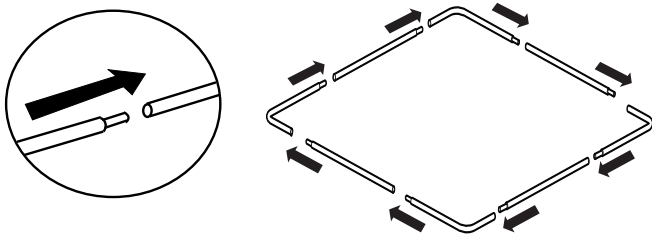

Step 3 Connect the bottom frame. Slip swedged ends of tubing into the next piece of tubing.

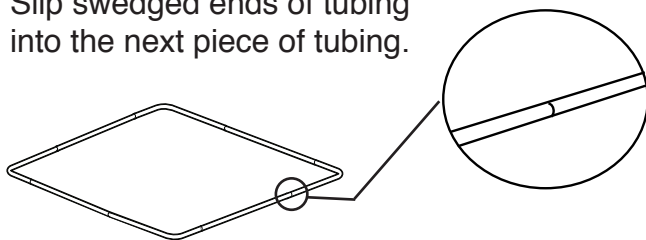

Step 4 Add uprights. Gather: four uprights, eight clamps, four medium bolts, four small nuts and a 1/2" wrench.

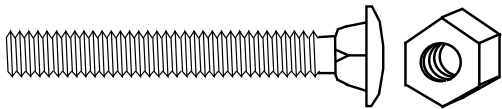

With the nut on top, clamp all posts to the bottom frame at each corner (as shown below)

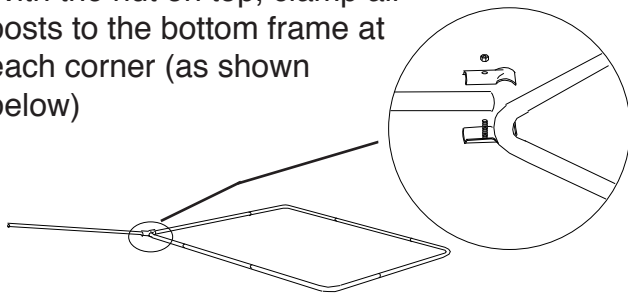

Stand corner posts up and tighten clamps.

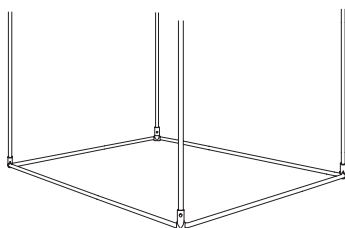

Step 5 Add top rails. Point all top rail swedges clockwise as the bottom frame. Connect them as shown to all posts. Tighten all clamps as you go.

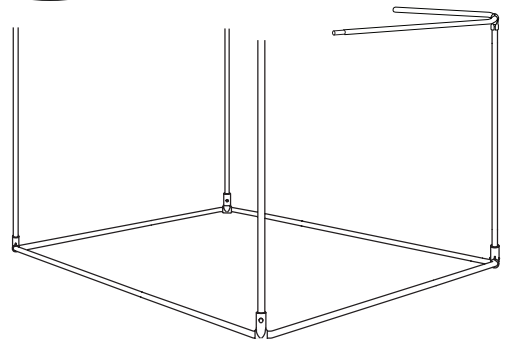
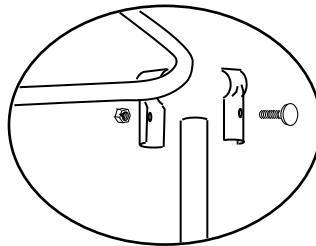

Step 6 Check that all posts are straight up and down.

Step 7 Add an upright post for the gate. The gate can be put 22 1/4" to either side of any of the post. **Do NOT have the gate span a joint in the frame. The frame can come apart at the swedged joint.**

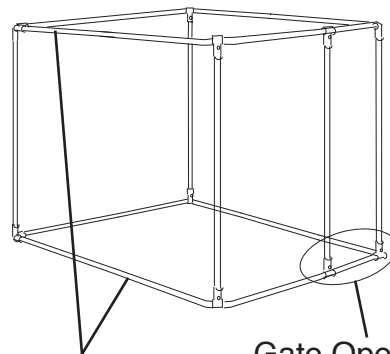

Note: All swedged joints will be loose until fence fabric is installed.

Gate Opening:
22 1/4" between posts.

Step 8 Install the gate.

1. Gather male and female hinges, 4 - 5/16" x 2" carriage bolts with nuts, and the gate.
Note: Gate can open from either side.
2. Install the upper female hinge below the upper most gate clip (8B).
3. Install the lower female hinge directly above the bottom gate clip (8C).
4. Position the gate centered in the gate opening.
5. Attach bottom male hinge and slide up to meet bottom female hinge. Tighten securely (8C).
6. Attach top male hinge and slide down to meet top female hinge. Tighten securely (8B).
7. With an adjustable wrench, install the gate latch 24" from the ground (8A). *Note: The gate latch can be locked. Lock not provided.*

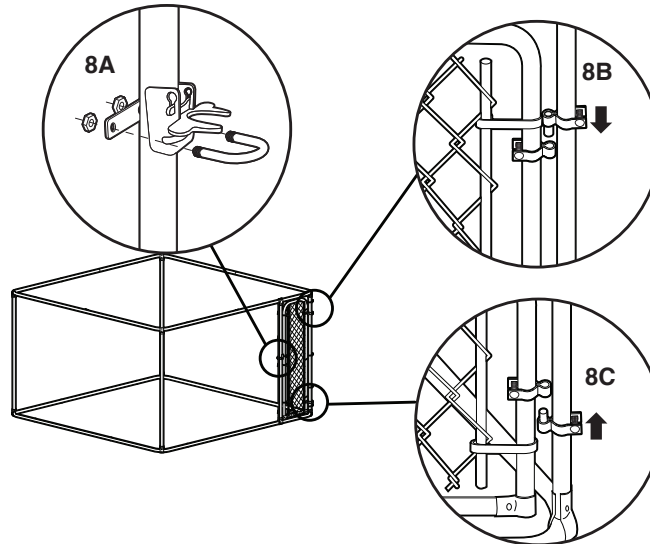

Next put on the fence fabric.

Note: Putting the fabric on is easy, except chain link fabric is strong and stiff and the roll is heavy, so a helper is recommended.

Tools needed

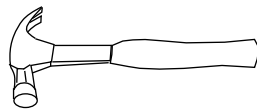

Step 9 Add fence fabric.

Gather 4 clips, one tension rod, package of tie wires, and the roll of wire.

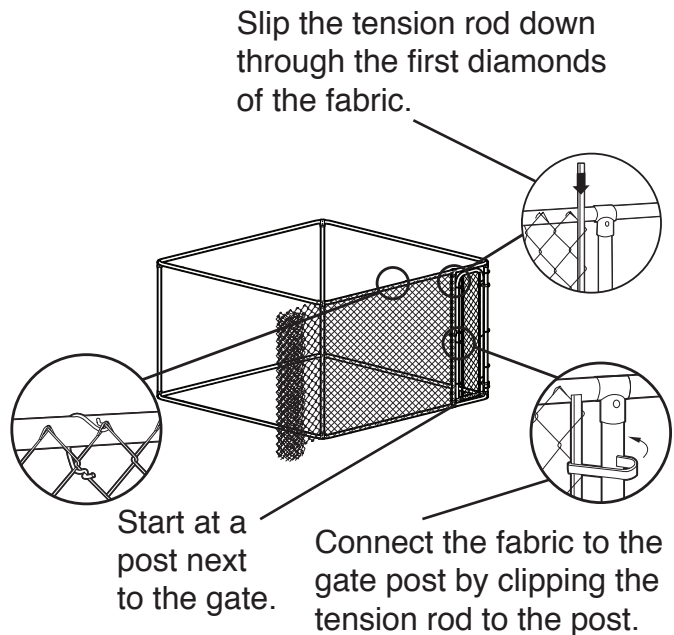

Unroll the fabric around the kennel. Loosely add a tie wire to the top frame about every 5 feet to keep the fabric from falling down.

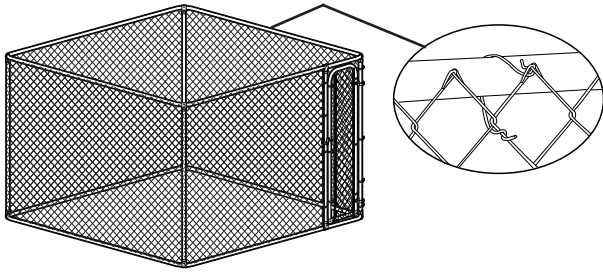

Step 10 Stretch the fabric Starting from the first post away from the gate, use a hammer to stretch the fabric as shown. Add tie wires to posts to hold the fabric stretched. Stretch fabric as tightly as possible. **Be sure all tie wires are on the same picket (wire) or the fabric will be crooked.** Then stretch and tie to the next post, until you go all the way around. Don't tie the last post (at the gate).

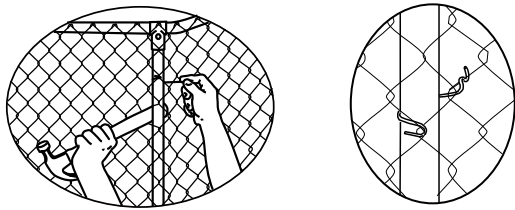

Step 11 Stretch the fabric as tightly as possible to the last post and select a fabric wire to cut, allowing 4 1/2" for the tension rod and clips.

Cut the fabric by holding the fabric loosely while you spin one of the pickets (wires) out.

Here's how:

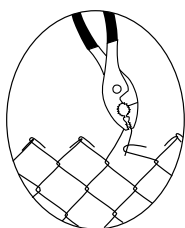

a. Undo the knuckle (loop) at the top and the knuckle at the bottom of the same picket (wire).

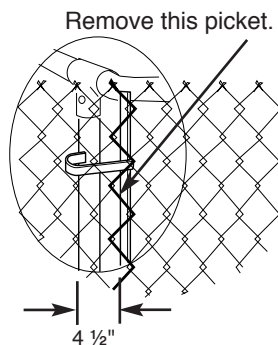

b. Unweave that picket by spinning it. **Be careful! Wire ends are sharp.**

Install the tension rod and 4 clips.

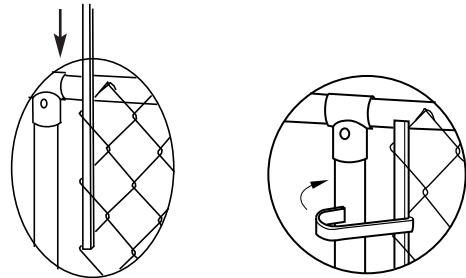

Step 12 Secure the fabric Beginning at the gate opening, attach a tie wire to every third diamond around the top, and every fifth around the bottom of kennel.

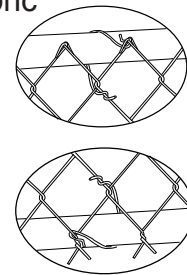

*Use any extra tie wires around bottom for added security.

Note: Attaching tie wires to the bottom is easier if you temporarily raise the bottom of the kennel onto bricks, blocks of wood, or the box the kennel came in.

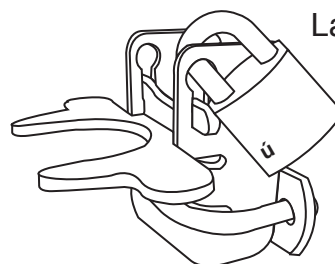

Latch can be locked!

Please - for your pet's safety - train your pet to become accustomed to his/her new home. Consult a professional for help.

PetSafe®

Do-It-Yourself Dog Kennel

Instructions d'assemblage

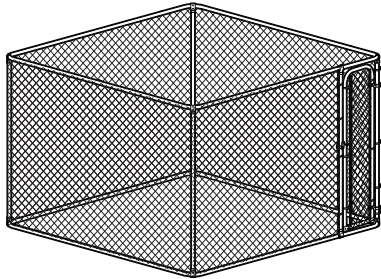

Taille tout assemblé:
2,29 x 2,29 x 1,22 (h) mètres
5,3 mètres carrés

Outillage
nécessaire:

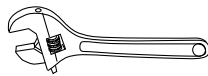

ou



1/2 pouces

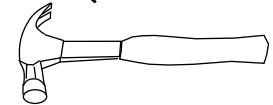

Toutes les pièces sont fournies.

Etape 1 Vérifier le contenu de la boîte:

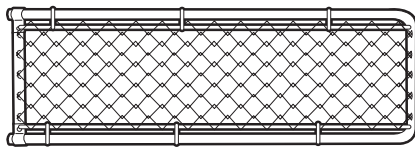

1 - portillon

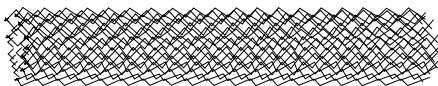

1 - rouleau de
grillage



8 - barres de
coin
(avec embout étroit de
montage d'un côté)

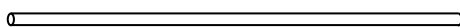

5 - barres
d'armature
droites
(embouts simples)



8 - barres
d'armature
cannelées d'un
côté



2 - barres de
tension

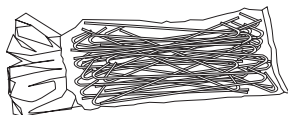

1 - sachet d'attaches
métalliques

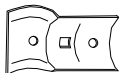

20 - colliers de retenue
(deux pièces)

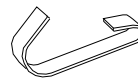

8 - attaches

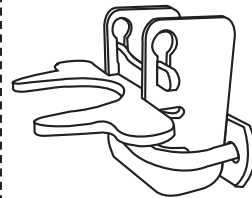

1 - loquet de portillon

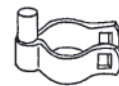

2 Demi-charnières
mâles



2 Demi-charnières
femelles

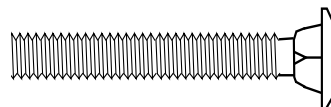

14 - boulons
de carrosserie
moyens

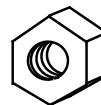

14 - petits écrous
hexagonaux 5/16"

Pièces manquantes? Appelez notre service à la clientèle 1-888-632-4453

Etape 2 Sur une surface plane, posez quatre barres de coin en position, et quatre barres d'armature (cannelées d'un côté), en tournant les de montage (étroits) vers la droite.

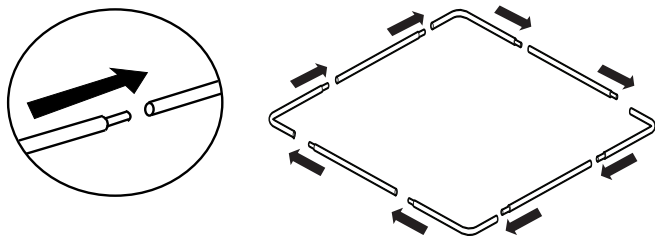

Etape 3 Assemblage de l'armature inférieure
Raccordez les barres les unes aux autres en enfonçant l'embout étroit dans l'extrémité creuse de la barre voisine.

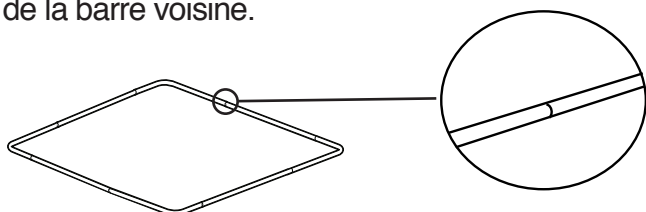

Etape 4 Ajout des montants.
Il vous faut: 4 montants, 8 colliers, 4 boulons de carrosserie moyens, 4 petits écrous hexagonaux et une clé de 1/2 po.

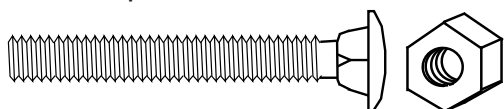

Fixez un montant sur chaque coin de l'armature, en pointant les tiges des boulons vers le haut (voir ci-contre).

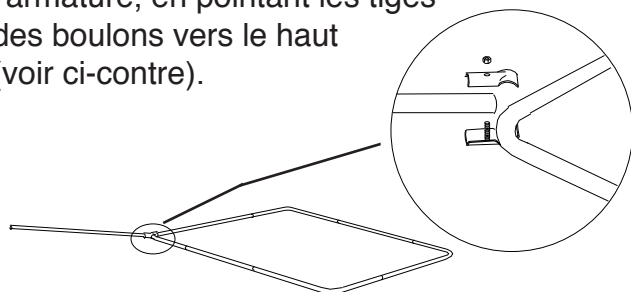

Mettez les piquets de coin debout et serrez les colliers. Laissez les piquets centraux posés sur le sol.

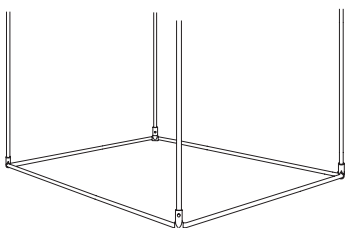

Etape 5 Ajoutez l'armature supérieure.
Tournez le côté le plus long vers la droite, de la même façon que pour l'armature inférieure. Fixez sur les piquets comme illustré. Serrez les colliers au fur et à mesure.

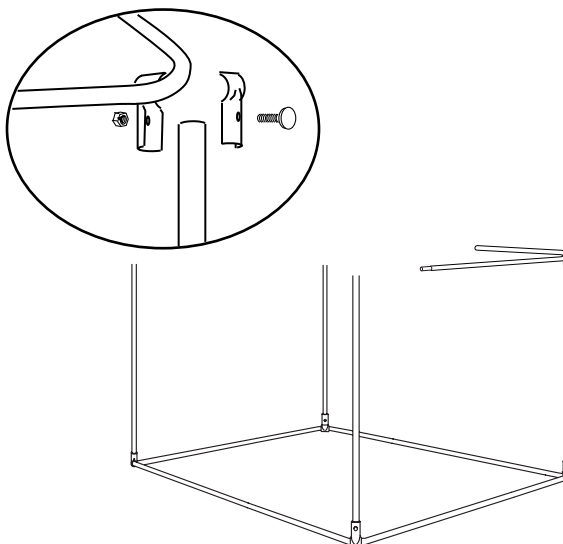

Etape 6 Vérifiez que tous les piquets sont bien droits.

Etape 7 Montage du piquet du portillon
Le portillon se monte à 56,5 cm de n'importe quel coin du chenil. **Evitez cependant de le fixer sur un raccord d'armature. Celle-ci se démonterait.**

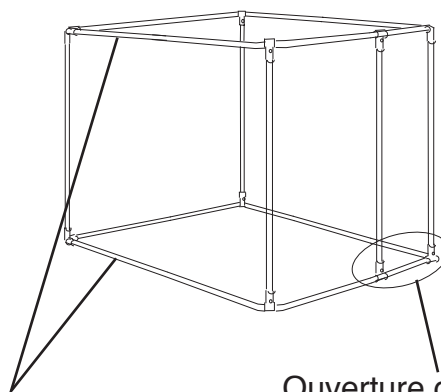

Remarque: l'armature reste lâche jusqu'à l'installation finale du grillage.

Ouverture du portillon:
56,5 cm entre les piquets.

Etape 8 Installation du portillon

1. Il vous faut : des demi-charnières mâles et femelles, 4 boulons de carrosserie de $\frac{5}{16}$ x 2 po avec écrous et le portillon. *Remarque: le portillon peut être monté d'un côté ou de l'autre.*
2. Installez la demi-charnière femelle du haut sous l'attache de portillon supérieure (8B).
3. Installez la demi-charnière femelle du bas immédiatement au-dessus de l'attache de portillon inférieure (8C).
4. Placez le portillon dans l'ouverture en prenant soin de le centrer.
5. Fixez la demi-charnière mâle inférieure et faites-la glisser jusqu'à la demi-charnière femelle du bas. Fixez-les solidement (8C).
6. Fixez la demi-charnière mâle supérieure et faites-la glisser jusqu'à la demi-charnière femelle du haut. Fixez-les solidement (8B).
7. À l'aide d'une clé ajustable, posez le loquet du portillon à 61 cm (24 po) du sol. (8A)
Remarque: le loquet du portillon peut être verrouillé. Cadenas non fourni.

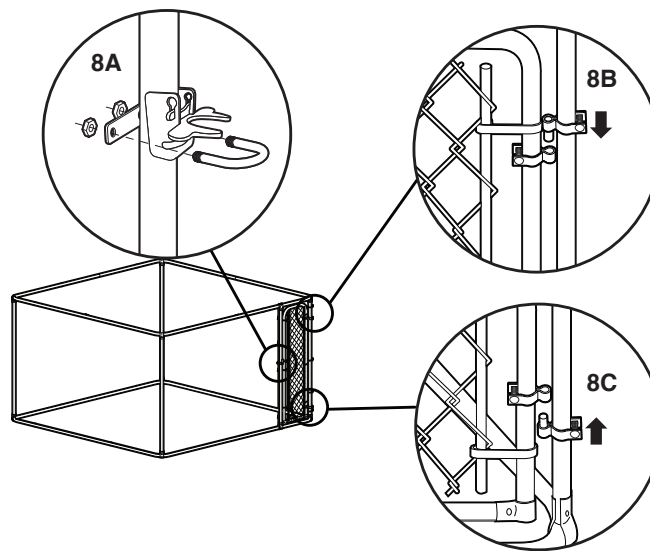

Il ne reste plus qu'à poser le grillage. Rien de plus simple, mais le grillage est lourd et rigide: nous vous recommandons de travailler à deux.

Outils nécessaires

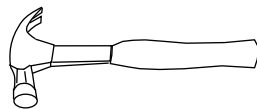

A partir du haut, glissez la barre de tension dans les premières mailles du grillage.

Etape 9 Pose du grillage

Il vous faut 4 attaches, une barre de tension, un sachet d'attaches métalliques et le rouleau de grillage.

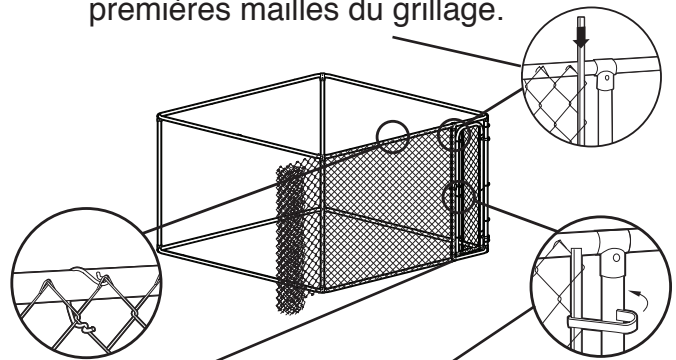

Commencez à un piquet proche du portillon.

Liez le grillage au piquet de portillon en fixant la barre de tension sur celui-ci à l'aide des attaches.

Déroulez le grillage autour du chenil. Sans trop serrer, fixez à l'armature supérieure par une attache métallique, tous les 1,5 m environ, de façon à empêcher le grillage de tomber.

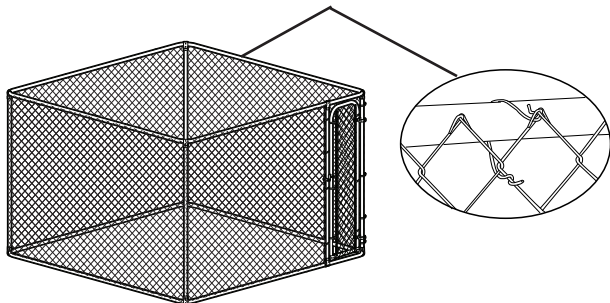

Etape 10 Tension du grillage.

En partant du premier piquet après le portillon, servez-vous du marteau comme illustré pour tendre le grillage. Fixez sur le montant avec des attaches métalliques. Tendez le grillage autant que possible. **Afin de ne pas le déformer, chaque attache métallique doit être fixée sur le même fil métallique.** Continuez de tendre et de fixer le grillage d'un piquet à l'autre, jusqu'à ce que vous ayez fait tout le tour. Ne fixez pas encore sur le dernier montant (au niveau du portillon).

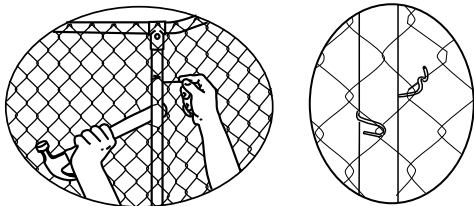

Etape 11 Tendez le grillage le plus possible jusqu'au dernier piquet. Choisissez le fil à couper, en laissant 11,5 cm de marge pour la barre de tension et les attaches.

Coupez le grillage en tenant les mailles pendant que vous défaites l'un des fils. Pour cela:

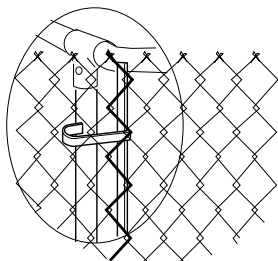
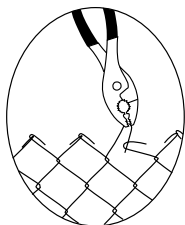

Défaites ce fil de grillage.

a. Défaites la boucle en haut et en bas du fil de grillage choisi.

b. Dégagez le fil du grillage en le tournant. **Attention! L'extrémité des fils est tranchante.**

Installez la barre de tension restante et 4 attaches.

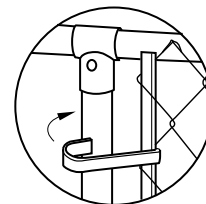
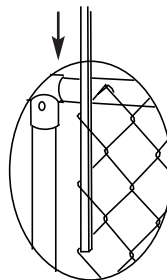
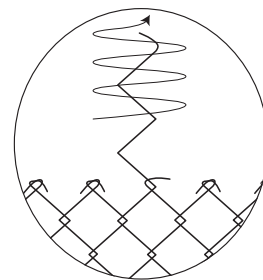

Etape 12 Fixation finale du grillage

En commençant par l'ouverture du portillon, fixez une attache métallique toutes les trois mailles sur le pourtour supérieur du chenil et toutes les cinq mailles sur le pourtour inférieur.

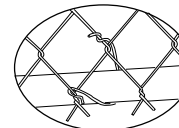
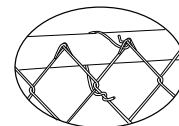

Utilisez les attaches métalliques restantes sur le pourtour inférieur du chenil pour plus de sécurité.

Remarque: pour faciliter la fixation des mailles sur le bas du chenil, placez-le en position surélevée, sur des briques, des cales de bois ou le carton de livraison.

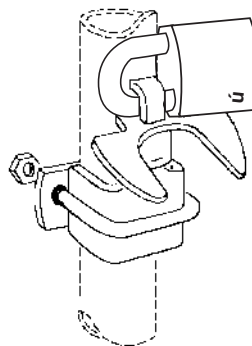

Le loquet peut être verrouillé!

S'il vous plaît: pour la sécurité de l'animal, habituez-le petit à petit à son nouveau logis. Au besoin, demandez conseil à un professionnel.

PetSafe®

Do-It-Yourself Dog Kennel

Instrucciones de montaje paso a paso

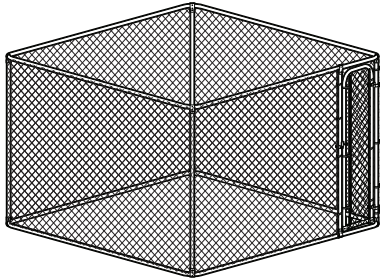

Tamaño terminado:
2,3 m x 2,3 m x 1,2 m de alto
5,2 m cuadrados

Herramientas necesarias:

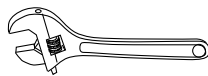

o bien



de ½ pulg

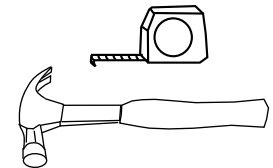

Paso 1 Verifique que estén todas las piezas:

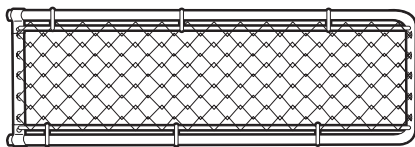

1 - puerta

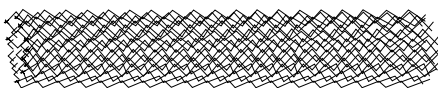

1 - rollo de malla de alambre

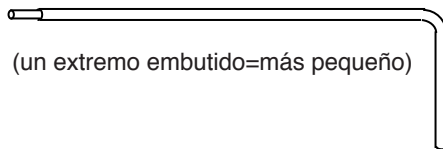

(un extremo embutido=más pequeño)

8 - tubo doblado (riel esquinado)

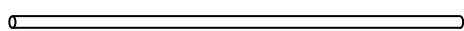

(ambos extremos llanos)

5 - tubo recto

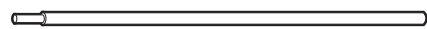

(un extremo con embutido=reducido)

8 - rieles de estructura rectos

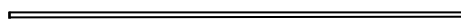

2 - barras de tensión



1 - alambres de atadura (bolsa)

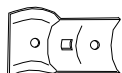

20 - abrazaderas

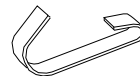

8 - Ganchos

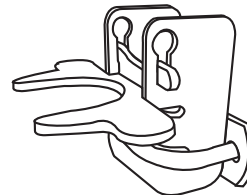

1 - Cerradura de la puerta



2 Bisagras macho



2 Bisagras hembra

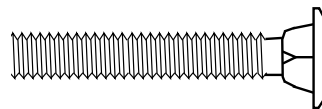

14 - pernos de carrocería mediano

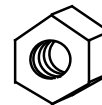

14 - tuercas hexagonales pequeñas (tuerca hexagonal 5/16")

¿Faltan piezas? Comuníquese al Centro de atención al cliente al 1-888-632-4453

Paso 2 Arme la perrera sobre una superficie plana. Tome cuatro rieles esquinados y cuatro rieles de estructura rectos y colóquelos de manera que todos los extremos con embutido (más pequeños) apunten hacia la derecha.

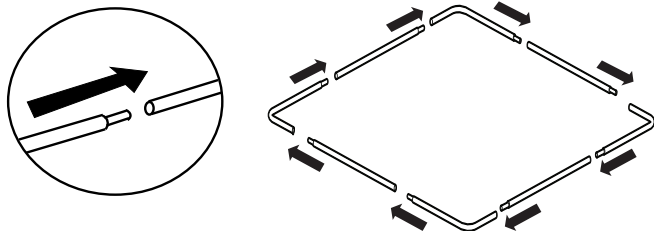

Paso 3 Conecte la estructura inferior. Deslice los extremos con embutido (más pequeños) de los tubos dentro del siguiente tubo.

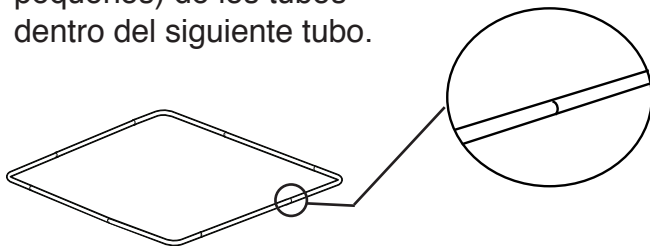

Paso 4 Añada los postes. Tome: cuatro postes, ocho abrazaderas, cuatro pernos mediano, cuatro tuercas pequeñas y una llave de tuercas 1/2 pulg.

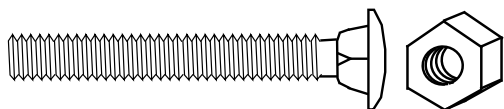

Con la tuerca hexagonal arriba, fije todos los postes a la estructura inferior en cada esquina (tal como se muestra a continuación).

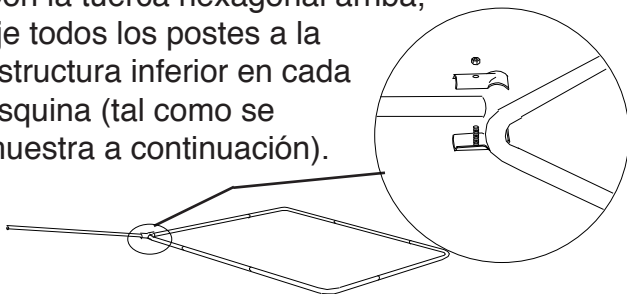

Ponga los postes de las esquinas en posición vertical y apriete las abrazaderas.

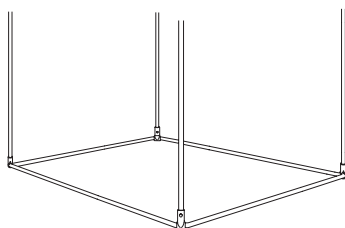

Paso 5 Añada los rieles superiores. Coloque los rieles superiores de manera que las secciones con embutido apunten hacia la derecha, al igual que la estructura inferior. Conéctelos a todos los postes, tal como se muestra. Apriete todas las abrazaderas conforme va avanzando.

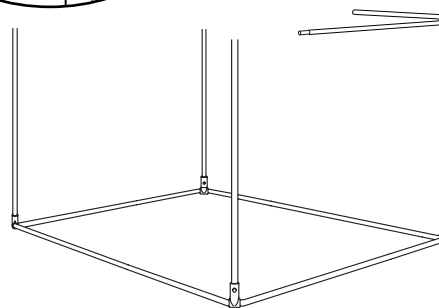
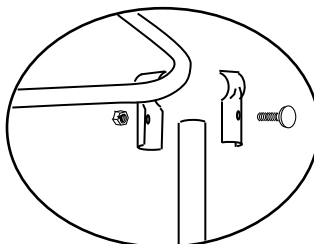

Paso 6 Verifique que todos los postes estén rectos, arriba y abajo.

Paso 7 Añada un poste vertical para la puerta. La puerta puede colocarse a una distancia de 56.5 cm de cualquiera de los postes. **No coloque la puerta de manera que abarque una unión de la estructura. La estructura podría desunirse en la unión con embutido.**

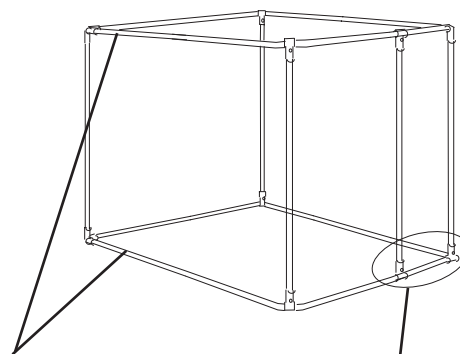

Nota: Todas las uniones con embutido estarán flojas hasta que se instale la malla de alambre.

Abertura de la puerta: 56.5 cm entre postes.

Paso 8 Instale la puerta.

1. Tome las bisagras macho y hembra, 4 pernos de carrocería de $\frac{5}{16}$ " x 2" con tuercas y la puerta. *Nota: La puerta puede abrirse desde cualquier lado.*
2. Instale la bisagra hembra superior debajo del gancho superior de la puerta (8B).
3. Instale la bisagra hembra inferior directamente sobre el gancho inferior de la puerta (8C).
4. Coloque la puerta en el centro de la abertura de la puerta.
5. Fije la bisagra macho inferior y deslícela hacia arriba para unirla con la bisagra hembra inferior. Apriete firmemente (8C).
6. Fije la bisagra macho superior y deslícela hacia abajo para unirla con la bisagra hembra superior. Apriete firmemente (8B).
7. Con una llave de tuercas ajustable instale la cerradura de la puerta a 61 cm del suelo (8A).
Nota: Se puede poner un candado a la cerradura de la puerta. No se incluye el candado.

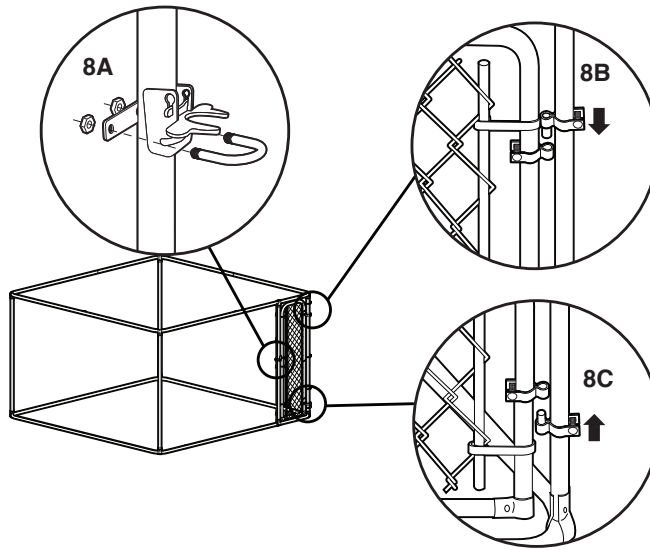

A continuación coloque la malla de la cerca. *Nota: Es fácil colocar la malla, pero como la malla de alambre es fuerte y rígida y el rollo es pesado, se recomienda hacerlo con la ayuda de otra persona.*

Herramientas necesarias

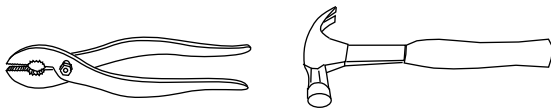

Paso 9 Coloque la malla de la cerca.
Tome 4 ganchos, una barra de tensión, un paquete de alambres de atadura y el rollo de alambre.

Deslice la barra de tensión hacia abajo a través de los primeros lazos de la malla.

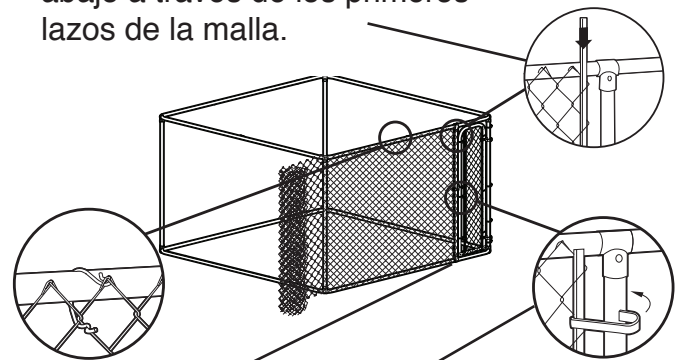

Empiece en un poste ubicado junto a la puerta.

Fije la malla al poste de la puerta sujetando la barra de tensión al poste.

Desenrolle la malla y colóquela alrededor de la caseta. Coloque un alambre holgado sueltamente a la estructura superior aproximadamente cada 1.50 m para evitar que la malla se caiga.

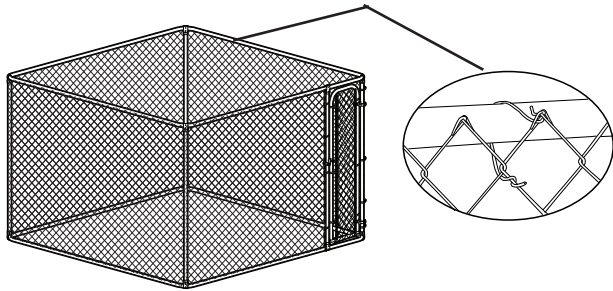

Paso 10 Estire la malla.

Empezando desde el primer poste alejado de la puerta, use un martillo para estirar la malla, tal como se muestra. Coloque los alambres de atadura en los postes para mantener la malla estirada. Estire la malla lo más que sea posible. **Asegúrese de colocar todos los alambres de atadura en la misma línea (de las puntas del cable) o la malla se torcerá.** Luego estírela y átela al siguiente poste, hasta cubrir todo el perímetro. No la ate al último poste (el de la puerta).

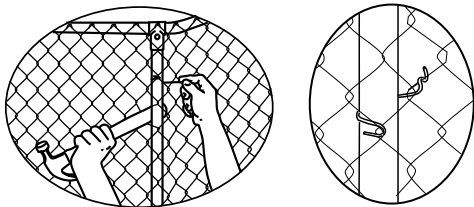

Paso 11 Estire la malla lo más que sea posible hasta el último poste y seleccione un cable de la malla para cortar, dejando 11.5 cm para la barra de tensión y los ganchos.

Sujetando holgadamente la malla, córtela haciendo girar uno de los cables hacia afuera. **Hágalo de la siguiente manera:**

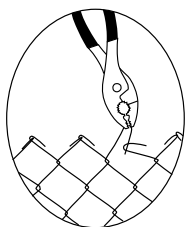

a. Deshaga la articulación (lazo) en la parte superior y la articulación en la parte inferior del mismo cable.

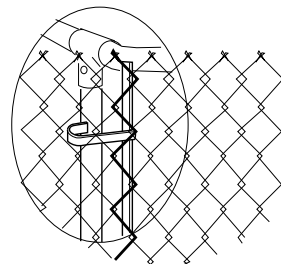

Retire esta cable.

b. Desteja esa punta de cable haciéndola girar. **Tenga cuidado con los extremos filosos del cable.** Instale la barra de tensión y 4 ganchos.

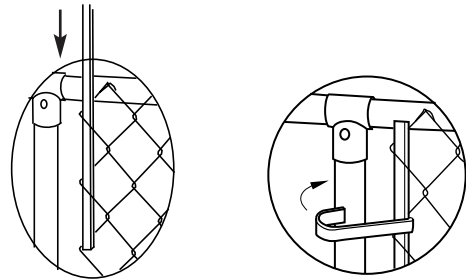

Paso 12 Asegure la malla.

Empezando en la abertura de la puerta, coloque un alambre para atadura en cada tercer diamante alrededor de la parte superior, y en cada quinto alrededor de la parte inferior de la caseta.

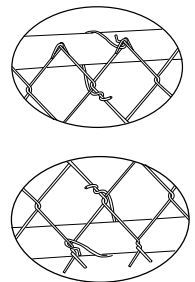

*Para mayor seguridad, use alambres de atadura adicionales alrededor de la parte inferior.

Nota: Colocar los alambres de atadura en la parte inferior es más fácil si levanta temporalmente la parte inferior de la caseta colocándola sobre ladrillos, bloques de madera o sobre la caa en la cual vino.

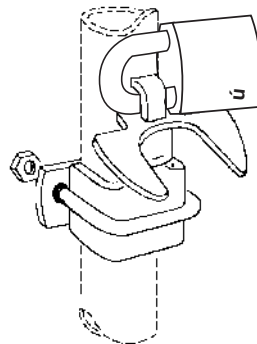

¡Se puede poner un candado a la cerradura!

Por la seguridad de su mascota, entrénela para que se acostumbre a su nueva casa. Si necesita ayuda, consulte con un profesional.