



Animal Management Solutions for Producers

Electric Fencing, Livestock Weighing, EID, Data Management
& Miraco Watering System Catalog



COVER:

THE NEW M10000I FENCE ENERGIZER WILL DELIVER MORE POWER THAN ANY OTHER ENERGIZER AVAILABLE IN THE WORLD.

See for yourself innovative new products like the i Series Fence Energizer System - the fence that can't keep a secret! (pages 6-9)



Producers know that when they purchase a Gallagher product, it comes with a heritage of quality and innovation that has made Gallagher the #1 selling brand of quality animal management products in the world, since 1938.

TABLE OF CONTENTS

POWER SYSTEMS

Energizer Selection Chart	5
110 Volt Energizers	6
Battery Energizers	14
Solar/Battery Energizers	16
Solar Energizers	19
Grounding	22
Power Management Tools	23

FENCING SYSTEMS

Strainers, End Strain Insulators	24
Wood Post Insulators, Connectors & Clamps	25
Steel & Fiberglass Post Insulators	26
Offsets	27
Cable, Wire Braid & Tape	28
Reels	30
Posts, Pigtailed, Treadins, Fiberglass & Tumblewheels	31
Gates & Accessories	32
Netting & Woven Wire	34
Electric Fence Kits	35
Fence Setups	36
Fence Tools & Accessories	38

WEIGHING & ELECTRONIC IDENTIFICATION

Weighing & Data Collectors	39
Platforms	44
Loadbars, Readers & Accessories	44
Sheep Auto Drafter	47
Stock Prods & Accessories	48

MIRACO WATERING TANK SYSTEMS

Mirafount & E-Fount Waterers	50
Lil'Spring Tank Waterers	52
Miraco Installation Diagram	53
EquiFount Waterers	55
BigSpring Tank Waterers	56
Pet Waterer	57
Heaters & Accessories	57

4 Electric Fencing Basics

How Electric Fencing Works

A short, safe and memorable shock to create a psychological as well as a physical barrier.

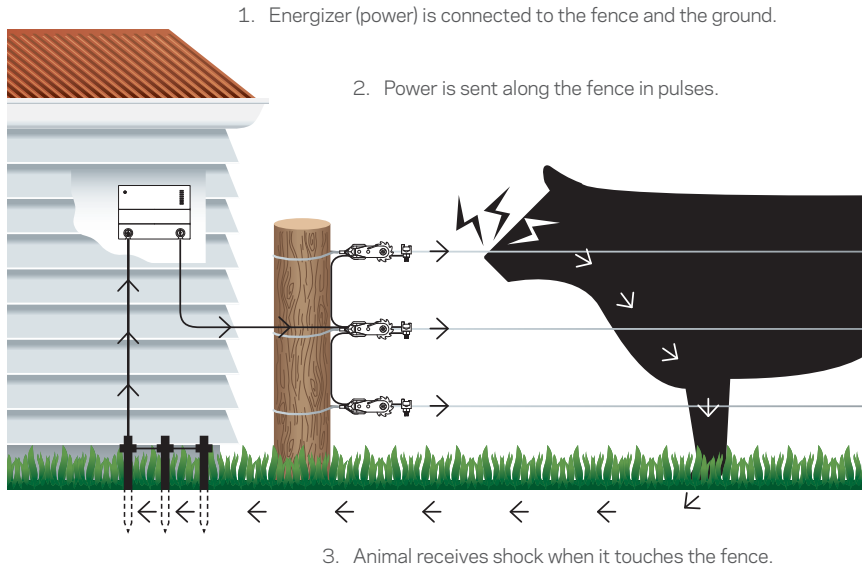

PROFITABLE

Maximize pasture growth, minimize feed costs

SAFE

Animals remember and develop a respect for the fence

DURABLE

Stock pressure on your fence is reduced so it lasts longer

EASY TO INSTALL

Less than half the time to build vs a non-electric fence

ECONOMICAL

Costs less to build and maintain than a non-electric fence

Getting Started

Every electric fence system is made up of an Energizer, a grounding system and a fence system. Selection of these systems depends on property size, fencing usage and animal type.

1) What animals do you want to keep in or out? (See Gallagher Energizer Chart page 5)

2) Total area to be fenced (See Gallagher Energizer Chart page 5)

3) What power source will you use for your Energizer?

Gallagher 110 volt Energizers are the best and most economical choice for areas where you have reliable power. Solar/Battery or Solar powered Energizers are the most logical for remote areas.

4) Do you need a permanent, temporary or offset fence?

- **Permanent:** Long life, permanent electric fences for highly effective animal control that lasts a lifetime.
- **Temporary:** Easy to transport, assemble and take down allowing flexible fencing for short-term animal control or rotational grazing.
- **Offset:** Protect and extend the life of an existing conventional non-electric fence by adding electric wire(s).

2 Year Warranty on All Energizers

All Gallagher Energizers carry a 2 year warranty* (including lightning damage), in addition to a 30-day money back customer satisfaction guarantee.

* With Gallagher lightning protection

Energizer Selection Chart 5

	ENERGIZER	STORED JOULES	'UP TO' DISTANCE CLEAN FENCE (MILES/ACRES)	RECOMMENDED DISTANCE TYPICAL FENCE (MILES/ACRES)	LIVESTOCK CONTROLLED
110 VOLT	M10000i	100.0	1,000 / 6,000	125 / 3,000	
	M5800i	58.0	430 / 2,700	75 / 2,000	
	M2800i	28.0	250 / 1,500	50 / 1,000	
	M1800i	18.0	200 / 1,200	42 / 420	
	M1200i	12.0	120 / 700	37 / 300	
	M1000	10.0	100 / 600	34 / 250	
	M600	6.0	80 / 450	25 / 150	
	M300	3.0	50 / 200	17 / 85	
	M160	1.6	30 / 100	11 / 60	
	M120	1.2	15 / 60	6 / 30	
	M60	0.6	10 / 40	3 / 20	
	M30	0.3	5 / 20	2 / 10	
	M10	0.1	2 / 10	0.5 / 3	
BATTERY	B60	0.6	15 / 60	5 / 40	
	B40	0.4	12 / 50	3 / 25	
	B11	0.11	4 / 20	0.6 / 6	
	B10	0.1	4 / 20	0.6 / 6	
SOLAR / BATTERY	B1600	16.0	180 / 1,000	40 / 400	
	B700	7.0	80 / 450	25 / 200	
	B280	2.8	50 / 200	22 / 110	
	B300	2.6	50 / 200	22 / 110	
	B180	1.8	30 / 100	15 / 90	
	B200	1.45	30 / 100	15 / 90	
	B100	0.8	20 / 70	7 / 60	
	B80	0.8	20 / 70	7 / 60	
SOLAR	S50	0.5	25 / 80	5 / 30	
	S22	0.22	12 / 40	2 / 15	
	S17	0.17	10 / 30	1 / 10	
	S16	0.16	10 / 30	1 / 10	
	S10	0.1	3 / 15	0.5 / 5	

Table is a guide only.

6 110 Volt Energizers

A 110V Energizer System is the best choice if you have reliable power.

All Gallagher 110V Energizers have built in lightning protection and are tested under extreme conditions to ensure unbeatable reliability – delivering outstanding performance day in and day out. Our medium and large Energizers offer extra performance with low power usage by automatically matching power output to fence load, as well as fence monitoring technology giving you total peace of mind your fence is working effectively.

M10000i

G379514

100
JOULES

The world's largest, most powerful Energizer.

- Clean fence distance: 1,000 miles / 6,000 acres
- Typical fence distance: 125 miles / 3,000 acres
- Stored energy (joules): 100
- UL Approved



*A watchful eye on all corners of your fence!
Add up to six monitors to your fence system.*

Energizer Remote & Fault Finder with user replaceable battery.

Fence Monitors placed strategically around your property provide confident animal control & accelerated fence troubleshooting.

i Series Energizer System - the fence that can't keep a secret. Working together the i Series system provides fence information at a glance and if it detects any faults, leads you directly to them, saving you hours of searching.



Energizer Controller allows fence information to be seen in a convenient location up to 160' away from the Energizer.

Energy efficient Energizers, adjust power output to suit your fence conditions. Provides incredible fence performance for the unit's size.

INCLUDED



OPTIONAL ACCESSORIES



PRODUCTS IN DETAIL:

FENCE MONITOR



G51000

Sold separately

A watchful eye on all corners of your fence ↓

Add up to six monitors to your fence system to turn it into a fully monitored set up that keeps the Energizer Controller constantly up to date with fence performance.

- Use across your property to monitor fence voltage and current at up to six different locations (zones)
- Identifies when any zone has a fault and reports back alarms
- Locate fault zones quickly and use the Remote/Fault Finder to pinpoint the problem.

ENERGIZER CONTROLLER



(Not sold separately, included with M10000i, M5800i, M1200i, M1800i, M2800i)

Ground breaking innovation, total peace of mind that your fence is working as it should ↓

Shows all your fence performance information (e.g. voltage, faults and location) in one convenient, separate display box that can be placed up to 160' away from the Energizer itself.

- Displays voltage & current readings at the Energizer and for up to 6 attached Fence Monitors
- Locate in a convenient spot for instant updates eg: side of the shed
- Locate fault zones quickly & use the Controller to turn the Energizer on/off
- Fully waterproof for indoor or outdoor placement.

REMOTE



G50700

Sold separately

Save hours searching for & fixing faults ↓

The Remote pinpoints the fault within the monitored zone and enables you to turn off the Energizer during repair and on again once complete.

- Shows fence voltages and current
- Shows Alarm status for the Energizer and the Fence Monitors
- One Remote can be used on up to 9 Energizers or use multiple Remotes on one (or more) Energizers.

IN ACTION:

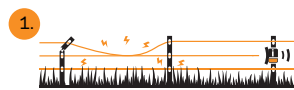

Fence Monitor(s) recognize any significant drop in fence zone or Energizer performance and raise alarms.



Alerts are sent to the Energizer Controller, your mobile phone (via optional SMS Energizer Controller) and/or optional Alarm System.



The Controller and Remote indicate which zone is in fault. The Remote is used to find the fault within the zone.



Power to the fence at the fault location is turned off using the Remote, allowing a safe and convenient repair.



Once the fault is repaired, power is restored to the fence and tested using the Remote.

SMS Energizer Controller ↓

Fence performance information sent via SMS text to your phone. Turn the Energizer on/off from your mobile. Operates on GSM mobile networks. (AT&T & T-Mobile).



G56760

Alarm System ↓

Monitor a section of fence and drive external strobe lights, sirens or alarm panels if the circuit is broken eg: gate opened or a wire cut.



Light G56901

Siren G56902



G57900

8 110 Volt Energizers

M5800i

G308514

58
JOULES

- Clean fence distance: 430 miles / 2,700 acres
- Typical fence distance: 75 miles / 2,000 acres
- Stored energy (joules): 58
- UL Approved

INCLUDED



OPTIONAL ACCESSORIES



M2800i

G306504

28
JOULES

- Clean fence distance: 250 miles / 1,500 acres
- Typical fence distance: 50 miles / 1,000 acres
- Stored energy (joules): 28
- UL Approved

INCLUDED



OPTIONAL ACCESSORIES



Reliable & adaptive performance even in extreme conditions



- Consistent fence performance regardless of extreme temperature conditions or unreliable power supply
- Peace of mind assured with quick scan LED fence performance lights: green = fence ok, red light flashing = fence fault and solid red light = increased fence load
- User safety and reliable animal control with built in lightning and short circuit protection
- Better fence management with output, ground and fence voltage alarms

M1800i

G304504

18

JOULES

- Clean fence distance: 200 miles / 1,200 acres
- Typical fence distance: 42 miles / 420 acres
- Stored energy (joules): 18
- UL Approved



INCLUDED



OPTIONAL ACCESSORIES



M1200i

G303504

12

JOULES

- Clean fence distance: 120 miles / 700 acres
- Typical fence distance: 37 miles / 300 acres
- Stored energy (joules): 12
- UL Approved



INCLUDED



OPTIONAL ACCESSORIES

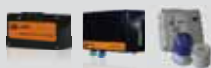

10 110 Volt Energizers

M1000

G382504

10
JOULES

- Clean fence distance: 100 miles / 600 acres
- Typical fence distance: 34 miles / 250 acres
- Stored energy (joules): 10
- Dimensions: 9.6" (w) × 7.5" (h)
- Quickscan Output Voltage: shows output voltage of the Energizer at a glance and a digital output reading
- Ideally suited for large pastures
- UL Approved

LCD voltage and ground displays, provide quick reference to the grounding quality and fence performance.

Quick scan voltage bar graph shows how Energizer is performing at a glance.

Output alarm for better fence management.

Easy to service, modular design.

Green LED indicates normal operation.

Split bolt terminals for easy installation and good connection.

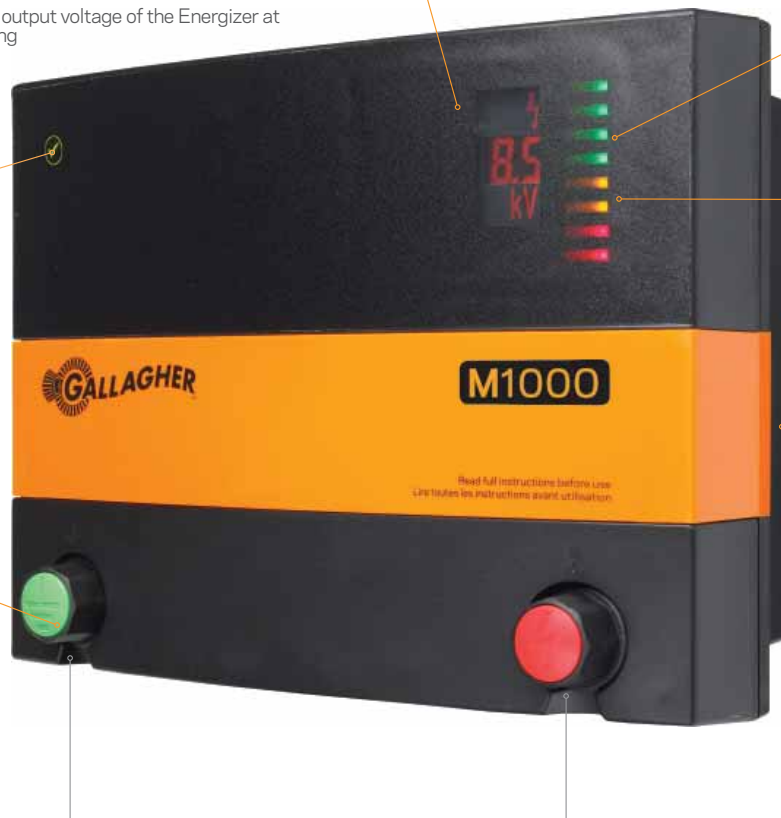

Terminals connect to:
Green - Ground
Red - Lead out Cable and Fence

Grazing Management Tips

- Implementing a rotational grazing system allows producers to be more involved in the effectiveness of their forage and how efficiently their cattle graze.
- Cattle must be trained to electric fencing prior to turnout. Temporary fencing is a cost-effective solution to ensure the animals are ready.
- A simple equation to use to determine the number of paddocks to create: number of days of pasture rest divided by the number of days of grazing, plus one.

M600

G381504

6

JOULES



- Clean fence distance: 80 miles / 450 acres
- Typical fence distance: 25 miles / 150 acres
- Stored energy (joules): 6
- Dimensions: 9.6" (w) × 7.5" (h)
- Quickscan Output Voltage bar graph: shows output voltage of the Energizer at a glance
- Ideally suited for medium pastures
- UL Approved

M300

G380504

3

JOULES

- Clean fence distance: 50 miles / 200 acres
- Typical fence distance: 17 miles / 85 acres
- Stored energy (joules): 3
- Dimensions: 8" (w) × 7" (h)
- Quickscan Output Voltage bar graph: shows output voltage of the Energizer at a glance
- Ideally suited for small pastures
- UL Approved



Green LED indicates normal operation.

Quick scan voltage bar graph shows Energizer performance at a glance.

Split bolt terminals for easy installation and good connection.

Training Livestock with Electric Fencing

All animals need time and space to discover that electrified fences are hot. This education period must occur under conditions of minimum stress. Select a small, well fenced holding pasture and place offset wires on the perimeter about two thirds the height (nose high) of the animals to be trained.

Ground the remainder of the fence to the Energizer ground and electrify the offset wires with the strongest possible pulse to help make the education process more effective.

If necessary, the remainder of the property can be disconnected to ensure the strongest possible shock during the training period.

Training time: the minimum time required is 12 hours and most animals will be fully trained in 48 hours. The aim is to have stock approaching the fences with caution.

Stock trained to electric fence systems will still respect the fence even if it is off for any reason (we do not recommend turning off an electric fence). Animals that have grown up with electric fence systems have remained in paddocks with the power off for several weeks. In recent years, many graziers have found electric fencing a highly efficient and low cost method of controlling unwanted wildlife.

12 110 Volt Energizers

M160

G330444

1.6
JOULES

- Clean fence distance: 30 miles / 100 acres
- Typical fence distance: 11 miles / 60 acres
- Stored energy (joules) : 1.6
- Dimensions: 9.6" (w) × 7.5" (h)
- Green indicator light flashes when Energizer is working properly
- UL Approved



Power on indicator

Ground terminal

Fence terminal



M120

G330434

1.2
JOULES

- Clean fence distance: 15 miles / 60 acres
- Typical fence distance: 6 miles / 30 acres
- Stored energy (joules) : 1.2
- Dimensions: 9.6" (w) × 7.5" (h)
- Green indicator light flashes when Energizer is working properly
- UL Approved



M60

G383414

0.6
JOULES

- Clean fence distance: 10 miles / 40 acres
- Typical fence distance: 3 miles / 20 acres
- Stored energy (joules) : 0.6
- Dimensions: 9.6" (w) × 7.5" (h)
- Green indicator light flashes when Energizer is working properly
- UL Approved





We've taken everything we love about our Energizers and hit the refresh button. The result? Extended mileage with the same unbeatable quality.

M30

G331434

0.3
JOULES

- Clean fence distance: 5 miles / 20 acres
- Typical fence distance: 2 miles / 10 acres
- Stored energy (joules) : 0.3
- Dimensions: 9.6" (w) × 7.5" (h)
- Green indicator light flashes when Energizer is working properly
- UL Approved



M10

G331424

0.1
JOULES

- Clean fence distance: 2 miles / 10 acres
- Typical fence distance: .5 miles / 3 acres
- Stored energy (joules) : 0.1
- Dimensions: 9.6" (w) × 7.5" (h)
- Green indicator light flashes when Energizer is working properly
- UL Approved



14 Battery Energizers

A Battery Powered Energizer System needs a constant current.

If not recharged, the battery will eventually become completely discharged and the Energizer will stop. The amount of current required by an Energizer increases with the size of the Energizer. The amount of charge stored by the battery is measured in Amp-hours (Ah) and increases with the size of the battery. A battery should be chosen which is designed for regular charge and discharge cycles, and for discharging most of its capacity without damage.

Deep cycle batteries are recommended as they are the best compromise between price and life expectancy. A deep cycle battery will typically last two to four times longer than an automotive battery when used for powering Energizers because they are designed to be drained and recharged repeatedly.

Batteries should be placed on a level surface and can be protected against extremes of temperature. They should not be in direct contact with a cold surface such as the ground. Placing suitable insulating material under the batteries or placing them in a battery box and burying the box will also help increase their service life. Ensure that the battery has adequate ventilation to allow gases to escape.

B60

G351504

0.6
JOULES



- Clean fence distance: 15 miles / 60 acres
 - Typical fence distance: 5 miles / 40 acres
 - Stored energy (joules): 0.6
 - Dimensions: 8" (w) x 6" (h)
- Use with a 12-volt, deep cycle battery

B11

G353414

0.11
JOULES



- Clean fence distance: 4 miles / 20 acres
- Typical fence distance: 0.6 miles / 6 acres
- Stored energy (joules): 0.11
- Dimensions: 4.5" (w) x 8.6" (h)

Requires: Six 'D' batteries or external 12V battery (batteries not included). 12V battery leads included.

B10

G36311

0.08
JOULES

- Clean fence distance: 4 miles / 20 acres
 - Typical fence distance: 0.6 miles / 6 acres
 - Stored energy (joules): 0.08
 - Dimensions: 3" (w) x 6" (h)
- Ideal for protecting gardens from animals.



Requires: Six 'D' batteries or external 12V battery (not included). 12V battery leads not included. 12V leads (G52100).

Sold on Gallagher

Marian Ducrest | Broussard, LA

Until I purchased your B10 Energizer, I'd spend weeks tending my vegetable garden only to have the squirrels, raccoons and rabbits lay waste to it before I could bring in a harvest. I'd tried every deterrent recommended in gardening books and journals only to be consistently frustrated when all my hard work put very little food into my freezer. Your B10 has put an end to that frustration. Since putting it into use I have not lost a single fruit or vegetable to the wildlife.

My garden is approximately 50'x50'. My fence consists of 3 strands of Poly Wire, 1 wire at 4 inches, the second at 8 inches, the third at 20 inches, powered by one B10 Energizer. Most of the time I just step over the fence to get into the garden, but when I need to bring in a tiller, interrupting the power is simplicity itself.

See page 35 for Garden & Backyard Protection Kit.

A Battery/Solar Energizer System is a popular choice for those without reliable mains power. These Energizers may be operated with or without a solar panel.

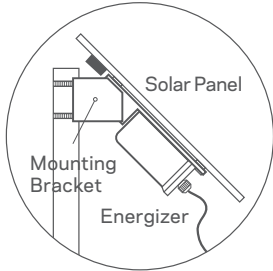

A full Gallagher solar kit set includes:

- High quality fully tested Solar Panels
- A Regulator to protect the battery by controlling the power flow
- Purpose selected deep cycle battery and battery box (battery and battery box only available for S17, S22 & S50)
- Stainless steel Mounting Brackets, Bolts & Clamps for longer life with multiple tilt positions for maximum sunlight exposure

Solar Panels

Watt Power Output
(for charging a 12 volt battery)



B1600

G39600

16
JOULES

- Clean fence distance: 180 miles / 1,000 acres
- Typical fence distance: 40 miles / 400 acres
- Stored energy (joules): 16
- Dimensions: 8.6" (w) x 8.3" (h)

- For remote areas with charging facilities
- Compatible with 90 watt panel
- Complies to RFI (Radio Frequency Interference) standards and has built-in lightning protection circuitry
- Battery consumption, 1,200 milliamps on high power mode and 300 milliamps on maximum save mode
- May be ordered as a solar package (AFR1600)

Quick glance green light shows battery is ok. Flashes red if battery is running low and Energizer slows to half speed to conserve energy.

Flexibility in fence management - choose high, medium or low power operating modes. Also includes low and full output power terminals to operate independently on different fences.



Red light flashes intermittently or not at all if fence is overloaded.

Terminals connect to:
Green - Ground
Yellow - Low Power
Red - Fence Output

Uses a 12-Volt deep cycle rechargeable, marine-type battery. Battery not included.
Use with 90W Solar Panel A80

16 Solar/Battery Energizers

B700

G39500

7
JOULES

- Clean fence distance: 80 miles / 450 acres
- Typical fence distance: 25 miles / 200 acres
- Stored energy (joules): 7
- Dimensions: 8.6" (w) × 7.9" (h)
- One fully charged 12 volt 100 amp hour battery will operate for approximately 8 days on high power, 14 days on low power
- Compatible with a 40W Solar Panel
- May be ordered as a Solar Package (AFR700)

Flashing red light shows when battery is low and Energizer slows to half speed to conserve energy.



Neon fence light flashes intermittently or not at all if fence is overloaded.

Uses a 12- Volt deep cycle rechargeable, marine-type battery. Battery not included.

Switch to select high or low power.

B280

G366504

2.8
JOULES

- Clean fence distance: 50 miles / 200 acres
- Typical fence distance: 22 miles / 110 acres
- Stored energy (joules) : 2.8
- Dimensions: 8" (w) × 6" (h)
- Built in battery-save feature extends battery life.
- Easy to use 5-stage rotary dial to change Energizer operating functions.
- May be ordered as a Solar Unit (AFR280)
- Convert to 110v (G40100) optional

Rotary dial to change Energizer operating functions.

- Battery Check
- Off
- Full Power

Battery save modes

- Random pulse 2.6x more battery life
- Night save 1.8x more battery life

Quick glance indicator light shows battery and fence voltage performance.



Split bolt recessed terminals for easy installation and good connection.

B300

G39400

2.6
JOULES

- Clean fence distance: 50 miles / 200 acres
- Typical fence distance: 22 miles / 110 acres
- Output energy (joules) : 2
- Dimensions: 12.6" (w) × 15" (h)
- Highly visible low-battery and fence-voltage indicator lights
- Carrying handle for easy transportation
- Weatherproof enclosure to contain battery
- May be ordered as a solar unit (G394SK)
- Replacement fence and ground leads (G57300)
- Unit has a hole in the bottom enabling it to be staked to prevent theft

B200

G393454

1.45
JOULES

- Clean fence distance: 30 miles / 100 acres
- Typical fence distance: 15 miles / 90 acres
- Stored energy (joules) : 1.45
- Dimensions: 12.6" (w) × 15" (h)
- Highly visible low-battery and fence-voltage indicator lights
- Carrying handle for easy transportation
- Weatherproof enclosure to contain battery
- May be ordered as a solar unit (G393SK)
- Replacement fence and ground leads (G57300)
- Unit has a hole in the bottom enabling it to be staked to prevent theft

Uses a 12- Volt deep cycle rechargeable, marine-type battery. Battery not included.



Quick glance indicator lights show battery and fence performance.

Flexible fence management - choose from full or half power mode to extend battery life.

Carry handle for easy transportation.

Versatile animal control - vary Energizer pulse modes to suit different animals.

Easy battery installation, with simple clip lock case.

B100

G392454

0.8
JOULES

- Clean wire distance: 20 miles / 70 acres
- Typical fence distance: 7 miles / 60 acres
- Stored energy (joules) : 0.8
- Dimensions: 12.6" (w) × 15" (h)
- Highly visible low-battery and fence-voltage indicator lights
- Carrying handle for easy transportation
- Weatherproof enclosure to contain battery
- May be ordered as a solar unit (G392SK)
- Replacement fence and ground leads (G57300)
- Unit has a hole in the bottom enabling it to be staked to prevent theft

Shown here with solar panel. Please ask about our Solar Kit.

18 Solar/Battery Energizers

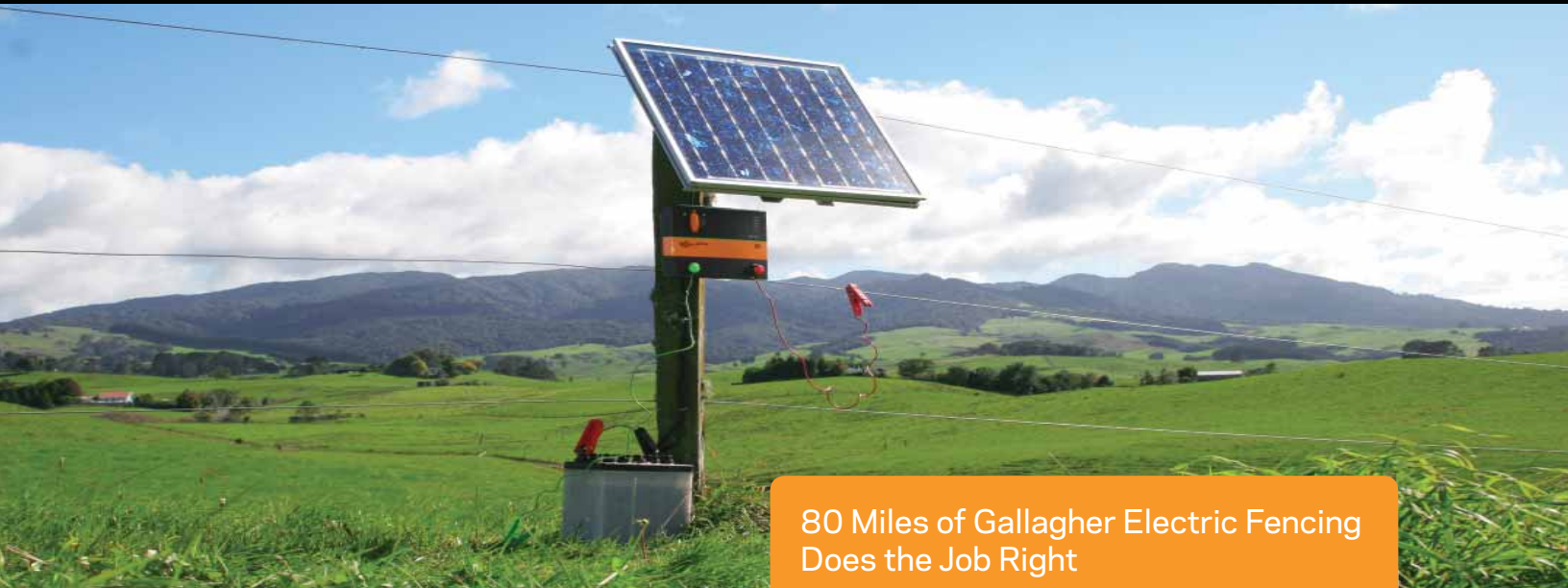

80 Miles of Gallagher Electric Fencing Does the Job Right

B180

G364504

1.8
JOULES



- Clean fence distance: 30 miles / 100 acres
- Typical fence distance: 15 miles / 90 acres
- Stored energy (joules): 1.8
- Dimensions: 8" (w) x 6" (h)
- Built in battery-save feature extends battery life.
- Easy to use 5-stage rotary dial to change Energizer operating functions.
- Compatible with 10 Watt Solar Panel
- Order as Solar Unit (AFR180)

B80

G362504

0.8
JOULES



- Clean fence distance: 20 miles / 70 acres
- Typical fence distance: 8 miles / 55 acres
- Stored energy (joules): 0.8
- Dimensions: 8" (w) x 6" (h)
- Built in battery-save feature extends battery life.
- Easy to use 3-stage rotary dial to change Energizer operating functions.
- Compatible with 10 Watt Solar
- Convert to 110V (G40100)
- Optional solar package (AFR80)

Doak Elledge makes good use of electric fencing on the 11,000 acre Faudree Ranch, near Pampa, TX. The ranch is made up of 60 permanent pastures, varying from 15-680 acres. About 175 acres of improved pasture is subdivided with temporary fencing using Gallagher Tumblewheels and reels with Poly Tape.

"We have been using electric fencing since 1982," says Elledge. "We use 2 and 3 wire fence on permanent divisions and signal wire with temporary fencing. We run one herd of 450-500 cows in the summer and we pasture another, 850-900 yearlings."

"The main reasons we went to electric fencing were the lower costs and the maintenance efficiencies. We can construct approximately 4-5 miles of electric fence at about the same cost for 1 mile of barbed wire fence."

For new cattle, Elledge uses training traps with 4 and 5 wire electric fence. "Usually, after 1-2 days the cattle leave the fences alone," explains Elledge. "Most of the fence with the cow herd is 2 wire. The bottom wire is ground and the top wire is hot. This way, when the calves are young they can cross back and forth."

"We are constructing many of our fences with Gallagher Fiberglass posts," says Elledge. "So far, we really like this new type of fence. There are a lot of new products for electric fencing and they offer real advantages over the old style of construction, but even at that some of our 10 year old electric fences are still holding up well."

Are you looking for an Energizer that generates free energy and is environmentally friendly? Go solar. Check out our full line up of high quality, reliable solar systems that are a cinch to install and will last for years.

S50

G359404

0.5
JOULES

- Clean fence distance: 25 miles / 80 acres
- Typical fence distance: 5 miles / 30 acres
- Stored energy (joules) : 0.5
- Dimensions: 17" (w) × 18" (h)
- Safe, powerful animal control designed for outdoor and portable use
- Can be mounted on a wall, wood post, T-Post, or sit on the ground
- Highly visible rotary dial for turning the unit off and on
- Impact resistant plastic lens to protect the solar panel
- Easy to maintain and clean
- Maintenance-free rechargeable battery included

Can be used for both permanent and portable fencing as it can be mounted on a wall, wooden post, t-post or placed on the ground.

Large rotary dial makes it easy to check unit is on from a distance.

LED light indicates normal operation.

Automatic Night Save mode to extend battery life.



12V rechargeable battery and fence leads included.

S50 RECHARGEABLE BATTERY
APC12100
Used in the Gallagher S50 Energizer.

APC12100 S50 Replacement Battery available for individual purchase

G59830 Fence and ground leads



Consistent, reliable fence performance with a built in solar panel to charge the battery

20 Solar Energizers

S22

G344414

0.22
JOULES

- Clean fence distance: 12 miles / 40 acres
- Typical fence distance: 2 miles / 15 acres
- Stored energy (joules) : 0.22
- Dimensions: 11.6" (w) × 12" (h)
- Large terminals enable correct grounding for best Energizer performance
- High-impact, UV-resistant plastic case for weatherproof, rust-proof, insect-proof outdoor use
- Maintenance-free rechargeable battery included
- Fits on top of steel t-post
- Automatic night save mode to extend battery life
- Battery & leads included

Built in solar panel charges battery for consistent, reliable fence performance.

S17/S22 RECHARGEABLE BATTERY 6V A670
Used in the Gallagher S17 & S22 Energizer.

A670 S17 Replacement Battery available. Fence and ground leads (G59800).



S17

G344404

0.17
JOULES

- Clean fence distance: 10 miles / 30 acres
- Typical fence distance: 1 mile / 10 acres
- Stored energy (joules) : 0.17
- Dimensions: 11.6" (w) × 12" (h)
- Large terminals enable correct grounding for best Energizer performance
- High-impact, UV-resistant plastic case for weatherproof, rust-proof, insect-proof outdoor use
- Maintenance-free rechargeable battery included
- Fits on top of steel t-post
- Automatic night save mode to extend battery life
- Battery and leads included

S17/S22 RECHARGEABLE BATTERY 6V A670
Used in the Gallagher S17 & S22 Energizer.



S16

G341414

0.16
JOULES

Operates up to 3 weeks without sun!

- Clean fence distance: 10 miles /30 acres
- Typical fence distance: 1 mile / 10 acres
- Stored energy (joules) : 0.16
- Dimensions: 11.6" (w) × 12" (h)
- Large terminals enable correct grounding for best Energizer performance
- High-impact, UV-resistant plastic case for weatherproof, rust-proof, insect-proof outdoor use
- Maintenance-free rechargeable battery included
- Fits on top of steel t-post
- Automatic night save mode to extend battery life
- Ideal for managed grazing, this robust and portable unit makes a great alternative to battery powered systems.



360 Degree T-Post mount allows the Energizer to mount onto existing posts.

Built in solar panel (1.5 Watt) charges battery for consistent, reliable fence performance.



Battery light indicator

Water resistant case & components with built-in lightning protection. Designed to be left outside in all weather conditions.

S10/S16 RECHARGEABLE BATTERY 6V A950
Used in the Gallagher S10/S16 Energizers.

A950 S10/S16 Replacement Battery available. Fence and ground leads (G59300).

S10

G341404

0.1
JOULES

Operates up to 3 weeks without sun!

- Clean fence distance: 3 miles / 15 acres
- Typical fence distance: 0.5 miles / 5 acres
- Stored energy (joules) : 0.1
- Dimensions: 9" (w) × 10.5" (h)
- The Energizer comes with a battery and solar panel. Leads are not included
- Automatically slows down at night when livestock are less active to conserve battery power
- Built in lightning protection
- Designed for all weather conditions
- Will continue to work for up to three weeks without sun



360 Degree T-Post mount allows the Energizer to mount onto existing posts.



S10/S16 RECHARGEABLE BATTERY 6V A950
Used in the Gallagher S10/S16 Energizers.

A950 S10/S16 Replacement Battery available. Fence and ground leads (G59300).

22 Grounding

Eight out of ten problems are due to improper grounding

Setting up a good grounding system is often overlooked but it's critical. It's how the power flows from the Energizer, to the fence, through the animal and back through the ground to the Energizer. Without good clean ground rods in sufficient size and number the ground connection doesn't work and the shock will not reach the animal.

For Wetter Regions

For use in greener regions where the fence can be simplified to an 'all live wire' system.

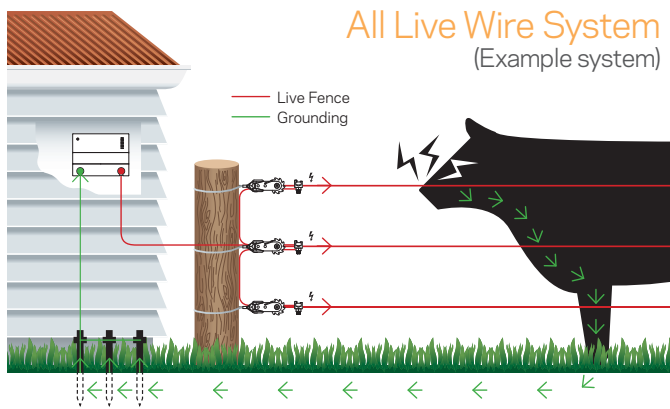

For Drier Regions

For use where the ground struggles to conduct enough power. A 'ground return system' is created where the live & ground wires on the fence create the shock when the animal touches them both at the same time.

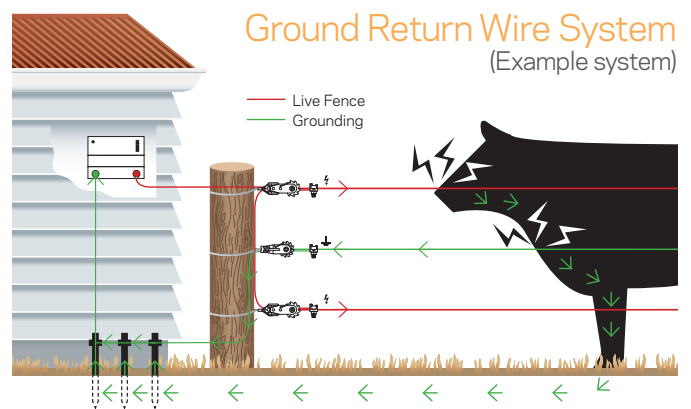

Handy Hint

The rule for ground stakes when installing permanent fencing

- 10' Between ground rods
- 3 Ground rods minimum*

- 6' Minimum length of rods
- 1 Wire connecting all rods to Energizer ground terminal

As a rule of thumb, use at least 3 ground rods or the Energizer Stored Joules rating divided by 5.

GROUNDING

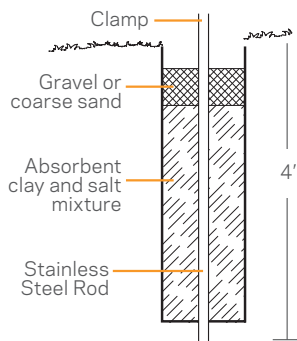

Recommended grounding option; equivalent to **three** ground rods. Particularly effective in poor grounding soils.

6' Ground Rod
A351

3' Ground Rod
A351A

HD Ground Rod Clamp
A352HD

HD Ground Rod Clamp (3 pk)
A363HD

Complete 3-Ground Rod Kit
A655

- Three 6' galvanized rods
- Heavy-duty clamps
- 50' of 12 gauge galvanized wire

Super Grounding Kit
G88000

- One stainless steel rod
- One galvanized ground clamp
- 13.5 lbs of absorbent mixture
- The equivalent to using three 6' ground rods



FENCE TESTERS

Fence Volt/Current Meter and Fault Finder G50905

Save hours searching for and fixing faults!

- Large easy to read LCD display shows voltage & current
- Large arrows show direction of fault
- Auto On/Off when fence pulse detected



Energizer Remote and Fault Finder G50700

Quickly and easily locates fence faults. Once fault located turn the Energizer off remotely to allow safe and convenient fence repair. Rugged and reliable with a tough, water resistant casing.

Compatible with M10000i, M5800i, M1800i & M2800i



Fence Volt Meter G503014



Digital read out for accurate fence voltage measurement.

Fence Volt Indicator G501004



Simple indicator lights show approximate fence voltage levels.

FENCE MANAGEMENT TOOLS

Live Fence Indicator G51100

Know your fence is working!

Place permanently on your fence and simply look for the LED flash, for instant reassurance that the fence is working.

- No batteries required. Uses power from the fence (2kv or 2000 volts or higher)
- Highly visible LED can be seen during day/night (up to .5 mile at night)
- Long life - water and UV resistant
- Simply put ground rod in and clip on to fence wire or tape.



Cut Out Switch G60731

A handy tool that allows a section of a permanent fence to be switched off for maintenance or fault finding.

- High quality phosphorous bronze contacts for long life & maximum effectiveness
- Highly visible on/off switch for status checking at a glance
- Full sealed, weatherproof & dirt resistant.



Knife Cut Out Switch (Knife) G610



Alternative cut out switch option.

- Stainless steel contacts
- Easy to see open or closed status
- Use at gates and for easy location of fault finding
- Switch off a section of fence for maintenance and routine checks

SAFETY & PROTECTION

Flood Gate Controller G60400



Install on flood gates to prevent significant power loss when the water way is flooded.

Voltage Spike Protector A209



Protect your fence from damaging power surges.

Lightning Diverter G64800

Also available porcelain (A207)



Gallagher recommends that all Energizers be fitted with a lightning diverter to help protect from lightning damage. This diverter will withstand multiple lightning strikes and can be adjusted to fit any Energizer.

Warning Sign G602404



A highly visible sign that warns that a fence is electrified. Required by law, to be used on boundaries and anywhere else public have access to a fence.

24 Strainers, End Strain Insulators

**GROUND BREAKING
UV RESISTANT MATERIAL**
Improves insulator life by
maintaining flexibility on the fence



STRENGTH



WARRANTY

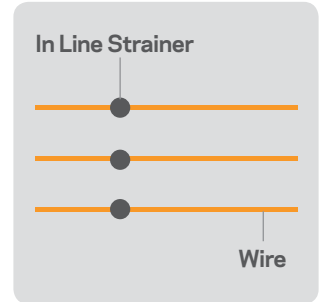
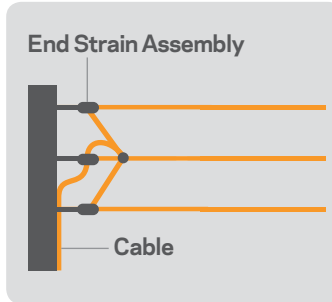

END STRAIN INSULATORS AND STRAINERS

High Strain Insulator

White: G67812
Black: G67702



Strongest, long term end strain insulation for high tensile permanent electric fencing.



Porcelain Doughnut Insulator

G674034



Fire resistant, high quality glaze finish porcelain doughnut is 1.5" in diameter.



High Strain Insulator Kit

G61814



Simplest option for end strain insulation; comes with pre-attached wire rope. Fits up to 7.5" posts. No wire tying or special tools needed.



Porcelain Bullnose Strain Insulator

G692034



This long-life, fire resistant insulator is suitable for long strains of permanent fence.



Insulated Wire Strainer Kit

G618034



No wire tying, fast & simple. Includes all three end strain elements - insulator, strainer and steel rope. Simply slide over the post and you're done. Fits up to 7.5" post.



Screw-In Tie Down & Handle

G61500 Tie Down
G615014 Handle



Ensures a secure fence tie down. Tie down and handle sold separately



Insulated Tube

G614134 - White
G614034 - Black



23" Long protective strips for poly wire or braid. Available in white 82' coil.



Insulated Wire Strainer

G79553



Combined end strain insulator and strainer. Simply tie onto strainer post and wind fence wire onto spool. Tighten with G69530 ratchet handle.



Insulated Tube

A213



100' coil. Alternative to longer life, higher strength insulators.



Wire Strainer

G79504



Ratchet style wire strainer. Can also be used in-line by threading through strainer. Tighten with G69530 ratchet handle.



End/Corner Tensioner

AH125



Firmly secures 1.5" tape. The unique clasp on this impact resistant polyethylene prevents movement and helps eliminate wear.

Permanent Tension Spring

A290

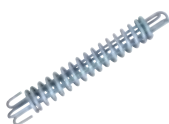

A versatile product with in-built over-stretch protection. Use for:

- Fences with frequent snow loads
- Enabling irrigators to pass over fence lines
- On very short fence lines to maintain tension and prevent excessive strain on end posts.



Tape End Tensioner

AH120



In Line Wire Tightener

G64304
G64302 - 5 Pack



Fits over wire for mid-fence straining, increasing effectiveness of strain by pulling from both directions. Ideal for tightening existing fences or trellising wires.



1.5" Tape Joiner

AH105



Used to join 1.5" tape. This stainless steel material is rust resistant.



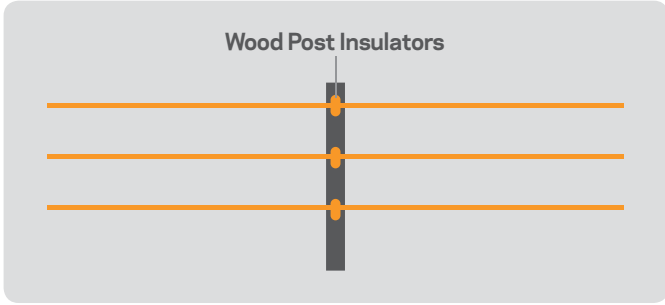

WOOD POST INSULATORS

Wood Post Claw Insulator
G67304



The most popular choice for permanent electric fencing using wood posts.



Wood Post Pinlock Insulator
G68704 - Black
G687144 - White



Used with high-tensile wire.



Wood Post Screw-in Ring Insulator
G66604 - Black
G667 - White



Angled slot allows quick securing and safe holding of wire. No need to create pilot hole first, simply screw into soft wood.



Wood Post Wide Jaw Claw Insulator
G67614 - White
G676044 - Black



Specifically for Equine Fence Wire, the most popular choice for permanent equine fencing using wood posts.



Wood Post Equine Pinlock Insulator
G626144 - White
G626044 - Black



Extra-large shield eliminates power leakage through tracking. Accommodates Equine Fence and braid products.



Wood Post Heavy Duty Tape Insulator
G66913 - White
G669034 - Black

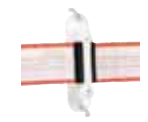

Soft rubber jaws lock 1.5" tape in place and prevent wear. Unique rubber pad eliminates tape wear.



Wood Post Corner Strain Tape Insulator

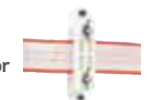

G670034 - Black w/steel plate

WOOD POST INSULATORS

Corner Lag Insulator
G679 - White
G688 - Black



This polycarbonate insulator with UV and color preservation is great for pulling through corners.



Large Porcelain Lag Insulator
G675



Long-life, fire resistant porcelain.



Standard Porcelain Lag Insulator
G671



Long-life, fire resistant porcelain.



Horse Tape Insulator
G668144 - White
G668044 - Black



Designed specifically for Poly Tape up to 1.5" wide. Staples to post and clamps to fiberglass.



SEE MULTI-PURPOSE INSULATOR ON PAGE 26

CLAMPS

Two options for clamping multiple HT wires in a secure electrical connection. Dedicated option for thicker wire/cable.

L Joint Clamp
Wing nut:
G603934 - 10 pk

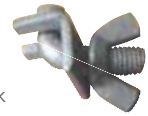

Joint Clamp
G603534 - 10 pk
G60355 - 25 pk



Hex nut:
G603034 - 10 pk
G603044 - 25 pk



WIRE CONNECTOR

Split Bolt Wire Connector
G605 - 5 pk



Connects high tensile or regular wire with jumper or lead-in wire.

Ensures good electrical connections.



Equine Fence Joiner
AH101



Join Equine Fence or 12.5 gauge wire without special tools or crimps. Simply strip special polymer coating off Equine Fence and insert bare wire into joiner.



26 Steel & Fiberglass Post Insulators

Steel Post Insulators

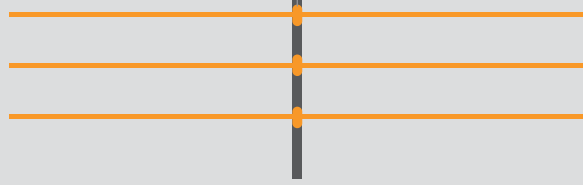

T-POST INSULATOR S

T-Post Universal Insulator
G682134 - White
G682434 - Green



Fits all T-Posts from 1.25" to 1.5". This unique snap on design requires no tools to install. The wide jaw accommodates Equine Fence and braid products.



T-Post 1.5" Tape
G654134 - White
G654434 - Green



Fits all T-Posts from 1.25" to 1.5". No tools are required to install. Specifically designed for .5"-1.5" tape. Will accommodate Equine Fence and braid products.



Steel Post Topper Insulator
G685134 - White
G685434 - Green



Safety and flexibility - add a single electric wire/tape/braid to the top of existing posts using this protective cap. Top accommodates .375" wire. Front accommodates 1.5" tape and .375" wire.



Benefits of Offset Fencing

Old fences can be made to last for many more years by simply attaching offset brackets and an electrified wire on one or both sides, even where fences have deteriorated so much that they need replacing.

New fences will last almost twice as long if they have electrified offset wires attached to them. Electrifying one or more wires in a conventional non-electric fence will prevent stock pushing through the fences.

Attach single offset wires at two thirds the animal to be controlled. If sheep and cattle are to be in the same area, use two wires or a single offset attached at three quarters the height of the sheep.

Where old barbed wire is rusty and broken, remove the worst wires and tighten the others to prevent an ongoing problem of them shorting out the offset wire. Old fence wires can also be connected in parallel and used as a ground return.



MULTI-PURPOSE INSULATOR



Multi-Purpose Insulator

G681134 - White
G681034 - Black

Heavy Duty, snap-on plastic insulator designed for steel posts, but can be nailed to wooden posts or screwed to vinyl posts.



IN LINE FIBERGLASS POST INSULATORS



Spring Grip Post Clip
A636



Clip for secure attachment to .375" fiberglass post.



Screw-on Rod Insulator
G65514 - White



For round posts for .25" to .625" in diameter.



Mistakes often made with an offset fence

Offset fencing is simple, quick and inexpensive to erect. It can be used easily and effectively for salvaging old fence, protecting a new fence or for a number of temporary purposes.

An offset electric fence is inexpensive and simple, yet some people insist on trying to make it even less expensive. There are two common mistakes made with an offset fence and together they completely destroy its effectiveness.

The most common error is the use of soft wire for the fence wire and for the offset bracket. High tensile wire should always be used for the fence wire and only spring steel wire for the offset brackets. The bracket must be able to spring back in place after impact or it will become entangled with the wire of the old fence and ground out.

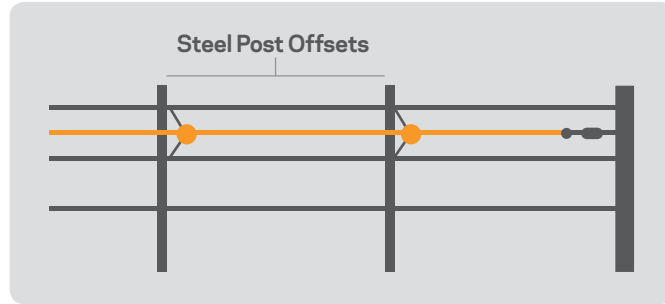
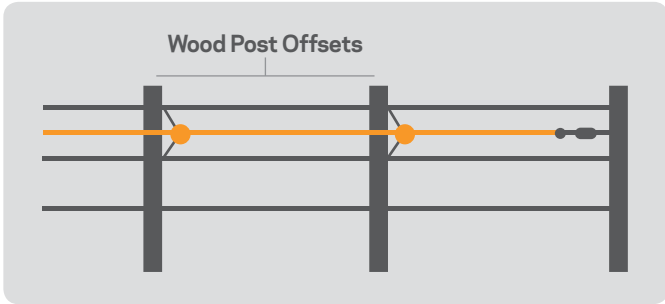

WIRE MOUNTED OFFSETS



Bracket Offset with Plastic Pinlock Insulator 12"

G665144 - White Replacements
 G665044 - Black Replacements
 G659034 - Black, 10 pk
 G659154 - White, 50 pk
 G659054 - Black, 50 pk

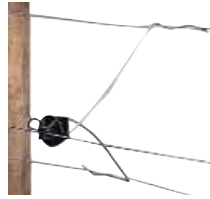

This offset will attach to any existing wire fence and comes pre-assembled.

Available with Porcelain insulator (G664054). Also, available for wood posts (G662054) and chain link (G653054).



The second most common mistake is the use of brackets that are too short, allowing the hot wire to remain too close to the fence it's attached to.

The placement/height of the hot wire is also very important. It should be attached at two thirds the height of the animal to be controlled. Two offset wires can and often are placed on the same fence. On one side a wire is placed at 30" to contain cattle and on the other side, a wire is placed at 8" to repel predators.

As simple as it is, offset fencing still must be viewed as a system. One shortcut or one sub-standard component can destroy the effectiveness of the fence.

PIGTAIL & WOOD POST OFFSETS



Popular option for adding an electric wire to existing wood post fences. Use side mount option for standard height or top mount for a higher top wire placement (e.g.: horses) and one or both sides of the post.

Pigtail Offset

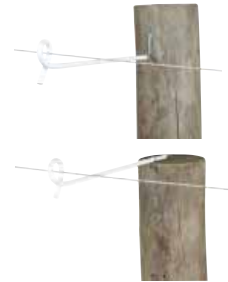

6.5" Side or Top
 G660214 - White
 G610224 - Black



Top Mount Double End Pigtail Offset



25.5"
 G610424 - Black



5" Offset Wooden Post Insulator

G617134 - White
 G617034 - Black



The pinlock allows for easy fence construction and wire removal. The wide jaw accommodates Equine Fence and braid products.



T-POST OFFSETS



T-Post 5" Offset Insulator

G650134 - White
 G650434 - Green



Extra locking tab enables offset to fit all T-Posts from 1.25" to 1.5". The pinlock allows for easy construction and wire removal. The wide jaw accommodates Equine Fence and braid products.



Universal 5" Offset Insulator

G694134 - White



This multi-purpose insulator is able to be attached to both sides of a steel post or nailed to a wooden post. It has a pinlock clip that allows for easy fence construction.



Ensure optimum power to all parts of the fence

Lead out describes the cable and wire that carries the power from the Energizer to the middle of your fence system. Much like your property water system, ensure optimum power distribution to all areas of your fence by choosing the most conductive cable/wire (biggest feeder pipe) relevant to your fence system.

DOUBLE INSULATED CABLE: Energizer to the fence



Insulated Cable
G609024 165'
16 Gauge



This double insulated cable has a resistance of 160 Ohms/mi.

High Conductive Cable
G62793 330'



This 12.5 gauge aluminium coated cable is ideal for long distances underground, through buildings or where there are numerous gateways in the leadout system. Three times the conductivity of 12.5 gauge galvanized wire.

Double Insulated Hard Cable
G627034 330' Black
G627014 65' Black
G627044 65' White



Made of 12.5 gauge steel and is ideal for standard leadouts and undergate cabling.

ELECTRIC FENCE WIRE: Fence to middle of system



High-Tensile Wire
A303 .5 mile



- Engineered and manufactured especially for permanent fencing. This 12.5 gauge wire is much stronger than standard fence wire and class III galvanized for longer life - 170,000 PSI.

Aluminium Wire



AXL17250 17 Gauge; 250'
AXL171320 17 Gauge; 1320'
AXL141320 14 Gauge; 1320'
AXL142640 14 Gauge; 2640'
AXL121320 12.5 Gauge; 1320'
AXL124000 12.5 Gauge; 4,000'

- Ideal for long leadout with very high powered Energizers. Never rusts; a permanent solution even in harsh environments. Conducts electricity four times better than steel wire.

Easy to re-spool and ideal for controlled grazing.

1/3 Weight of steel

WIRE ACCESSORIES:



Staples

AC680 1.75" Barbed Staples 10 lb pail
AC681 2" Barbed Staples 10 lb pail
AC683 1.5" Barbed Staples 10 lb pail



Wire Splicing Sleeves

A800 FW3-4 Wire Splicing Sleeve (10-11 Gauge Smooth)
A401 FW4-5 Wire Splicing Sleeve (9 Gauge Smooth)
A802 FW2-3 Wire Splicing Sleeve (12.5 Gauge Smooth)



Wire Line Taps

A405 FWT2-3 Line Tap (12.5 Gauge Smooth)
A811 FWT4-5 Line Tap (12.5 Gauge Barbed)



Using Insulated & Underground Cable

Leadout Cable or Double Insulated Cable should be used in buildings, under gateways and where soil could corrode exposed galvanized wire.

Undergate cables should not be used for long leadouts or for long distances underground, because the 16 gauge galvanized wire will cause resistance to the flow of the current. This is not so important on small properties, but where long distances of fencing are to be erected use 12.5 gauge Leadout Cable or High Conductive Cable.

Never use household electrical cable; it is made for a maximum of 440 volts and for inside work only.

Never use copper wire undergate cable because electrolysis problems occur where it is joined to galvanized fencing wire.



Conductor Selection Chart

				VOLTAGE AT BEGINNING OF FENCE	1,640' FENCE	6 MILE FENCE	RESISTANCE (Ohms/miles)	MIXED METALS*	INTERCONNECT*
Braid, Wire, Rope	A) Turbo Braid G62174 656', White G62176 1,312', White G621774 1,312', Green		<ul style="list-style-type: none"> 9 Mixed metal strands Most user-friendly for horse fencing - visible and safe Best suited for any distance temp or permanent fence 	8kV	7kV	6.3kV	155	▪	
	B) Turbo Wire G62054 656' G620564 1,312' G62089 2,624'		<ul style="list-style-type: none"> 9 Mixed metals Best suited to distances more than 1/4 mile, where extreme power is required 40 times more conductive than standard Poly Wire 	8kV	7kV	6.3kV	209	▪	
	C) Poly Wire G62004 656' G620300 1,640'		<ul style="list-style-type: none"> 6 Stainless steel strands Best suited for distances under 1/4 mile 	8kV	1.1kV	0.6kV	10,000		
.5" Tape	D) .5" Turbo Tape G62354 656' G62356 1,312'		<ul style="list-style-type: none"> Mixed metals 30x's more conductive Best suited for distances greater than 1/4 mile 	8kV	6.4kV	5.3kV	400	▪	▪
	E) .5" Poly Tape G62304 656'		<ul style="list-style-type: none"> 6 Stainless steel strands for good conductivity 	8kV	0.84kV	0.45kV	13,600		
1.5" Tape	F) 1.5" Turbo Tape * G624544 656'		<ul style="list-style-type: none"> 15 mixed strands for ultra high conductivity Reinforced edges for longer life & open weave for low wind resistance 	8kV	6.4kV	5.4kV	230	▪	▪
	G) 1.5" Poly Tape * G624044 656'		<ul style="list-style-type: none"> 15 Stainless steel strands Ideal for portable electric fences 	8kV	2.3kV	1.4kV	3,800		
Other	H) Equine Wire * G912064		<ul style="list-style-type: none"> Ideal for horse fencing - safe and effective Best for permanent fence - 12.5 g core Med tensile galvanized wire 10 Year warranty 	7.7kV	7.5kV		22		

* recommended for horses

30 Reels

Gallagher has a wide range of reels, portable posts and fence wires to make portable fencing easy and effective. Discover the best choice below to meet your needs.

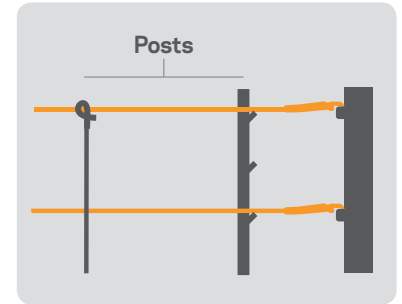
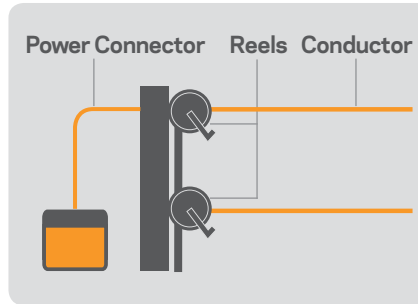

GEARED REELS

Geared Reel
G61150 (Note: Reel does not come pre-wound)

Securely attach to wire or ATV with locking device

Most popular option for fast winding (2.7:1) on standard length portable fences.

Approx. capacity: .31 mile Poly Wire, .25 mile Turbo Wire or .05 mile Tape.



Reels can be attached to galvanized Reel Stand (G63300)

Transport lock attaches securely to ATV or fence wire

Large Geared Reel
G63150

Larger capacity for bigger paddocks

Approx. capacity: .74 mile Poly Wire, .62 mile Turbo Wire or .25 mile Tape.



NON GEARED REELS

Lightweight & strong, for use on shorter, less frequently moved portable fences.

Medium Reel
G61100

Approx. capacity: .31 mile Poly Wire, .25 mile Turbo Wire or .05 mile Tape.



Small Reel
G63030

Ideal for small amounts of Poly Wire (.124), Turbo Wire (.09 mile) or Turbo Braid (.03 mile) such as camp corrals.



Econo Reel
G61600

.33 mile Poly Wire capacity or .25 mile Turbo Wire capacity.



REEL ACCESSORIES

Reel Stand
3' 1-3 reels
G63300



Rust resistant steel, tread-in post for holding up to 3 reels for strip grazing and temporary fencing. Includes chain for securing to a post.

Wire Guide
G61200



Reel guide replacement, for tangle free operation.

POWER CONNECTORS

UV resistant leads connect a portable fence to a permanent fence.

Single Reel Lead Connector
G634004



Tumblewheel

G63800

Enables you to quickly and easily roll a fence line to a new position. The Tumblewheel's unique center hub maintains power while the fence is being moved. It can also be used on flat, very hard and frozen ground. The legs remain live except for the two legs that are on the ground.

Where several breaks are needed in one paddock, Tumblewheels are ideal for quick and efficient rationing of grass. This fence consists of a number of electrified 'wheels' spaced across the pasture. Fences up to 660' and is easily managed from one end. 66' spacing of Tumblewheels is achievable on level ground.

The wheels are held upright with the tension of the single line fence which passes through the center. When one or both ends of the fence is moved, the wheels roll along. When you stop, the fence stops.

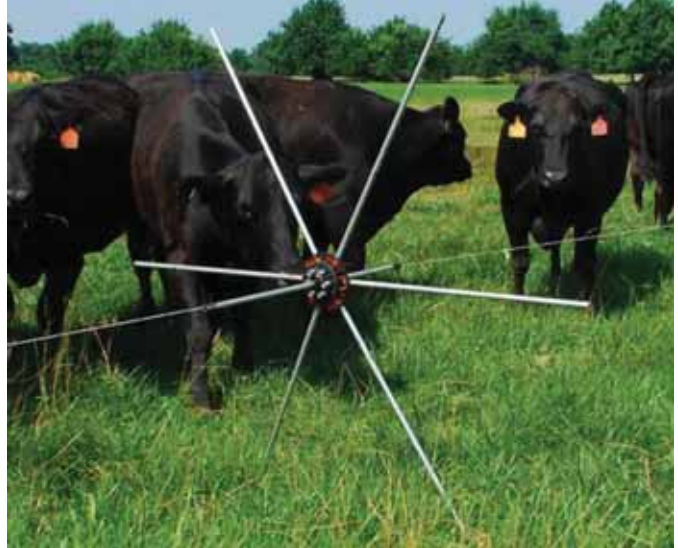

POSTS (All heights are from the foot)



Pigtail Standards – the most popular option for dairy & beef cattle

Standard Pigtail G64219

Ideal for softer ground, welded foot design reduces tangling.



Heavy Duty Pigtail G64245

Ideal for hard ground. 42" (including spike).

Crimped foot to ensure shaft strength.



Fiberglass Rod Post A635 - White G81433 - Orange

.375" x 48". Made of highly visible white fiberglass.

Use with A636 Quick Clip.



Multiwire Treadins – multiple lug positions for many animal types

Treadin Plastic Double Foot G72413

This very sturdy and durable plastic post is 42" high (including spike) with 9 numbered lugs designed for virtually all animal types.



Heavy Duty Plastic G636054 White G63655 Orange

UV stabilized plastic treadins with up to 9 lugs for positioning wires and tape.

42" high (including spike)



Ring Top Post G72315

No more tangled posts!

With a head that will not wear through, a super strong foot plate that will not bend under pressure and a sleek design that significantly reduces tangling, the Ring Top Post combines more strength with less frustration. 33" in height.



7/8" Fiberglass Fence Post

Use where a permanent fence post is required. Often used in feedlots or near buildings where animals may be pushed into the fence. These posts are pre-drilled every 2" for convenient wire spacings with exception of bottom 18" on FRP60, FRP66 and FRP72.

25 Year UV protection warranty.

AFRP48 - 48" AFRP66 - 66"
AFRP60 - 60" AFRP72 - 72"



Fiberglass Post Clips G70400

Made of galvanized, mild steel. Fast and easy design to use.



Fiberglass Stay Clips G70200

Made of galvanized mild steel. The tight tie prevents slipping.



32 Gate Kits and Gate Accessories

How to compare under gate cable

Choosing higher conductive under gate cable will ensure maximum power transfer between the two fence sections. Look for the lowest resistance rating per mile.

Soft cable is easier to strip while hard cable offers the best protection in the ground (note Gallagher recommends cable be installed through pipe for ultimate protection, especially in rocky ground).

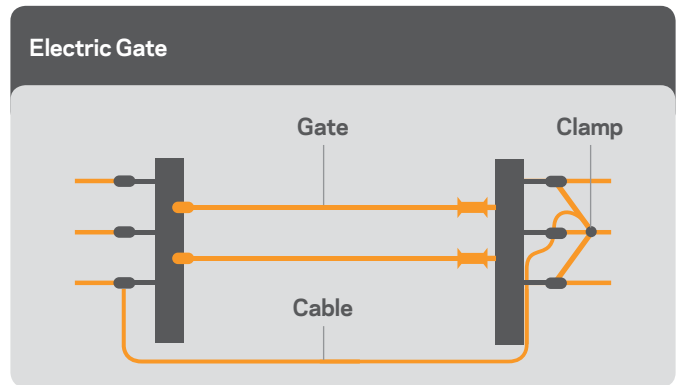

ELECTRIC GATE HANDLES

Heavy Duty Gate Handle
G639304



Flat hook for maximum electrification and extra safe handle which pulls out on impact. Heavy-duty tension spring.

Gate Handle
G691104
(White)



Large shield on handle to protect from shocks.

Gate Handle
G689404
(Green)



Highly visible green insulated handle. Large shield on handle to protect from shocks.

Insul-Grip
G606304



Insulated hook for quick and secure attachment of portable fences.



SINGLE STRAND KITS

All Gallagher gate kits include a high visibility flag.

Electric High Visibility Spring Gate
G64010



Highly visible electrified gate with insulated gate handle. Gate width is up to 16.5'.

Kit includes: insulator 3-way gate anchor, gate handle and all metal galvanized and powder coated spring.

Electric Tape Gate
G64100



White 1.5" tape and insulated gate handle for high visibility. Gate width is up to 16.5'. Includes stainless steel tape joiners.

Electric Bungy Gate
G64050



Highly visible shock cord that stretches to 11.5' to 23'.

Kit includes: insulator 3-way gate anchor, gate handle and bungy cord with UV stabilizer.

GATE ACCESSORIES

Multi Post 3-Way Gate Anchor
G649114



Super strong live anchor for up to three gates coming to a junction. Ideal for use in gateway systems at the intersection of multiple paddocks.

One-Hand Gravity Gate Latch
F0202U



Includes two staples and a 14" chain that is easy to attach and can be padlocked. Made from silver zinc passivate material.

GATE ACCESSORIES



Lock Through-Post Gate Hanger

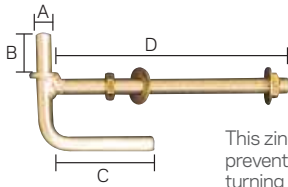

This zinc coated locking arm prevents the gate hanger from turning in the post.

	A	B	C	D
F0042U	.625"	1.625"	4"	10"
F0046U	.75"	2"	4"	14"

Through-Post Gate Hanger

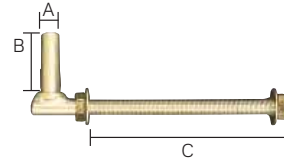

This zinc coated long pin (B) makes gate hanging easier by allowing the gate to slide down the long pin before engaging a short bottom pin. The long pin can be padlocked.

	A	B	C
F0023U	.625"	1.625"	10"
F0029U	.75"	2.75"	14"

Standard Strap Hinge
F0125U



Zinc coated strap hinge that measures .625" x 12".

Heavy-Duty Strap Hinge
F0132U



Zinc coated strap hinge that measures .75" x 15".

OTHER GATE KIT OPTIONS



Multi Strand Electric Tape Gate

G71802 2 Strand 26' (cattle)
G71804 4 Strand 26' (sheep)

A low cost, all-in-one permanent electrified gate option with multiple live strands, for practically any width gateway. It's easy to setup and use - open/ close with one hand.

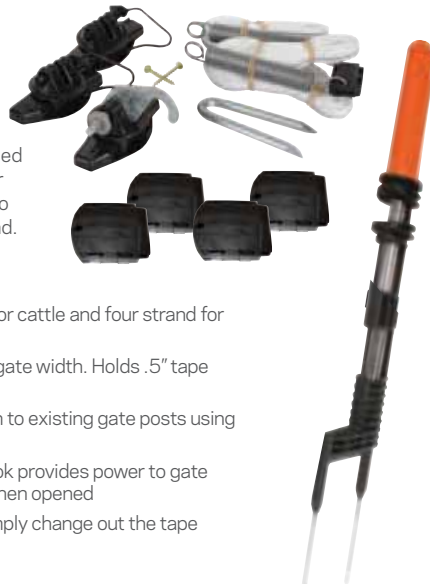

- Two or four strand option: Two strand for cattle and four strand for sheep
- Extendable tape lengths to fit desired gate width. Holds .5" tape (included) or 1.5" tape (clips included)
- Quick and easy to install. Simply attach to existing gate posts using supplied mounting hardware
- Simple, safe electrification as a live hook provides power to gate when closed and disconnects power when opened
- Easy to repair. If one strand breaks, simply change out the tape



34 Netting & Woven Wire



ElectroNet

A201000

- 35"x 164' Roll.
- 8 conductive horizontal wires.
- White plastic vertical struts every 12".
- Roll complete with all posts, just unfold and set the posts.
- Impenetrable mesh fencing for sheep, goats, coyotes and dogs.

Pos/Neg ElectroNet

A201200

- 35" Tall prefab fence with vertical struts every 12".
- 164' Long.
- For dry areas; good for sheep, goats and cattle.

Poultry Net

A207015

- 48" High prefab electrical fence with 12 horizontal lines.
- 164' Long.
- ½" Diameter white PVC posts every 8'.
- Double 6" spikes on each post for support.



Electra-Lock

Electrifiable Woven Wire Permanent Hi-Tensile Fence

A43024660 -4 Wire 30" High
A54024660 5 Wire 40" High

The cost savings are half of standard barbed wire construction.

This electrifiable woven wire fence comes in either 4 or 5 strands of hi-tensile, class 3 galvanized wire in 660' rolls. Specially designed lock knot holds vertical stays in place.

Installs with same corner and gate posts as standard barbed wire.

Recommended post spacing, depending upon terrain, is every 50' for 1 fiberglass post, 40' for wood posts and 25' for steel t-posts.



Smart Fence 2 G70000

A quicker and easier all in one instant fence system, the Smart Fence 2 re-defines portable fencing.

- Instant portable fence system
- Easy to carry and store away
- Highly effective safe animal control
- System includes 4 wires, 10 posts, 328' length
- Compatible with Gallagher Energizers - Energizer is not included



Horse Corral Kit

A155

A light weight (16 lb), complete in a bag kit for a 40' square corral. Quick and easy to assemble. Great for pack trips, horse shows or any event requiring a temporary enclosure.

- 1 B11 Energizer
- 1 Insul-Grip Gate Handle
- 1 Turbo Braid Spool
- 1 Ground Rod
- 10 Pigtail Posts



Garden & Backyard Protection Kit

A600

This kit is an easy do-it-yourself electric fence that fences a 50' x 50' area with three adjustable wires. It is a perfect fit for a residential consumer that is interested in an easy and affordable way to protect their garden, landscape or new plantings. Essentially tool-free and can be installed in 1 hour or less. Energizer operates on common 'D' cell batteries - no electric outlet or extension cord is used.

- 8 - 48" x 3/8" Fiberglass Posts
- 2 Bags 3/8" Clips
- 1 Poly Wire 656'
- 1 - 3' Ground Rod
- 1 B10 Energizer



36 Fence Setups

Once you've decided on the type of fence you'll need - permanent, offset or temporary - check below to find out the best fence set up for the animal you want to fence.

Cattle



Permanent

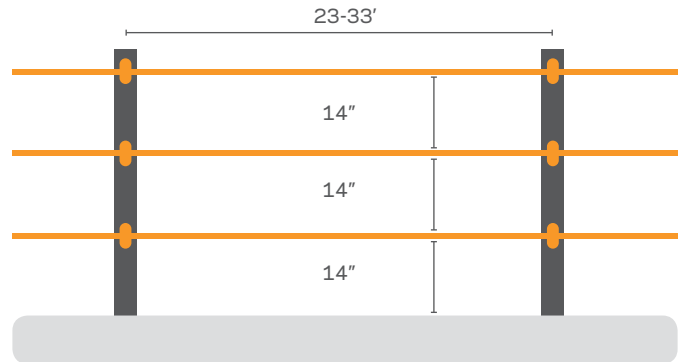

Pigs, Sheep, Goats

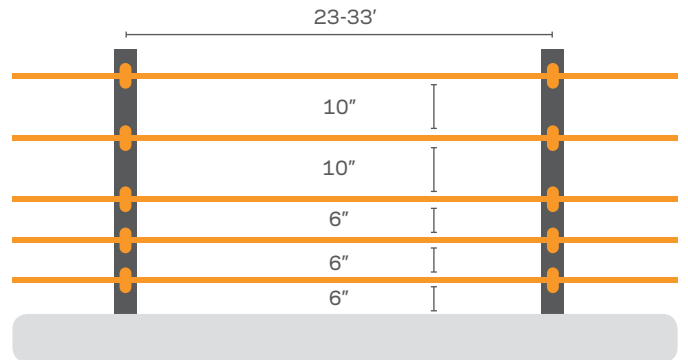

Horses

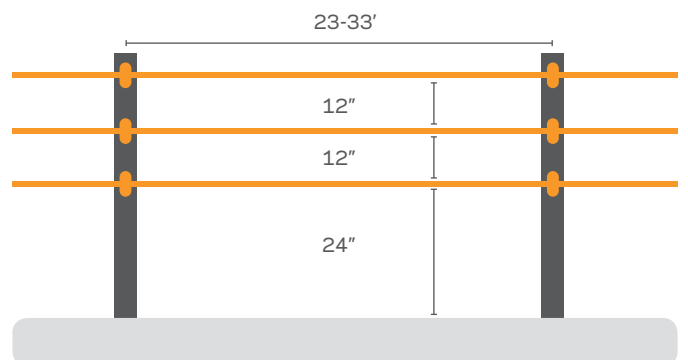
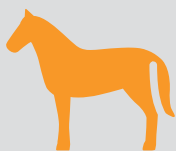

If you are fencing more than one type of animal, it is best to choose the fence set up recommended for the smallest animal - to ensure they can't get under the bottom wire.

Offset

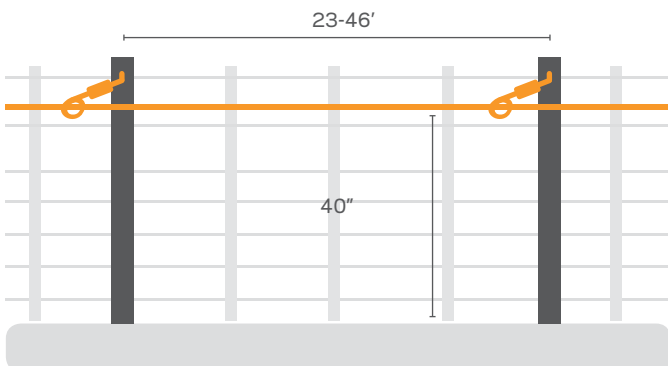
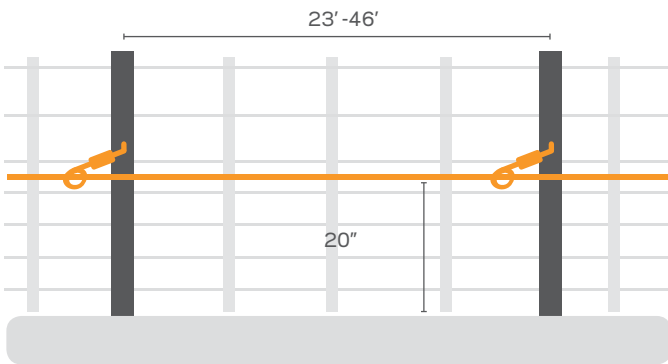
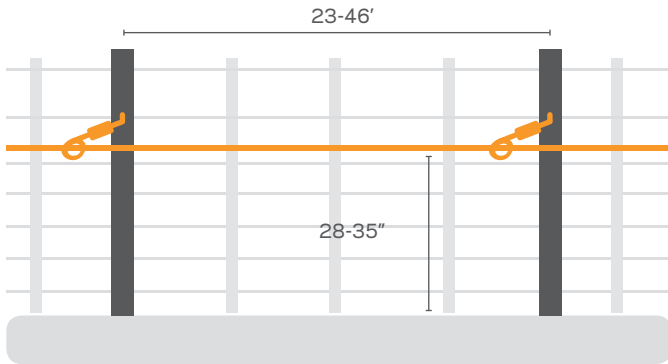

Temporary

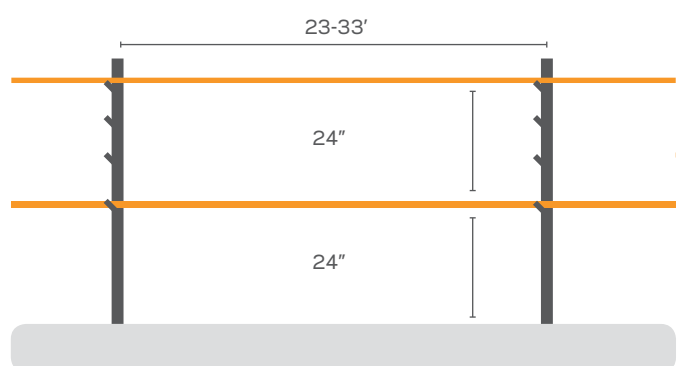
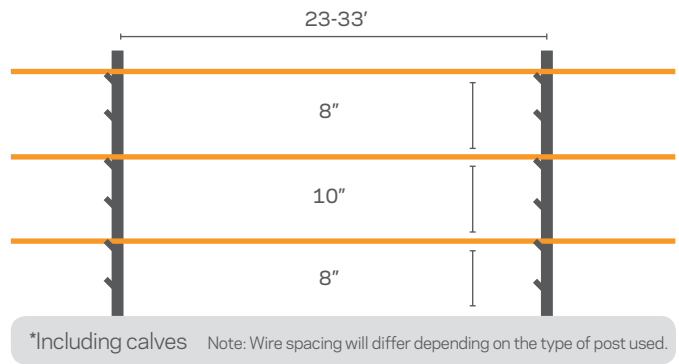
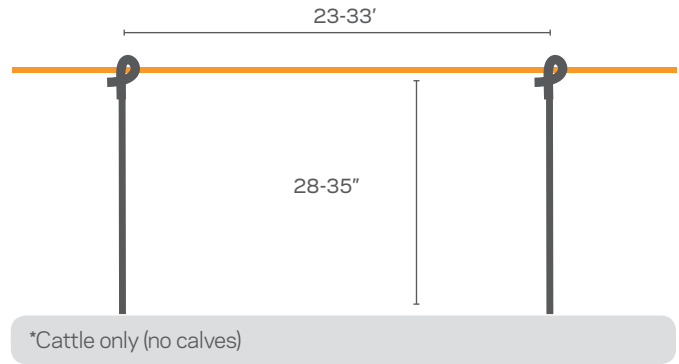

38 Fence Tools & Fence Accessories

FENCE TOOLS



Fencing Plier and Wire Cutter
G52200



Specifically designed for cutting, stripping and bending electric fence wire with minimum wire damage.

Strainer Handle
G69530



Spring loaded ratchet strainer handle for quick adjustment of wire strainers (fits most varieties of ratchet strainers).

In Line Wire Tightener Handle
A644



Tightener handle for Gallagher in-line wire strainers (G64304).

Ratchet Wire Tightening Tool
G645004



In line wire tightener handle with super smooth ratchet action, to be used with Gallagher in-line wire strainers (G64304).

Wire Twisting Tool
G523004



Ideal for installing clips on posts and droppers.

4 Groove Wire Crimping Tool
A609



20" Long 4-groove, robust tool for crimping wire joiners and splicing wire.

2 Groove Wire Crimping Tool
A609A



2 Groove, robust, tool for crimping wire joiners and splicing wire.

High Tensile Wire Cutter
G524



9" long high tensile wire cutter.

Poly/Turbo Wire Tensioner
AXLT8



Holds Poly Wire, Turbo Wire, .5" Poly Tape, .5" Turbo Tape and Turbo Braid.

Warning Sign
G602404



A highly visible sign that warns that a fence is electrified. Required by law, to be used on boundaries and anywhere else public have access to a fence.

FENCE TOOLS



Pay-Out Spinner
A308

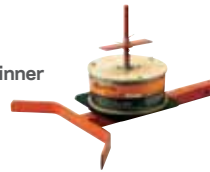

A necessity for building permanent fence. The adjustable break keeps wire from overwinding and it attaches to a 2" receiver.

H.D. Spinning Jenny
A309



Accommodates all standard wire sizes. Adjustable break keeps wire from overwinding.

Spinning Jenny
A305

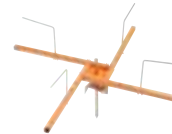

Accommodates up to a 100 lb. roll of wire.

Wire Payout Spinner
A304



Adjustable break keeps wire from over-winding. Handles 4,000' and 2,640' spool of hi-tensile wire or 1,000' of Equine Fence.

Pay-Out Spinner Conversion Kit
A307



Drill Chuck
G71300



Drill chuck for #G66604 Screw-In Ring Insulators.



Fence construction is made easy with Gallagher's range of durable, easy to use fence tools.

Gallagher Weighing & EID Systems

Features	W110	W210	W610 v2	W810 v2	TSi 2
OPERATION & DATA COLLECTION					
Manual and automatic weight locking options	▪	▪	▪	▪	▪
Assign visual tag against weight and EID number			▪	▪	▪
Calculates average daily weight gain and carcass weight			▪	▪	▪
Cross reference table capacity			12,000	21,000	1,000,000
Max number of weigh records			12,000	60,000	1,000,000
Individual animal notes and weight recorded			▪	▪	▪
Condition score recording			▪	▪	▪
Multiple custom trait definitions to collect and edit data				▪	▪
Review full animal history in the yard					▪
Manage treatments and associated withholding periods					▪
View animal pedigree information in graphical family tree					▪
Create custom data fields and calculations					▪
DRAFTING					
Liveweight drafting			▪	▪	▪
On screen drafting statistics recorded			▪	▪	▪
Automatic drafter interface			5-way	9-way	9-way
Drafting by electronic ID number				9-way	9-way
Draft based on Average Daily Gain (ADG) or custom calculations					▪
CONNECTIVITY					
Automatic load bar recognition & calibration	▪	▪	▪	▪	▪
Computer and printer interface			▪	▪	▪
Bluetooth connection to EID readers and drafters				▪	▪
WiFi connectivity					▪



W110
G01605

Entry level automatic weigh scale. Comes with loadbars.

W210
G012504

Entry level automatic weigh scale.

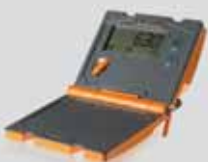

W610 v2
G01605

Entry level EID compatible weigh scale. Combines super fast weight locking with outstanding accuracy.



W810 v2
G01805

Advanced EID compatible weigh scale and data collector. Combines super fast weight locking with outstanding accuracy.



TSi 2
G01901

Most advanced weighing and data collection and management system available in the market today.



40 Entry Level Weigh Scales



Weigh Scale Indicator W110

G01605

Easy collection of weights for livestock & general purpose weighing

Includes Weigh Scale Indicator, Mount Bracket & Loadbars

- Tough construction for all weather outdoor use
- Battery powered convenience (4 x AA batteries sold separately)
- Plug and play system enables easy portability
- 0-1,500 kg/3,300 lb weighing capacity
- 2 Year warranty



Use Gallagher scales and electronic identification readers to maintain records and prepare your livestock for shows & competitions.



Battery powered - requires 4 "AA" batteries (sold separately)

Easy to use - modern design with large intuitive touch buttons

Flexible weighing options - three modes for weighing both static weights and livestock

Robust - loadbar connectors

Durable - protected cables to minimize damage in the yard/weighing site



Loadbars Precalibrated to indicator

Galvanized steel chassis construction for long life

Fits most sizes of platform with top-mounting holes

W210

G012504

Easy collection of weights for livestock & general purpose weighing

- Tough, shock and waterproof case
- Large labelled push buttons
- Large rotary dial
- Three weighing modes for quick and easy weighing: auto, manual and fine
- Compatible with most loadbars
- Internal rechargeable battery
- Large, easy to read display
- Simple operation



W210 Package

AG210

Entry level weighing system for producers. Get it all in one package deal!

Includes: W210 Indicator, Alleyway Loadbars, and Platform.

See page 44 for Alleyway Loadbar and Platform details.

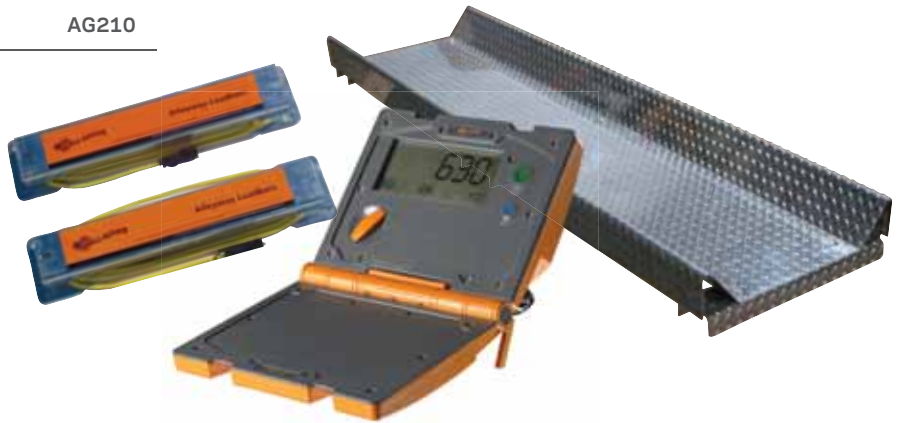

Weigh scales offer a quick return on investment, that is usually seen within the first year of installation.



42 Weighing, Data Collectors & Platforms

W610 v2

G01605

ALL THE WEIGH SCALE INDICATOR
W210 FEATURES PLUS:

- Second LCD screen for data display and statistics
- View weight gain, graphical displays and other options on graphics screen
- Direct interface to EID tag reader
- QWERTY keyboard for alphanumeric IDs, notes, etc.
- Supplied with APS PC software for easy download of records from, and upload of records to, the Weigh Scale Indicator
- Calculates average daily weight gain and carcass weight, assigns visual tag number against EID tag number and can assign up to 15 digit visual tag number against weight records and EID number

Entry level EID
compatible scale
indicator



- Draft statistics displayed while weighing for animal audit as well as draft category which is stored with animal record for later analysis
- Automated drafter interface to control 5-way drafting
- 2 communication ports for connection to computer and peripheral devices, such as animal drafters and EID tag readers

A Gallagher Weigh Scale provides producers with an innovative weighing system that is not only tough, reliable and accurate but also very simple to use.

W810 v2

G01805

Rapid, automatic, accurate weight capture.

Super long run time internal rechargeable battery with charge indicator and low voltage shutdown. (110v battery charger & 12 volt battery leads supplied).

Quick glance graphics screen to show weighing statistics and individual animal data entry (W810 v2 & W610 v2).

Smooth action rotary switch providing easy access to multiple weighing modes.

Large easy to use push button keyboard for alphanumeric data entry (W810 & W610).

Large and easy to read display screen. W610 and W810 screens are also backlit for poorly lighted areas.

Simple operation with large push buttons.

Simple connection - W810 has full Bluetooth wireless connection. W610 has communication ports for connection to computer, EID readers (with Bluetooth Adaptor G03203) and drafters.

Extra protection and transportation - Tough shock and waterproof case. 9.25" x 8.5"



FREE ANIMAL DATA TRANSFER APP
Transfer animal data using your W810 or W610 and Android/Apple Smartphone. Available FREE from Google Play or the Apple Store.



ANIMAL PERFORMANCE SOFTWARE (APS STANDARD INCLUDED)
Analyse data and upload data in three easy steps.

TSi 2

G01901

FASTER PROCESSOR MORE MEMORY IMPROVED SCREEN

An animal weighing and data collection system for improved livestock management and performance. The TSi 2 provides immediate access to detailed animal information, anywhere, at any time – in the sale barn, the office or on the ranch.

Intuitive software - Supplied with award-winning Animal Performance Software (APS Professional), for analysis and reporting to provide virtually any information you need.

Rugged exterior - Tough ranch/farm ready design for all-weather use.

Rapid, accurate, automatic weight capture.

Customizable sessions - Easily customize weighing and data recording sessions to collect specific traits, activities, notes etc.

Simple recording and retrieval - Collection of comprehensive data and retrieval of information at the touch of a button, while in the yard.

Exceptional connectivity - Bluetooth wireless connection and full integration with loadbars, EID readers, auto drafters and other management software.

Easily transfer data - WiFi enabled to allow upload of data directly to web and share with third parties.

Significant memory capacity - Entire life history of all animals stored for on-site viewing - over one million animal records can be stored.

Comprehensive drafting - Draft by weight, EID number or custom defined rules.

Touch screen - Full color outdoor readable touch screen with large touch buttons.

Bluetooth Communication and WiFi

Internal Battery

Loudspeaker

Audio Out

Power

USB Ports

Loadbar Connectors

RS232 Ports x 2



ANIMAL PERFORMANCE SOFTWARE (APS PROFESSIONAL INCLUDED)
Analyze data and upload in three easy steps.

Comes with carry case, memory stick and mounting bracket.
Dimensions: 14" (w) x 11" (d) x 3.5" (h) 29 lbs (excluding power supply)



44 Loadbars, Readers & Accessories

Alleyway Loadbars

G06000



- 4,400 lb weighing capacity in 23" length
- Rugged galvanized steel chassis
- Bottom feet-mounting holes extend beyond top covers for ease of bolting down
- Slotted top-mounting holes fit most sizes of platforms
- 19.6' long, tough polyurethane loadbar cables with spring wire protection
- Fitted with high quality, moisture proof connectors
- Fully water resistant
- No rubber mounts
- 2 Year warranty

Heavy Duty Loadbars

G06304



- 7,700 lbs weighing capacity in 39" length
- High capacity load cells are able to withstand large shock loads
- Heavy galvanized steel chassis construction to withstand the harshest environments
- Bottom feet-mounting holes extend beyond top covers for ease of bolting down
- 19.6', tough polyurethane loadbar cables with spring wire protection
- Fitted with high quality, moisture proof connectors
- Fully water resistant
- No rubber mounts
- Designed for a manual squeeze chute
- 2 Year warranty

Super Heavy Duty Loadbars

G06404



- All of the features of the Heavy Duty Loadbars but have 9,900 lbs weighing capacity in 39.3" length. These loadbars are made from galvanized steel and are powder coated
- Designed for manual chute or hydraulic chute
- 2 Year warranty

Heavy Duty Weigh Feet Kit

G05420



- Five tough, stainless steel weigh feet for easy mounting under cattle chute and custom platforms. One extra loadcell supplied in kit for easy replacement and no down-time
- 11,000 lbs weighing capacity
- Fast and easy loadcell replacement without major lifting
- High accuracy corner to corner performance for demanding weighing requirements
- Designed for manual chute or hydraulic chute
- Compatible only with 610, 810 and TSi

Aluminium Platform

G05900

- A high-strength platform designed to fit Gallagher 4,400 lbs. alleyway loadbars and most other branded loadbars
- Combine strength and portability to reduce the time and hassle involved in setting up weighing sessions
- Dimensions: 86.5" long, 24.5" wide; Platform weighs 49 lbs.

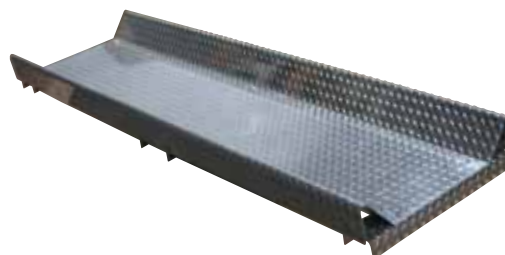

Smart Reader Electronic Controllers



G03113

- HDX and FDX-B, ISO and NAIT Tag compatible
- No antenna tuning required
- Can be used with either antenna panel below

R Series Electronic Controller

- Electronic controller for livestock identification
- Requires external 12 volt power source (not included)



G03111

BR Series Electronic Controller

- Battery powered electronic controller for livestock identification
- Internal rechargeable battery
- Easy to read battery charge indicator
- Internal memory stores 20,000 tags
- Tag counter display screen records animals scanned
- Download stored records to computer
- Replacement battery A728



Cattle automatically identified by BR Series as they enter the handler.



BR Series automatically provides ID number to Weigh Scale Indicator enabling accurate collection of individual sheep weights.



G031424

G03121

Smart Reader Panel Antennas

- Suitable for walk past identification applications
- HDX and FDX-B ISO compliant panel
- Waterproof antenna panel
- Mounting hardware supplied
- Can be used with either electronic controller above

Large Panel Antenna

Dimensions: 23.5" W x 51.5" H

Small Panel Antenna

Dimensions: 15.75" W x 23.5" H



Integrated BR Series and Weigh Scale Indicator system on cattle handler.

SCALE ACCESSORIES

20' Loadbar Extension Cables

- 4,400 lbs Loadbar (G05000)
- 7,716/9,900 lbs Loadbar (G05100)
- 20' long, tough polyurethane loadbar cables
- Fitted with high quality, moisture proof connectors



15' Double Antenna Cables

- Double antenna cables designed to link two panels to one reader.
- G05606 - Use with small and large antenna panels.



110V Adaptor 2M1695

Scale Bracket 4G2209

46 Readers & Data Collectors



HR3

G03301

- Create new sessions on reader to group tag reads from different pens of animals
- Compatible with Gallagher Android/Apple Animal Data Transfer App
- Internal memory for 5,000 tags for later download to computer
- Last tag scanned is displayed at power up
- Compatible with Gallagher Weigh Scale Indicators (models W610 and W810), the TSi and other brands of EID capable weighing and data collectors
- Built in Bluetooth communications for sending tag numbers to the other storage devices
- Supplied with software to download files and store sessions on computer



HR4

G03302

Easy recording of pre-defined animal data against EID tag numbers.

- Large display clearly shows visual ID and EID tag numbers to confirm the correct animal information is being collected
- Choose multiple traits to record against each animal such as breed, sex, condition score and pregnancy status
- Sort group name is highlighted on the screen for easy reference with optional group colors
- View past traits, activities and life data recorded against an animal
- Compatible with Gallagher Android Animal Data Transfer App

HR5 Hand Held EID Tag Readers & Data Collectors

HR5

G03303

Record, edit and customize on site. Includes all the features of the HR4, plus the following:

- Visual ID's can be added and used to identify and record information against an animal
- Link mothers with their newborns
- Add birthing details and data such as sex, birthing ease and fate
- Numeric, text date and pick list type traits can be entered
- Animal notes can be set to appear when the animal is next to be scanned
- Personalize session names making it easy to identify sessions once uploaded to APS software
- Compatible with Gallagher Animal Data Android/Apple Transfer App

ANIMAL PERFORMANCE SOFTWARE (APS) INCLUDED
Animal database software (APS Standard valued at \$199+TAX).



FAST and CONTINUOUS READING
Read multiple tags in quick succession with one trigger click - no need to repeatedly click the trigger between reads.

LED and BEEPER
Beeper sounds and super bright LED at end of snout flashes, to show tag read successful.

SIMPLE CONNECTIVITY
Easily connect via Bluetooth to other devices. Cables included for PC connection and to charge in-car.



LARGE EASY TO READ SCREEN
2.8" backlit color display with hi-resolution large graphics - easy to read indoors and out.



MARKET LEADING ERGONOMIC DESIGN
Comfortable soft grip handle, and ergonomically designed hand guard to reduce risk of trapping hand or arm in animal handler.



Sheep Auto Drafter

G05714

The Sheep Auto Drafter is a fully automated weighing and drafting system that is smoother, quieter and easier to set up and operate than any other sheep drafting product on the market. The Gallagher Sheep Auto Drafter includes the weigh crate, integrated load cells, integrated control module with remote control and three way draft module. Just add a suitable electronic weigh scale and you're ready to go!



Remote control operation - Unit can be controlled by one operator.



Flexible - Adjustable sides to handle small lambs to the largest rams.



High visibility control panel - Includes emergency stop button, auto/manual status & fault lamp.

48 Stock Prods & Accessories

Strong, safe and instant power for an effective, durable and inexpensive option to keep livestock moving, wet or dry.

Heavy Duty SG240 Two year warranty



Sealed replaceable motor

Moisture proof one piece handle

Balanced and comfortable hand grip

Safety wrist strap with button locking clip

Standard SG150 One year warranty



Safety wrist strap

Disposable batteries included

Stock prod shafts

32"
SG082



36"
SG091



42"
SG107



- Large attachment nut to help reduce breakages
- Brass contact points for positive results
- One year warranty

*Note: Length includes handle

54" Sorting Pole SG006

- Orange fiberglass shaft
- Heavy duty rubber tip
- Golf grip handle



48" Sorting Paddle SG007

- Noise makers inside
- Golf grip handle



Handy Shock SG001

- Only 9.4 ounces
- Pocket size
- Includes 4 "AA" batteries
- 1 Year warranty

**QUALITY
WATER
PROMOTES
LIVESTOCK
RATE OF GAIN**

Miraco Watering Tank Systems

Miraco has been offering healthy, clean, fresh livestock water systems to producers since 1974.



Miraco tanks can withstand cold temperatures without freezing



5 Year warranty offered on all Miraco Tanks



Poly construction makes these tanks durable. Multiple color options available on select tanks

Miraco perfected energy-free watering systems and was the first to manufacture automatic livestock waterers from poly materials. Join other livestock producers who enjoy the innovative features of Miraco Livestock Watering Systems.



E-Fount Waterers

E-Founts are the most economical electric heat waterers available today.

All E-Founts come equipped with a 75 watt heat element and thermostat. E-Founts only require 4 kilowatts of electricity during a week of -25 F temperatures.

MiraFount Waterers

MiraFount Tanks were the first livestock tanks in the world to be developed energy free. These innovative tanks have 2-3" of urethane insulation and have extra installation above the valve area. Water stays cool in warm temperatures and does not freeze in cold conditions.



Our real business is you.

50 Miraco Livestock Waterers

MiraFount A3390



Energy Free

Capacity: 150 head beef
60 head dairy

Gallons: 44

Specifications: Two 10" openings/
10.75" ball closures

Dimensions: 43"x 29"x 20" (L x W x H)

Weight: A3390 - 126 pounds (57 kg)
A3390-E - 129 pounds (58 kg)

Drinking Height: 20" (51 cm)

- Split top-end panels can be easily removed to help get new cattle started fast. Or, remove the panels to provide more capacity for a few extra head. Stainless Steel anchor bolts are included

E-Fount A3390-E



Energy Efficient
Heat Element: 75 Watts

MiraFount A3330



Energy Free

Capacity: 50 head beef
25 head dairy

Gallons: 15

Specifications: One 8.75" opening/9" ball closure

Dimensions: 28"x 26"x 14" (L x W x H)

Weight: A3330 - 59 pounds (27 kg)
A3330-E - 57 pounds (26 kg)

Drinking Height: 14" (35.5 cm)

- Stainless Steel anchor bolts are included

E-Fount A3330-E



Energy Efficient
Heat Element: 75 Watts

MiraFount A3465



Energy Free

Capacity: 100 head beef
40 head dairy

Gallons: 20

Specifications: Two 9.25" openings/10" ball closures

Dimensions: 36"x 24"x 18" (L x W x H)

Weight: 79 pounds (36 kg)

Drinking Height: 18" (46 cm)

- Stainless Steel anchor bolts are included

E-Fount A3465-E



Energy Efficient
Heat Element: 75 Watts

MiraFount A3345-S



Energy Free

Capacity: 75 head beef
30 head dairy

Gallons: 30

Specifications: One 10" opening / removable top

Dimensions: 29" x 31" x 18" (L x W x H)

Weight: 95 pounds (43 kg)

Drinking Height: 18" (46 cm)

- Stainless Steel anchor bolts are included

E-Fount A3345-E



Energy Efficient
Heat Element: 75 Watts

MiraFount A3354-S



Energy Free

Capacity: 200 head beef
90 head dairy

Gallons: 70

Specifications: Four 9.5" openings / 10.75" ball closures

Dimensions: 57.5" x 32.5" x 19" (L x W x H)

Weight: 152 pounds (69 kg)

Drinking Height: 19" (48 cm)

- Removable top-end panels help get new cattle started fast or provide more capacity for a few extra head

E-Fount A3354-SE



Energy Efficient Heat Element:
Two 75 Watt Heaters

MiraFount A3340



Energy Free

Capacity: 100 head sheep

Gallons: 15

Specifications: Four 6" openings / 7" ball closures

Dimensions: 28" x 26" x 14" (L x W x H)

Weight: 57 pounds (26 kg)

Drinking Height: 14" (35.5 cm)

- Stainless Steel anchor bolts are included

E-Fount A3340-E



Energy Efficient
Heat Element: 75 Watts

MiraFount A3410



Energy Free

Capacity: 100 market hogs
50 sows

Gallons: 6

Specifications: Two lift up lids / 10" openings

Dimensions: 34" x 19" x 16" (L x W x H)

Weight: A3410-E - 57 pounds (26 kg)
A3410 - 52 pounds (24 kg)

Drinking Height: Low drinking profile for small pigs

- Two large drain holes with rubber plugs for easy cleaning

E-Fount A3410-E



Energy Efficient
Heat Element: 75 Watts

MiraFount A3410-4



Energy Free

Capacity: 200 market hogs
100 sows

Gallons: 15

Specifications: Four lift up lids / 10" openings

Dimensions: 34" x 36.5" x 16" (L x W x H)

Weight: A3410-4E - 98 pounds (45 kg)
A3410-4 - 95 pounds (43 kg)

Drinking Height: Low drinking profile for small pigs

- Two large drain holes with rubber plugs for easy cleaning

E-Fount A3410-4E



Energy Efficient
Heat Element: 75 Watts

52 Miraco Livestock Waterers

MiraFount

A3370-S



Capacity: 250 head beef
120 head dairy
200 cow/calf units

Gallons: 100

Specifications: Six 9.5" openings/ 10.75" ball closures

Dimensions: 57.5"x 45.5"x 20" (L x W x H)

Drinking Height: 20" (51 cm)

Weight: 216 pounds (98 kg)

- Features removable end panels to help get new cattle started fast or to provide more capacity for a few extra head. Two valves are provided for fast recovery



Lil'Spring Tank Waterers

Features:

- One-piece body polyethylene construction
- No sharp edges
- Tough high impact resistant "Rockite" material to stand up to livestock abuse
- Resistant to corrosion
- Removable dome for quick and easy access to the valve area
- 2-3" urethane foam insulation
- Molded base unit anchors (stainless steel anchor bolts are included with all models)
- Sloped bottom for easy cleaning
- Sealed bottoms
- Color options are available
- Optional heater may be added

Lil'Spring

A2700



Capacity: 100 head sheep

Gallons: 6

Dimensions: 28.75" x 17.5" x 14"
(L x W x H)

Drinking Height: 14" (35.5 cm)

Weight: 40 pounds (18.15 kg)

Heat: Optional, 250-watt submersible heater (A160)

Lil'Spring

A2800

Capacity: 20 head beef
20 head horses

Gallons: 4

Dimensions: 20" x 16" x 27"
(L x W x H)

Drinking Height: 19" (48 cm)

Valve: Miraco automatic plastic

Weight: 40 pounds (18 kg)

Heat: Optional 110-volt, 250-watt submersible heater (A160)



- 200 psi hose w/shut off valve included
- Attractive design; five color options: Gray, Standard Blue, Black or Hunter Green

Lil'Spring

A2900

Capacity:	40 head beef 40 head horses
Gallons:	6
Dimensions:	30.5" x 16.5" x 27" (L x W x H)
Drinking Height:	19" (48 cm)
Valve:	Miraco automatic plastic
Weight:	48 pounds (18 kg)
Heat:	Optional 110-volt, 250-watt submersible heater (A160)



- 200 psi hose w/shut off valve included
- Attractive design; five color options: Gray, Standard Blue, Black or Hunter Green
- Anchor bolts are included



"I'm only interested in the best for my horses and Miraco watering systems are the best. These are strong, durable systems ergonomically designed to make it easy for the horse to get access to drink. Miraco products are also safe for the horse, and that's really important to me."

Curt Pate

World-renowned South Dakota horse trainer and clinician, film consultant and author

Recommended Installation Diagram

A 1" diameter line is recommended. The line should be buried 4' deep or 1' below the published frost line depth in your region.

Miraco recommends installing on a concrete platform that provides a 4-6" step and 18" around the perimeter of the unit. The concrete platform must be level to ensure optimal performance.

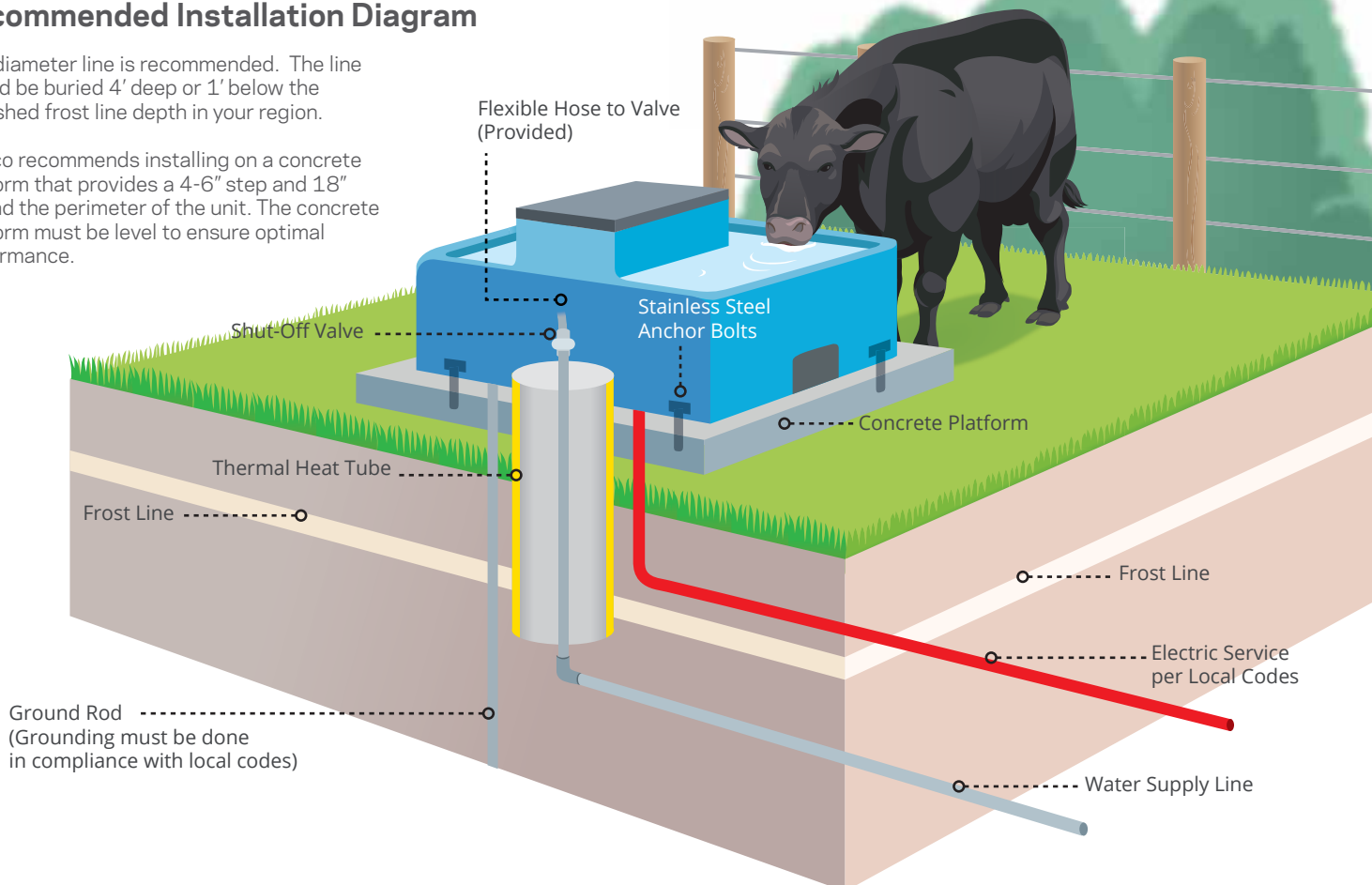

54 Miraco Livestock Waterers

Lil'Spring

A3000



Capacity: 30 head beef
30 head horses
50 head sheep

Gallons: 5

Dimensions: 24" x 22" x 21" (L x W x H)

Drinking Height: 24" (61 cm)

Valve: Miraco automatic plastic

Weight: 48 pounds (22 kg)

Heat: Optional 110-volt, 250-watt submersible heater (A160)

- 3" offset drain
- Bottom drain for inside use. 2" threaded fitting underneath for PVC plumbing
- Installs easily on most existing concrete pads.
- Stainless steel anchor bolts included

Lil'Spring

A3100DS



Capacity: 100 head beef
50 head dairy

Gallons: 8

Dimensions: 36" x 22" x 27" (L x W x H)

Drinking Height: 22" (55.8 cm)

Valve: Miraco automatic plastic

Weight: 75 pounds (34 kg)

Heat: Optional 110-volt, 250-watt submersible heater (A160)

Lil'Spring

A3200



Capacity: 150 head beef
75 head dairy

Gallons: 25

Dimensions: 48" x 24" x 29" (L x W x H)

Drinking Height: 24" (61 cm)

Valve: Miraco automatic plastic

Weight: 98 pounds (45 kg)

Heat: Optional 110-volt, 250-watt submersible heater (A160)

- Large access panel for easy access to valve area with spring load clips
- 3" offset drain
- Access panels at both ends
- Installs easily on most existing concrete pads
- Constant flow available
- Stainless steel anchor bolts included



Lil'Spring

A3500



Capacity:	225 head beef 110 head dairy
Gallons:	40
Dimensions:	42" x 42" x 26" (L x W x H)
Drinking Height:	26" (66 cm)
Valve:	Miraco automatic plastic
Weight:	145 pounds (65 kg)
Heat:	Optional 110-volt, 500-watt submersible heater (A162)

- 168" Drinking space
- Quick release valve access cover
- Diagonal valve compartment lets more cattle drink
- 24" hook-up hose with shut off valve
- Stainless steel anchor bolts
- 2 Bottom drains
- Teflon coated

EquiFount features smooth rounded edges for safety with minimum intrusion on stall space

**EquiFount Corner Mount**

A1100



Dimensions:
16" x 16" x 14"
(L x W x H)

EquiFount Wall Mount

A1200



Dimensions:
16" x 16" x 14"
(L x W x H)

Capacity:	1 Horse
Gallons:	1
Drinking Height:	26" (66 cm)
Heat:	Optional 110-volt, 250-watt submersible heater (A276)

- Smooth rounded edges for safety
- Durable 100% polyethylene construction; urethane foam insulation
- Easy valve access; one-screw, quick water level adjustment
- Four-bolt installation
- Plumb from above or below
- Ample drinking space; plentiful water supply with minimal waste
- Large easy drain; no disassembly required
- Attractive design; five color options: Gray, Standard Blue, Black or Hunter Green

EquiFount Insulated Ext Tube

A834-5



- Cold barns are not a problem for EquiFount waterers. This insulated extension tube allows water line to enter from below without freezing
- Rubber plug can be removed for access to water shut-off valve

56 Miraco Livestock Waterers

BigSpring Waterers are the preferred choice of cattle & dairy producers

BigSpring

A6000



Capacity: 250 head beef
100 head dairy
Gallons: 60
Dimensions: 90"x 33"x 24" (L x W x H)
Drinking Height: 24" (61 cm)
Weight: 215 pounds (97 kg)

- Optional 500 watt heater (110 or 220 volt - A162)
- Optional constant flow (30 or 60 gallon level)
- Water spray for attracting new cattle to water
- 3" (8 cm) drain hole with rubber plug for rapid cleaning
- Removable dome for easy access to valve area
- Spring-loaded clips - no wrenches required
- Rubber gasket for air-tight dome seal
- End panel access
- For cleaner water, neckrail to prevent cattle from standing in the water

BigSpring

A6100



Capacity: 110 head dairy
Gallons: 60
Dimensions: 80"x 36"x 24" (L x W x H)
Drinking Height: 24" (61 cm)
Weight: 205 pounds (93 kg)

- Optional 500 watt heater (110 or 220 volt - A162)
- Flat back design fits flush with the wall
- Center between stalls or place one on each
- Curved front for full, easy access - no wasted space
- Pour foundation with a curve for easier cleaning
- No wrenches required for valve compartment access
- Rubber gasket for air-tight dome seal
- Recommended installation on 10" concrete riser or with neck rail
- Optional gravity fill assemble available
- Stainless steel anchor bolts included
- For cleaner water, neckrail to prevent cattle from standing in the water

BigSpring

A6200

Capacity: 200 head beef
100 head dairy
Gallons: 60
Dimensions: 84"x 22"x 22" (L x W x H)
Drinking Height: 22" (56 cm)
Weight: 170 pounds (77 kg)

- Designed for free stall barns
- Flat back design for flush fit with a wall or panel
- Three access panels and no wrenches required for valve compartment access
- Two large 3" drains, severe slope for quick draining
- Rubber gasket for air-tight dome seal
- Optional 500 watt heater (110 or 220 volt - A162)



- For cleaner water, neckrail to prevent cattle from standing in the water
- Optional gravity fill assembly available

BigSpring

A6300

Capacity: 300 head beef
150 head dairy
Gallons: 110
Dimensions: 144"x 22"x 22" (L x W x H)
Drinking Height: 22" (56 cm)
Weight: 275 pounds (125 kg)
Heat: Optional 500 watt heater (110 or 220 volt - A162)



BigSpring

A6400

Capacity: 250 head beef
125 head dairy
Gallons: 90
Dimensions: 120"x 22"x 22" (L x W x H)
Drinking Height: 22" (56 cm)
Weight: 230 pounds (104 kg)
Heat: Optional 500 watt heater (110 or 220 volt - A162)

Water Tank Accessories

Hook Up Kits (A158) 2' rubber hose (200 psi) with shut off valve



Underground Shut Off Kit (A399-5) Comes with drain back

Insulated Heat Tubes (A834)

Outside Dimensions 14" x 30", Insulation is 2"
Weight: 16 pounds (7 kg)

Highly insulated tube shields incoming ground water from cold as it passes through the frost level. Polyethylene construction ensures years of trouble free use. One 20" tube and 3' of 12" plastic drainage tile provide sufficient heat in most locations. For northern locations two 30" heat tubes may be required.



Automatic Valves (A336)

GPM 14, Low pressure 5 - 40 psi

Automatic Valves (A521)

GPM 12.5, High pressure 40 -80 psi

Automatic Valves (A519)

GPM 6, Super high pressure 80 - 90 psi



Pet Waterer

A1000

- All polyethylene construction for easy cleaning
- No buildup of bacteria or algae
- Full polyurethane foam insulation
- 5 gallon reservoir - add ice during hot weather
- Bowl refills automatically - no moving parts
- Optional 250 watt heater assembly (A250)



Heaters, Cable & Floating Tank Valves

250 Watt Immersion Heater (A160)

Has a built-in thermostat 550
Teflon coated, 1-Yr Warranty

500 Watt Immersion Heater (A162)

110 Volt or 220 Volt
Teflon coated, 1-Yr Warranty



5' Cable Line Heater (A919-5)

8' Cable Line Heater (A919-8) - 110 Volt or 220 Volt

Gallagher .75" Water Tank Brass Valve with Float (AQ100B)



Gallagher .75" Water Tank Poly Valve with Float (AQ400P)



1" Water Tank Poly Valve with Float (AQ500P)

58 Icon Reference

POWER

- 12v battery included
- AA batteries included
- 9v battery included
- Rechargeable battery
- Rechargeable 12v battery
- Stored energy
- 12v battery powered
- Mains powered
- Battery not included
- Area powered
- Mains Power Adapter included /capable
- Mains/battery powered
- Solar powered/ solar capable
- Energizer Controller
- Remote included /capable
- Solar/12v battery powered
- LCD display
- Color
- Alarm capable
- Energizer
- Low power option
- Output voltage bar graph
- Battery life check
- Rechargeable 6v battery included
- Smartpac Remote included/capable
- XR1 Remote included/capable
- SMS capable
- Time saving
- Adjustable voltage
- Battery save options
- Battery save options
- Fence Monitor included/capable

CONSTRUCT

- Single foot
- Double foot
- Compression spring
- High visibility flag included
- Offset length
- Use on wood posts
- Use on T posts
- Use on steel posts
- Use on rod posts
- Use on concrete posts
- Use on steel treadin posts
- Use on high tensile wire
- Use on steel post

CONDUCT

- Wire diameter
- Length
- Reel gear ratio
- Stripes deter animals
- Tape width
- Height
- Cable wire diameter
- Insulated Handle included

Gallagher is committed to helping producers do and achieve more with educational clinics & many quality products that may be found at approved Gallagher dealers where you will always get professional advice and great support.

Drop in and visit your trusted Gallagher dealer. While you are there, be sure to ask about upcoming fencing and grazing clinics in your area.

You can locate your nearest dealer on our website at:
www.GallagherUSA.com



