

Installation Instructions

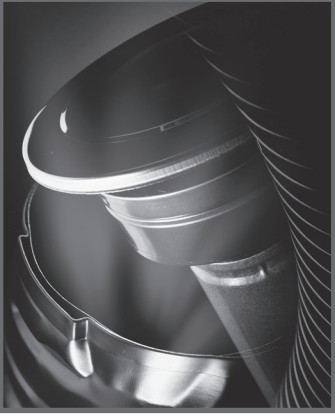

Pellet-fuel venting system.

PELLETTVENT[®]

DuraVent[®]

A MAJOR CAUSE OF VENT RELATED FIRES IS FAILURE TO MAINTAIN REQUIRED CLEARANCES (AIR SPACES) TO COMBUSTIBLE MATERIALS. IT IS OF THE UTMOST IMPORTANCE THAT PELLETVENT BE INSTALLED ONLY IN ACCORDANCE WITH THESE INSTRUCTIONS.

NOTE:

Read through all of these instructions before beginning your installation. Failure to install as described in this instruction will void the manufacturer's warranty, and may have an effect on your homeowner's insurance and UL listing status. Keep these instructions for future reference. This booklet also contains instructions for installing a venting system within an existing masonry chimney, and for installations passing through a cathedral ceiling.

Dear Customer, Installer, or End User:

We welcome any comments, ideas, input or complaints regarding matters pertaining to our DuraVent products.

If you are searching for tech support or product information, please call us at 800-835-4429.

Or email us at:
techsupport@duravent.com



MH8381, MH14420

VENTING SYSTEMS FOR PELLET FUEL

For the most up-to-date installation instructions, see www.duravent.com

CONTENTS

CLEARANCES AND APPLICATIONS 4
VENT LISTING, INSTALLATION NOTES 4
TOOLS AND EQUIPMENT YOU MAY NEED, PERMITS 5
GENERAL INSTALLATION INSTRUCTIONS 5
INSTALLATION INTO A MASONRY FIREPLACE 9
INSTALLATION THROUGH SIDE OF MASONRY CHIMNEY 10
INSTALLATION IN A CATHEDRAL CEILING 13
CLEANING AND MAINTENANCE 14
WARRANTY.....16

PELLETTVENT[®]

CLEARANCES AND APPLICATIONS

DuraVent's PelletVent is listed by Underwriters Laboratories as a vent for listed oil-, pellet-, (multi-fuel) appliances. PelletVent is also listed as a masonry reliner, in which case the minimum clearance is 0" from vent to masonry, and 0" clearance from the masonry to nearby combustibles. Never fill any required clearance space with insulation or any other materials (except insulation explicitly approved by DuraVent as noted below). Combustible materials include (but are not limited to) lumber, plywood, sheetrock, plaster and lath, furniture, curtains, electrical wiring, and building insulation except that noted below. The minimum clearance to combustibles from PelletVent is 1" for oil, pellet or other approved fuels. **A major cause of vent related fires is failure to maintain required clearances (air spaces) to combustible materials. It is of the utmost importance that double wall pellet vent be installed only in accordance with these instructions.**

NON-COMBUSTIBLE INSULATION

DuraVent approves the field application of non-combustible insulation within the clearance to combustible distance (in wall thimbles or support boxes) if/when desirable. Approved insulation must be listed / compliant with ASTM E136/ULC S114 as Non-Combustible, have a melting temperature above 2000°F/1100°C, be water resistant with low moisture absorption and be acceptable to the AHJ. Materials would include those made from stone (aka "rockwool" or "mineral wool" insulations). **NOTE- Fiberglass insulation is NOT approved!**

VENT LISTING

PelletVent is listed (MH8381 & MH14420) to UL 641 Type L Low Temperature Venting Systems, UL 1777 Relining, and ULC S609 Low Temperature Vents.

INSTALLATION NOTES

Proper planning for your PelletVent installation will result in greater safety, efficiency, and convenience, saving both time and money. Use only authorized DuraVent PelletVent listed parts. Do not install damaged parts.

- 1. WARNING:** When passing through ceilings and walls, make sure all combustible materials and combustible building insulation products are a minimum of 1" from the vent pipe.
2. When exiting through walls, make sure NFPA rules are followed for distance from windows and openings.
3. Do not mix and match with other products or improvise solutions.
4. Practice good workmanship. Sloppy work could jeopardize your installation.
5. Never use a vent with an inside diameter that is smaller than the appliance flue outlet.
6. Multistory: Where PelletVent passes through the ceiling, use an approved and listed Firestop/Support assembly.
7. PelletVent placement: When deciding the location of your stove and vent, try to minimize the alteration and reframing of structural components of the building.
8. Sections of pipe are connected to each other by pushing them firmly together and twisting. Screws are not required. If however, screws are desired, use 1/4"-long sheet metal screws. Under no circumstances penetrate the inner liner with screws.
9. 500 RTV Sealant may be required at all vent joints. Apply to inner female socket. Refer to Appliance manufacturer for further detail.
10. Never install single-wall pipe to freestanding pellet stoves. Single-wall pipe may be connected to a fireplace insert, provided it is inside the fireplace, and the fireplace has completely sealed surroundings.
11. Do not connect B-Vent pipe with aluminum liners to pellet appliances.
12. Inspections: Using pelletized fuel does

not eliminate the need for inspection and cleaning. During the heating season, inspect monthly, and clean at least once a year.

PERMITS

Contact your local building department or fire officials regarding any needed permits, restrictions, and installation inspection requirements in your area.

GENERAL INSTALLATION INSTRUCTIONS

PelletVent is listed with a minimum 1" clearance to combustibles. Refer to **Table 1** for framing requirements needed for these components.

1. Follow the stove/appliance manufacturer's instructions.

A. Choose an appliance that is listed by a recognized testing laboratory.

B. Connect only one flue per appliance.

C. Follow the appliance manufacturer's instructions and safety manual for maximum efficiency and safety. Overfiring can damage the appliance and vent.

2. If the vent exit is on top of the stove (**Figure 1**):

A. Place the appliance according to the manufacturer's instructions.

B. Drop a plumb bob to the center of the appliance flue outlet and mark center point on the ceiling, cut a square hole in the ceiling for the Ceiling Support Firestop Spacer. Refer to **Table 1** for the dimensions of the hole.

C. Connect Pipe Adapter to stove: Attach each section of pipe by pushing male and female ends of pipe together and twisting until pipe is in locked position.

D. When the pipe passes through the Ceiling Support Firestop Spacer at ceiling, tighten bolt and clamp around pipe.

E. Always maintain at least 1" clearance from combustible materials. Where the chimney passes through additional floors and ceilings, always install a Ceiling Support Firestop Spacer.

F. When the PelletVent enters the Attic, install an Attic Insulation Shield around the vent (**Figures 1 & 3**). This will prevent insulation and debris from collecting near the vent pipe. Use (4) wood screws to secure the base of the Attic Insulation Shield to the framed opening. Adjust the height of the Attic Insulation Shield by sliding the top cylindrical shield over the one from the base. Insure that the top of the Shield is above the level of building insulation. Secure the Shield in place with at least two (2) sheet metal screws through the side of the cylindrical shield. Attach collar around the top of the Attic Insulation Shield.

G. After lining up for the hole in roof, using the same method as 2.(B), cut either a round or square hole in the roof. Always cut the hole with the proper clearance to sides of Flashing under the roofing materials and nail to the roof along the upper edge. Do not nail across the lower edge. Seal all nail heads with non-hardening waterproof sealant.

H. To finish, apply high-temperature non-hardening RTV waterproof sealant where the Storm Collar will meet the vent and Flashing; slide Storm Collar down until it sets on the Flashing, put the Cap on and twist to lock (**Figure 2**).

3. If the flue exits on back of stove and an interior installation is desired (**Figure 3**):

A. Place the appliance according to the manufacturer's instructions.

B. Connect and seal a Pipe Adapter to the back of the stove and attach a Tee to Pipe Adapter, align, push together and twist to lock.

C. Continue to assemble pipe as described in **Step 2**.

4. If the flue exit is on the back of stove, and an exterior vertical installation is desired (**Figure 4**):

A. Place the appliance according to manufacturer's instructions.

B. Cut a square opening in the wall in accordance with the dimensions in **Table 1**. The black portion of the Wall Thimble is

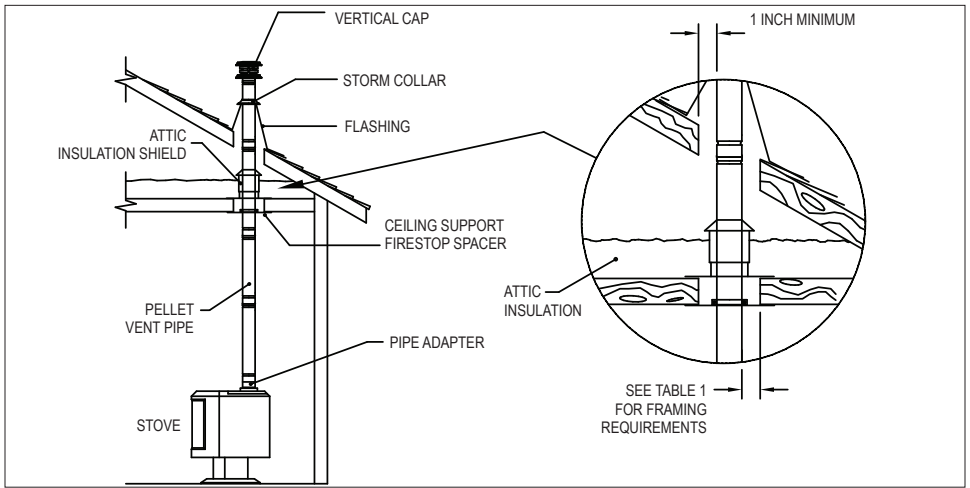

Figure 1

to be attached to the interior wall, and the galvanized portion is to be attached to the exterior wall. The Wall Thimble adjusts to fit walls from 3”-8” thick (**Figure 5**).

C. Connect a Pipe Adapter to back of stove; attach pipe to penetrate wall so vertical section from Tee will be 1” from the exterior of the wall. Attach a Single Tee or a Double Tee with Clean-Out Adapter, and proceed up the wall. Attach a Tee Support/Wall Strap just

above the Tee. A Tee Support/ Wall Strap must be placed every 4-feet along the vertical run. Assemble pipe in the same manner described in **Step 2** of the general instructions. If an Adjustable Length is required in the horizontal run, and the Adjustable Length must enter the Wall Thimble, the diameter of the center hole in the Wall Thimble must be enlarged by 1/8” to accommodate the Adjustable Length.

D. Seal the exterior section of the Wall Thimble to the wall with non-hardening waterproof sealant. As an option, you may also seal the gap between the pipe and Wall Thimble with sealant.

5. If the flue exit is on back of the stove, and a horizontal through-the-wall installation is desired (**Figure 6**):

A. Place the appliance according to manufacturer’s instructions.

B. Connect the Pipe Adapter to back of stove and attach sufficient pipe to penetrate Wall Thimble and extend at least 6” beyond the exterior wall. You may install the optional House Shield as shown in **Figure 6**. The House Shield is used to protect the exterior wall from vent discharge. Attach a Square or Round Horizontal Cap. The Round Horizontal

Table 1

Vent Component	Framing Dimensions
3” & 4” Ceiling Support / Firestop Spacer	7 1/4” x 7 1/4”
3” & 4” Cathedral Ceiling Support Box	10-3/4” x 10-3/4”
3” & 4” Wall Thimble (9” square plate version)	7 1/4” x 7 1/4”
3” & 4” Wall Thimble (13” square plate version)	10 3/4” X 10 3/4”

Cap can be swiveled to be directed away from nearby objects (fence, plants, etc.), but must still be pointing in a generally downward direction. Important: Horizontal Caps must be pointed in a generally downward direction to insure rain and snow do not enter the cap, and cause potential damage to the appliance. Either vent Cap should be at least 6" from the wall.

C. Follow the appropriate code for proper distance of exit terminal from windows and openings- NFPA 211 (2010 ed.) Section 10.4 Termination: 10.4.5 (1) The exit terminal of a mechanical draft system other than a gas-, oil- or pellet-fired direct vent appliance (sealed combustion) shall be located in accordance with the following:

- (a) Not less than 3 ft (.92m) above any forced air inlet located within 10 ft. (3m).
- (b) Not less than 4 ft. (1.2m) below, 4 ft. (1.2m) horizontally from, or 1 ft. (305mm) above

⚠ WARNING

WARNING: Do not install any combustible insulation or other non-approved material inside the Wall Thimble. Doing so can create a fire hazard. If desired, reference approved non-combustible insulation requirements detailed earlier in this text.

any door, window or gravity air inlet into any building.

- (c) Not less than 2 ft. (0.61m) from an adjacent building and not less than 7 ft (2.1m) above grade when located adjacent to public walkways.

6. If it is desired to attach to an existing 6", 7" or 8" DuraTech, DuraPlus or DuraChimney chimney, either roof supported, or ceiling supported: **(Figure 7).**

A. Remove any existing connector pipe,

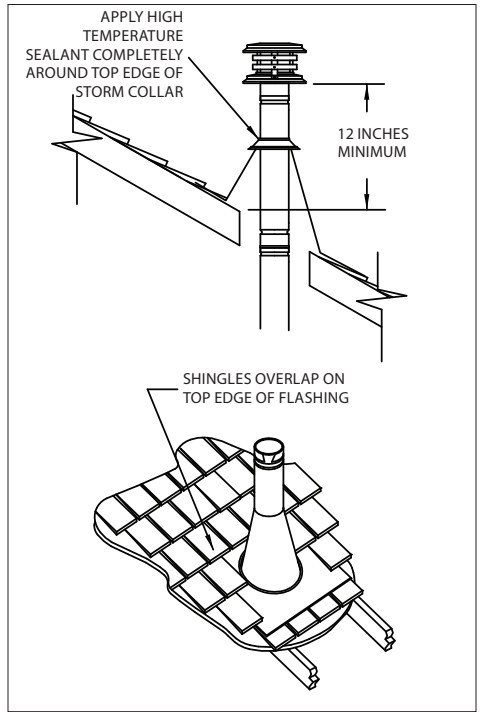

Figure 2

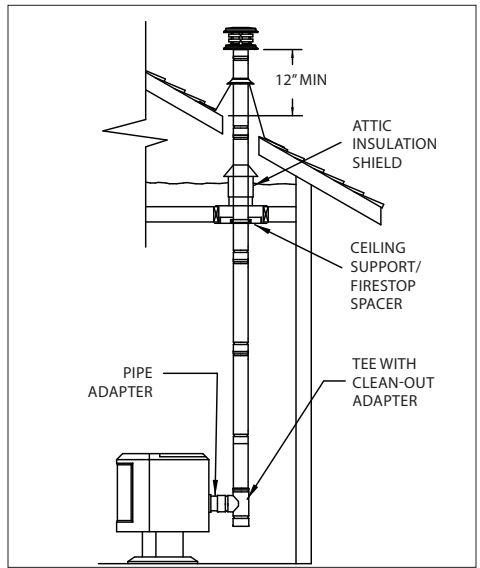

Figure 3

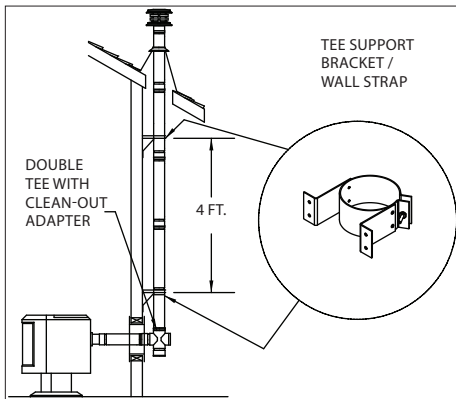

Figure 4

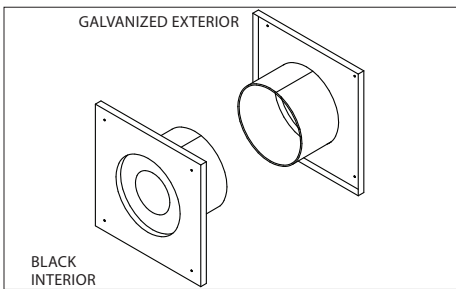

Figure 5

adapter or connector going into the Ceiling Support Box.

B. Visually inspect with a flashlight the condition of the interior of the chimney for cleanliness and structural integrity. All evidence of soot and creosote must be removed from the existing chimney system. If you doubt your ability to accomplish this, contact a certified chimney sweep. Do not use chemical cleaners, as these can possibly damage the inside of the chimney. Do any required maintenance on the existing chimney system at this time.

C. Install a DVL/DuraBlack Chimney Adapter in the existing ceiling support box, as shown in **Figure 7**. Note that the DVL/DuraBlack Chimney Adapter only connects to DuraVent chimney systems.

D. Connect and seal the appropriate size

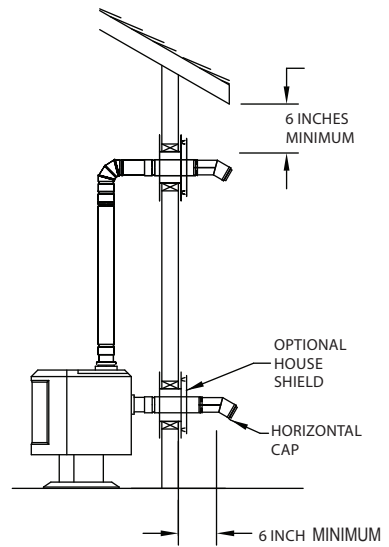

Figure 6

Chimney Adapter to the DVL/DuraBlack Chimney Adapter.

E. Connect the appliance to the Chimney Adapter using a Pipe Adapter, lengths of pipe as required, and an Adjustable Length pipe. Slide the Adjustable Length down over the top pipe section, position the installation vertically plumb, then slip the Adjustable Length up and twist lock it to the Chimney Adapter. Once all the components are firmly seated and properly aligned, carefully drill three 1/8" diameter holes through the outer sleeve only in the center of the slots located at the bottom of the Adjustable Length pipe. Do not penetrate the inner liner. Use (3) 3/8" length sheet metal screws to secure the Adjustable Length pipe. The completed installation will look like

Figure 7.

INSTALLATION INTO A MASONRY FIREPLACE

1. Have the masonry chimney inspected by a certified chimney sweep or installer, to

determine its structural condition.

2. Carefully read the pellet stove or insert installation instructions.

3. Measure and record the dimensions as shown in **Figure 8**.

4. Use dimension "A" to determine total pipe requirements. Add 12 additional inches to insure the termination is an adequate distance above the roofline.

5. The gross pipe required will be "A" dimension plus 12". Five feet of this will be Flex Pipe. The remainder will be rigid pipe. For each joint, subtract 1-1/2" to allow for the overlap. You may need extra pipe, or an adjustable length pipe section to achieve the correct height.

6. Assemble the first rigid pipe section to the Flex Pipe, insuring that the "UP" arrows shown on the pipe labels are, in fact, pointing up. Push the sections together and twist to lock. Screws are not required for a firm lock, however, should it be desired to use them, use stainless steel sheet metal screws 1/4" long - DO NOT penetrate the inner liner of the pipe.

7. Repeat this process for the remainder of the pipe sections, and lower the assembly down the chimney as shown in **Figure 9**. Lower it below its normal position in order to connect the Flex Pipe to the pipe on the appliance. It may be necessary to tie a line to the top section, to pull it back up later.

8. In making the connection at the appliance, configurations other than the one shown in **Figure 10** may be made. It may be necessary to contact the manufacturer of the unit to determine exactly what may or may not be done to make the correct connection. Some typical arrangements are shown in **Figures 11 and 12**. A Pipe Adapter may be needed, depending on the exit size of the stove or insert collar.

9. If a Tee is necessary to make the connection, as shown in **Figure 12**, the Tee has a removable Clean Out Adapter on its base to enable cleaning. The Tee Support

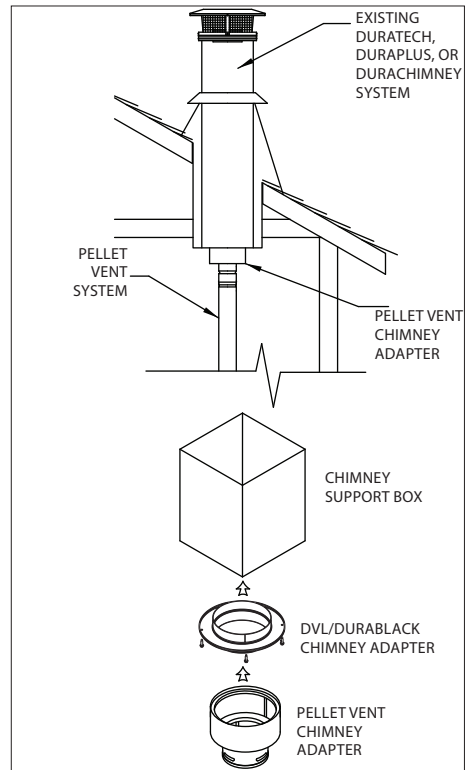

Figure 7

Bracket to hold the Tee to the rear of the appliance is mandatory. If it is desired to mount the Tee Support to the rear of the stove, obtain approval from the manufacturer of the stove before drilling, tapping, or performing any other alterations to the appliance.

10. Connect the appliance to the coupling on the bottom of the Flex Pipe, by twisting to the locked position. Push the appliance into the fireplace to its final resting place. Go to the top of the chimney and pull the vent system up to its desired height.

11. For the termination of the pellet vent, you will use a Tall Cone Flashing, and a Storm Collar. This will require 14" of pipe above the top of the masonry chimney. Pull the pipe up

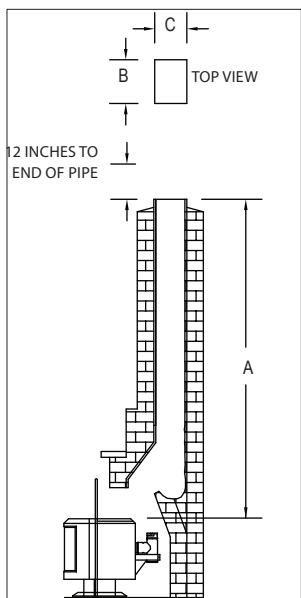

Figure 8

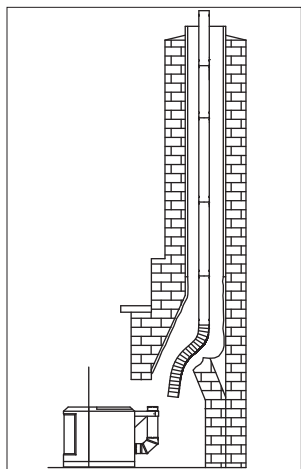

Figure 9

through the flashing to the desired height. Mark where the Storm Collar will go. Slip the Storm Collar down over the pipe, and affix it to the pipe with a 1/4" long stainless steel sheet metal screw. (**Figures 13 & 14**). The Storm Collar will then support the entire vent system. Install the Cap. Seal the joint at the Storm Collar, and any other joints or seams which may appear suspect. **Figure 15** shows a Tall Cone Flashing modified to fit a chimney where the tile liner protrudes above the masonry, as another alternate termination technique. This completes the masonry installation.

INSTALLATION THROUGH SIDE OF MASONRY CHIMNEY

1. Set the appliance in its final location and mark the center of the hole where the pipe is to penetrate the masonry chimney (**Figure 16**). Insure that you comply with the manufacturer's specifications in regards to clearance and distances from combustible surfaces.
2. The pellet vent system is assembled essentially the same as previously described for installation in an existing masonry chimney with the exceptions listed:
 - A.** No Flex Pipe is required, unless the masonry chimney has an offset. If an offset exists, then a section of Flex Pipe will be needed to accommodate the offset.
 - B.** A Tee is installed at the bottom end of the vertical pipe (**Figure 16**).
 - C.** A Reduction Collar or a Trim Collar is required to go around the pipe section that passes through the masonry to give it a finished look (**Figure 16**).
3. It will be necessary to break out the masonry around the location of the pipe center line mark to a diameter of at least 4" for 3" pipe, and at least 5" in diameter for 4" pipe.
4. Install the Tee on the bottom of the vertical pipe system and lower it down the chimney until the center of the branch of the Tee

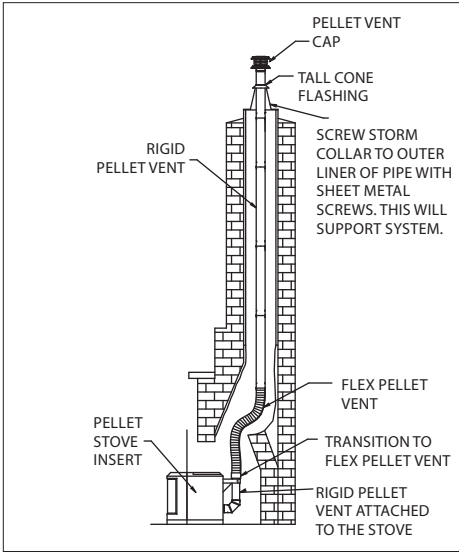

Figure 10

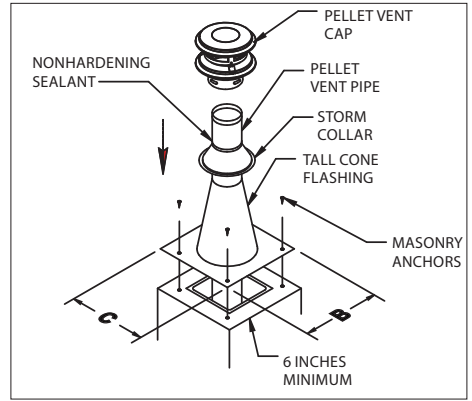

Figure 13

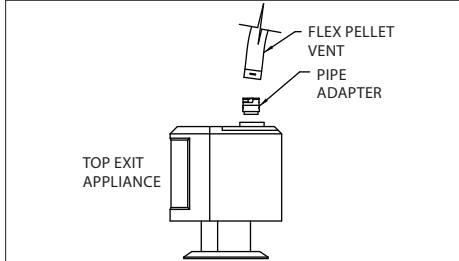

Figure 11

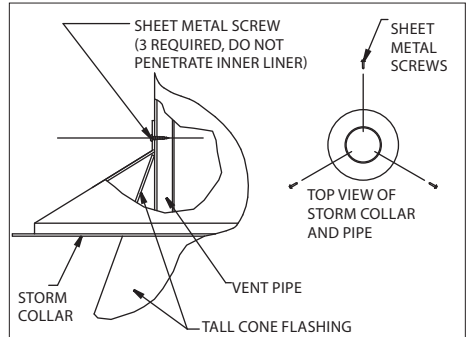

Figure 14

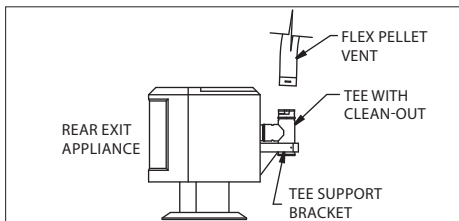

Figure 12

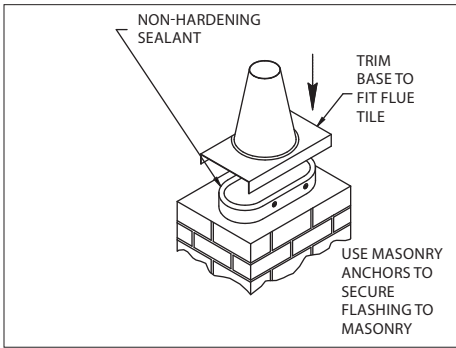

Figure 15

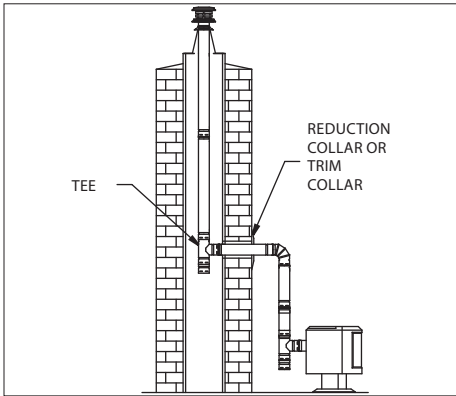

Figure 16

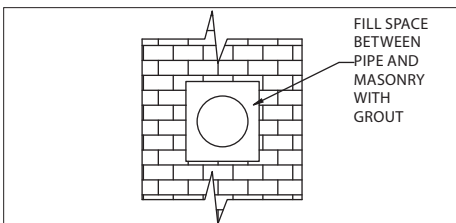

Figure 17

is level with the center of the hole in the masonry. Connect horizontal pipe section to the Tee branch.

5. Holding the pipe at the proper elevation, install the Storm Collar and Cap, as described in **Step 11** for the fireplace installation.

6. Connect the horizontal piece of pipe which goes through the masonry to the Tee by pushing it through the hole in the masonry, and lining it up with the branch of the Tee. Then push it into the Tee, while twisting to lock it.

7. Once the horizontal pipe section is in place, the space between the pipe and the masonry may be filled with high temperature grout, as shown in **Figure 17**, if desired.

8. Install the Reduction Collar or Trim Collar, the 90° Elbow, and the vertical pipe section going to the appliance. An Adjustable Pipe length will probably be needed, as well as a Pipe Adapter.

9. Conduct a final inspection of the entire job, and review the manufacturer's operating and installation instructions once more, before firing the appliance.

INSTALLATION IN A CATHEDRAL CEILING

1. Mark a line on the side of the Cathedral Ceiling Support Box to correspond to the line of the roof pitch, as shown in **Figure 18**. Allow for the Support Box to protrude below the low side of the finished ceiling a minimum of 2".

2. Position the appliance at its proper location on the floor. Pay close attention to the manufacturer's installation instructions regarding the distances from combustibles, etc. The appliance must also be positioned so the Support Box will not interfere with roof rafters or other structural framing.

3. Run a plumb line from the center of the flue exit on the stove to the ceiling. Mark the

point on the ceiling where the plumb line intersects. This represents the center of the support box. Drill a small hole through the ceiling at this point, so it can be located from the top of the roof.

4. From the roof, locate and mark the outline of the Support Box.

5. Remove shingles or other roof covering as necessary to cut the rectangular hole for the Support Box. Cut the hole 1/8" larger than the dimensions of the Support Box. (**Figure 19**). The rectangular hole should be centered on the small hole which you drilled through the ceiling to mark the location. Again, verify that you are not cutting through rafters or framing members.

6. Run the Support Box through the roof as shown in **Figure 20**, and place it so that the bottom of the Support Box protrudes at least 2" below the finished ceiling. Align the Support Box vertically and horizontally with a level. Temporarily tack the Support Box in place through the inside walls and into the roof sheathing.

7. Using tin snips, cut the Support Box from the top corners down to the roof line, and fold the resulting flap over the roof sheathing (**Figure 21**). Before nailing it to roof, run a bead of non-hardening sealant around the outside top edges of the Support Box so as to make a seal between the box and the roof. Clean out any combustible material or debris from inside the Support Box.

8. Place the Pipe Clamp, (which comes as a component of the Support Box) around the top of the hole in the bottom of the Support Box (**Figure 23**).

9. Connect the necessary amount of pipe sections to reach the stove at a point where the Cap will be at least 12" above the roof (**Figure 22**).

10. Run the assembled pieces of pellet vent pipe down through the Clamp of the Support Box and connect to the appliance with a Pipe Adapter. Using a level, make slight adjustments in the position of the appliance

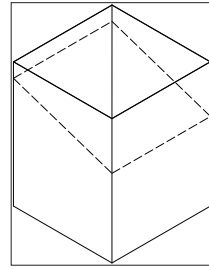

Figure 18

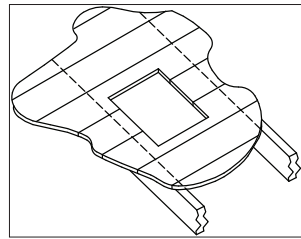

Figure 19

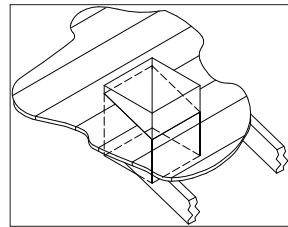

Figure 20

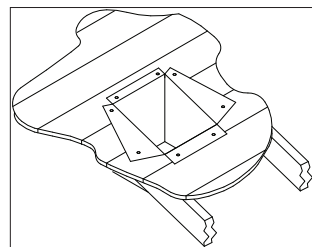

Figure 21

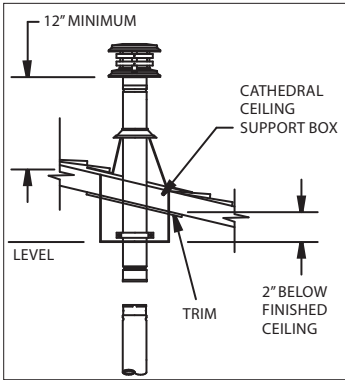

Figure 22

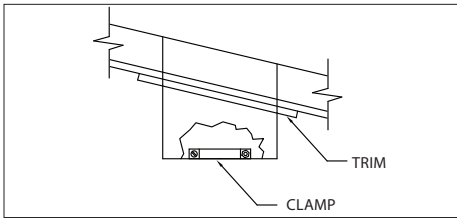

Figure 23

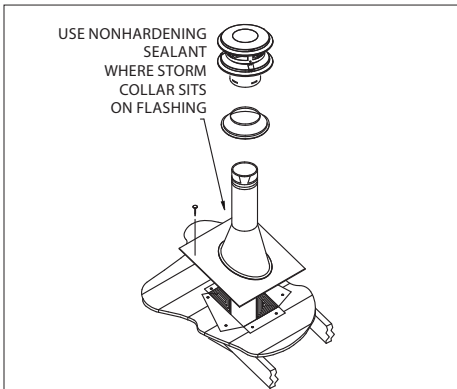

Figure 24

until the pipe is truly vertical. Tighten the bolts in the Clamp. Note that the overall length of the pellet vent pipe as assembled, can be no longer than 42 feet.

11. Slip the Flashing over the pipe section(s) protruding through the roof. Secure the base to the roof with roofing nails as shown in **Figure 24**. Insure that the roofing material overlaps the top edge of the Flashing (**Refer to Figure 2**).

CLEANING AND MAINTENANCE

- 1.** Have your system cleaned by a certified chimney sweep if you have doubts about your ability to clean it. Use a plastic or flexible steel brush. Do not use a stiff brush that will scratch the stainless steel liner of your system.
- 2.** PelletVent systems must be installed so that access is provided for inspection and cleaning.
- 3.** The pellet vent should be inspected at least once every month during the heating season.
- 4.** Do not use chemical cleaners. They can damage the vent pipe.
- 5.** To increase pellet vent life, coat all exterior metal parts with high temperature, rustproof paint. This is highly recommended, particularly in areas near the ocean.
- 6.** In case of a chimney fire, close all appliance draft openings, shut off pellet appliance and call your Fire Department. Do not use the appliance or vent until it has been inspected for possible damage.
- 7.** DuraVent is not responsible for flue by-products that might discolor roofs or walls.

Fuel: Be sure to follow the recommendations of the appliance manufacturer for the type of fuel to use.

Vent Runs: Condensate is more likely to form in longer vents because the exhaust temperature cools further away from the appliance. If the exhaust cools to a certain

point, moisture in the exhaust condenses in the vent, which can lead to accelerated vent corrosion. Maintain hot flue gas temperatures. It is recommended that the vent run inside the building envelope or inside a chase enclosure to minimize the vent's exposure to cold temperatures. Be sure to follow all-applicable building codes and the requirements of the vent and appliance manufacturers.

Appliance Operation: Always operate your appliance in accordance with the appliance manufacturer's recommendations. However, operating the appliance at its lowest setting has a greater chance for condensate to form in the vent due to the low exhaust temperature. In order to help reduce condensate from forming inside the vent system, operate the appliance at higher temperatures when colder weather is encountered. Higher operation settings provide for warmer flue temperatures, which help to keep moisture suspended in the flue gases.

Inspection and Maintenance: Be sure to inspect the appliance and vent often to determine if there has been any corrosion or damage to the system. Be sure to keep the venting system clean, including the tee cap (if applicable).

M&G DURAVENT LIMITED LIFETIME WARRANTY

M&G DuraVent, Inc. ("DuraVent") provides this limited lifetime warranty for all of its products with the exception of Ventinox® (lifetime), and PolyPro® (ten years). Subject to the limitations set forth below, DuraVent warrants that its products will be free from defects in material or manufacturing, if properly installed, maintained and used. DuraVent products are fully warranted if installed only by a professional installer. This Warranty is transferable from the original homeowner to the buyer of the home. This warranty does not cover normal wear and tear, smoke damage or damage caused by chimney fires, acts of God, or any product that was: (1) purchased other than from an authorized DuraVent dealer, retailer or distributor; (2) modified or altered; (3) improperly serviced, inspected or cleaned; or (4) subject to negligence or any use not in accordance with the installation instructions included with the product as determined by DuraVent. Installation instructions are available online at www.duravent.com under Support/Literature and through our Customer Service Department 800-835-4429 or customerservice@duravent.com. This limited lifetime warranty applies only to parts manufactured by DuraVent.

DuraVent provides the following warranties for its products: One Hundred Percent (100%) MSRP 15 years from the date of purchase, and Fifty Percent (50%) thereafter, except for the following limitations on: all Termination Caps and DuraBlack® are warranted at One Hundred Percent (100%) for five years.

All warranty obligations of DuraVent shall be limited to repair or replacement of the defective product pursuant to the terms and conditions applicable to each product line. These remedies shall constitute DuraVent's sole obligation and sole remedy under this warranty. This warranty provides no cash surrender value. The terms and conditions of this warranty may not be modified, altered or waived by any action, inaction or representation, whether oral or in writing, except upon the express, written authority of an executive officer of DuraVent.

Corn, bio-fuels, driftwood or other wood containing salt, preservative-treated lumber, plastic and household trash or garbage, or wood pellets containing such materials must not be burned in the appliance or fireplace. In case of a chimney fire, the chimney must be inspected and approved by a certified Chimney Sweep before reuse. After each annual inspection, maintenance, and cleaning, the certified Chimney Sweep must fill out and date the appropriate section of the warranty card provided with the chimney liner.

LIMITATIONS ON INTERNET SALES: Notwithstanding any other terms or conditions of this Limited Lifetime Warranty, DuraVent provides no warranty for the following specific products if such products are not installed by a qualified professional installer: DuraTech®, DuraPlus HTC®, DuraChimney® II, PelletVent Pro®, DirectVent Pro®, FasNSeal®, FasNSeal® W2, FasNSeal® Flex, and PolyPro®, and DuraVent's relining products including DuraLiner®, DuraFlex® (SW, Pro, 316, 304), and Ventinox®. For purposes of this warranty, a trained professional installer is defined as one of the following: licensed contractors with prior chimney installation experience, CSIA Certified Chimney Sweeps, NFI Certified Specialists, or WETT Certified Professionals.

DuraVent must be notified and given the opportunity to inspect defective product prior to replacement under the terms of this limited lifetime warranty. All warranty claims must be submitted with proof of purchase. Labor and installation costs are not covered under this warranty. To obtain warranty service contact: DuraVent Warranty Service, 877 Cotting Ct., Vacaville CA 95688, or call 800-835-4429.

WHERE LAWFUL, DURAVENT DISCLAIMS ALL OTHER WARRANTIES, INCLUDING BUT NOT LIMITED TO IMPLIED WARRANTIES OF MERCHANTABILITY AND FITNESS FOR A PARTICULAR PURPOSE. IN NO EVENT WILL DURAVENT BE LIABLE FOR INCIDENTAL, CONSEQUENTIAL, PUNITIVE OR SPECIAL DAMAGES OR DIRECT OR INDIRECT LOSS OF ANY KIND, INCLUDING BUT NOT LIMITED TO PROPERTY DAMAGE AND PERSONAL INJURY. DURAVENT'S ENTIRE LIABILITY IS LIMITED TO THE PURCHASE PRICE OF THIS PRODUCT. SOME STATES DO NOT ALLOW LIMITATIONS ON IMPLIED WARRANTIES, OR THE EXCLUSION OR LIMITATION OF INCIDENTAL OR CONSEQUENTIAL DAMAGES, SO THE ABOVE LIMITATIONS AND EXCLUSIONS MAY NOT APPLY TO YOU. THIS LIMITED WARRANTY GIVES YOU SPECIFIC LEGAL RIGHTS, AND YOU MAY ALSO HAVE OTHER RIGHTS THAT VARY FROM STATE TO STATE.

For the most up-to-date installation instructions, see www.duravent.com

REV 3.22.2012

Manufactured in Vacaville CA and Albany NY

DuraVent®

Customer Service Support: 800-835-4429 • 707-446-4740 FAX • www.duravent.com

PelletVent® is a registered trademark of M&G DuraVent, Inc.
All rights reserved, ©2012, 2017

L502_820003163_Install Instructions_PelletVent_07-17-17_V2