

45-04921 REPAIR PARTS ILLUSTRATION

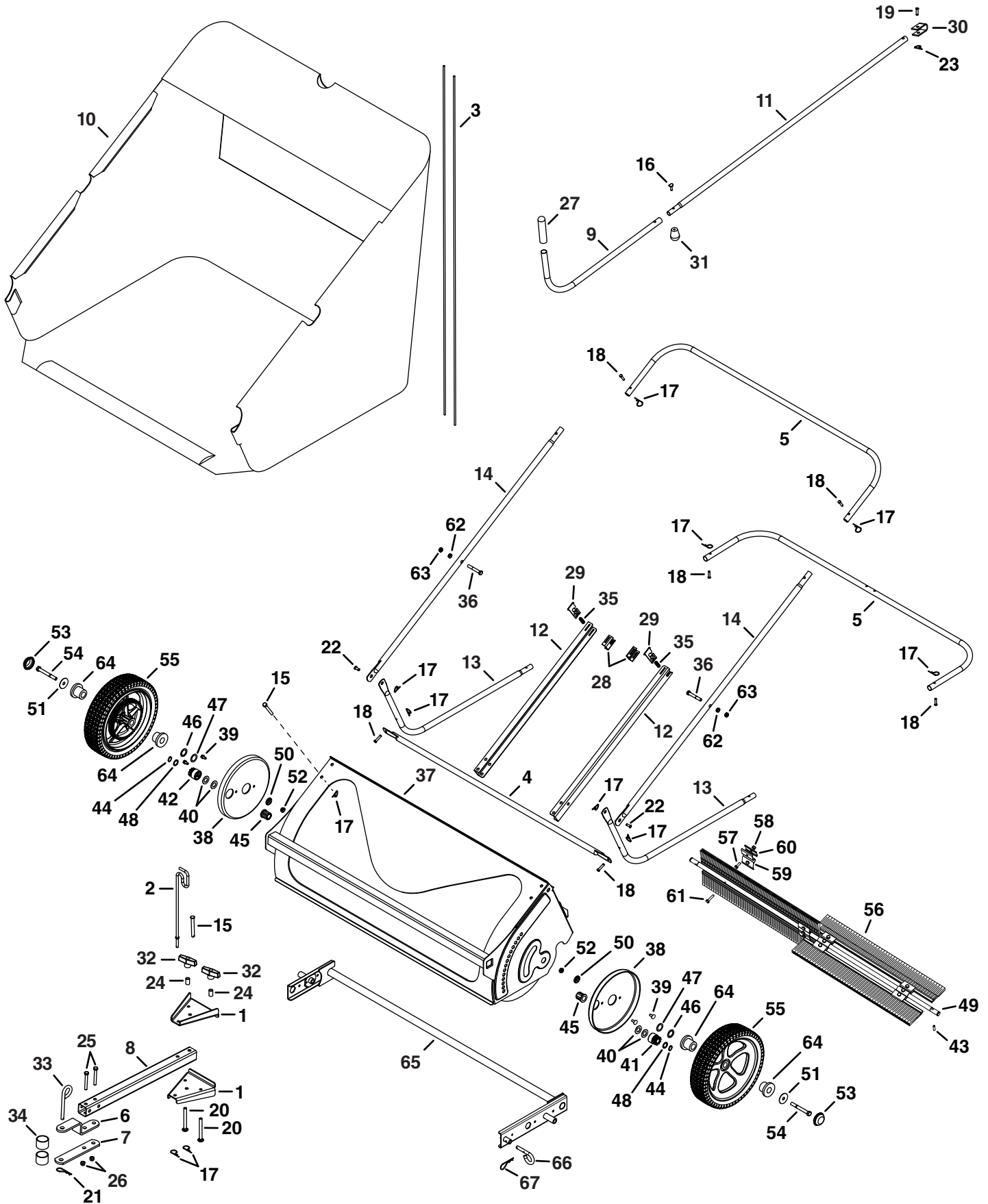

45-04921 REPAIR PARTS LIST

REF	QTY	PART NO	DESCRIPTION	REF	QTY	PART NO	DESCRIPTION
1	2	27425	Drawbar Bracket	35	2	41036	Compression Spring
2	1	42661	Handle Holder	36	2	43432	Hex Bolt, 3/8-16 x 2-1/2"
3	2	42646	Hopper Support Rod	37	1	67634	Sweeper Housing
4	1	42020	Bag Frame Tube	38	2	41035	Dust Cover
5	2	42649	Rear Hopper Tube	39	4	48373	Pop Rivet
6	1	23014	Hitch Bracket	40	4	40001	Shim Washer
7	1	24192	Hitch Bracket (Straight)	41	1	48651	Pinion Gear (LH)
8	1	27421	Drawbar	42	1	48652	Pinion Gear (RH)
9	1	42648	Lower Handle Tube	43	2	47046	Dowel Pin, 1/4 x 3/4"
10	1	42904	Hopper Bag	44	2	42094	Retaining Ring
11	1	42647	Upper Handle Tube	45	2	67407	Bearing Assembly
12	2	27424	Bag Arm	46	2	44008	Washer, 1-1/8"
13	2	40897	Lower Hopper Tube	47	2	1540-31	Washer, 1-1/4"
14	2	42539	Upper Hopper Tube	48	2	42093	Washer, .598"
15	5	HA23636	Clevis Pin, 3/8 x 2-1/4"	49	1	40722	Brush Shaft
16	1	43978	Bolt, 1/4-20 x 1"	50	2	26538	Step Spacer
17	14	43055	Hair Pin, 3/32 x 1.8"	51	2	141	Washer, 1-1/4"
18	6	48365	Clevis Pin, 1/4 x 1.11"	52	2	1038	Nylock Jam Nut, 3/8"
19	1	43259	Clevis Pin, 5/16 x 1-1/4"	53	2	41017	Hub Cap
20	2	44217	Carriage Bolt, 5/16-18 x 3"	54	2	44961	Hex Bolt, 3/8-24 x 3-1/4"
21	1	43343	Hair Cotter Pin, 3/32 x 2-5/16"	55	2	40987	Wheel
22	2	48366	Clevis Pin, 3/8 x 1/2"	56	4	46780	Brush
23	1	HA3090	Hair Cotter Pin, .08 x 1-1/8"	57	8	43012	Hex Bolt, 1/4-20 x 3/4"
24	2	42659	Spacer, 3/4"	58	12	47189	Nylock Nut, 1/4"
25	2	44292	Bolt, Hex 5/16-18 x 2-1/2"	59	4	23580	Brush Retainer (Double)
26	2	47810	Nut, Nylock 5/16-18	60	8	23581	Brush Retainer (Single)
27	1	7071	Handle Grip	61	4	43661	Hex Bolt, 1/4-20 x 1"
28	2	27426	Pivot Rod Support Bracket	62	2	712-3008	Jam Nut, 3/8"
29	2	26484	Pivot Rod Retainer	63	2	42210	Nylock Jam Nut, 3/8"
30	1	23878	U-Clamp	64	4	45088	Wheel Bearing
31	1	42651	Knob	65	1	68539	Height Adjustment Tube
32	2	43720	Wing Knob	66	1	43038	Pivot Lock Pin 3/8"
33	1	23353	Hitch Pin	67	1	48934	Hairpin Agitator
34	2	23368	Spacer		1	40415	Owner's Manual