



TRILINK

PRODUCT KNOWLEDGE GUIDE

PRODUCT INFORMATION ■ MAINTENANCE ■ TROUBLE SHOOTING



TABLE OF CONTENTS

This manual is provided to help you maximize the performance, life and efficiency of your TriLink® Saw Chain by giving you a better understanding of your saw chain, guide bars, and sprockets.

	Certifications	03
SAW CHAIN	Saw Chain Building Blocks	04 - 07
	Understanding Saw Chain	08 - 11
	Maintaining Saw Chain	12 - 15
	Saw Chain Maintenance Errors	16 - 17
	Saw Chain Wear	18 - 19
GUIDE BARS	Understanding Guide Bars	20 - 21
	Guide Bar Building Blocks	22
	Maintaining Guide Bars	23
	Guide Bar Wear	24 - 27
ADDITIONAL INFO	Understanding Sprockets	28
	Sprocket Failure	29
	Kick-Back Prevention	30 - 31
	Reference Guide	32
	Notes	32 - 35

YOUR LINK TO QUALITY

At TriLink[®] Saw Chain we believe that quality is the key to success. Our guide bar and saw chain factory is ISO 9001:2000 certified. This certification gives our customers the confidence that they are buying from a company that is committed to providing quality products and services.

TriLink[®] Saw Chain also offers a complete line of professional saw chain as well as low kickback saw chain that has been tested, approved, and listed by Underwriter's Laboratories to meet all standards for low kickback chain in accordance with the American National Standard Safety Requirements (ANSI B175.1) for gasoline powered chain saws. Our manufacturing facilities are audited quarterly by Underwriter's Laboratories to maintain this listing and your confidence in our products.

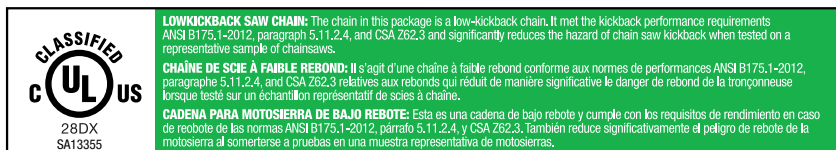

INFORMATION

Clear and concise definitions of chain variations, components, and proper maintenance allow you to get the longest possible life from your saw chain.

MAINTENANCE

TriLink[®] Saw Chain's product knowledge guide will advise you on how to safely and properly extend the life of your saw chain, guide bars, sprockets, and chain components through proper maintenance.

TROUBLE SHOOTING

The safest chain is a sharp chain. Knowing how and when to properly maintain your saw chain and saw chain components will give you their best performance and long lasting component life.

SAFETY SAW CHAIN

Safety Saw Chain incorporates ramped depth gauges to allow smooth high speed cutting while reducing kickback and vibration. Safety saw chain is low kick-back UL tested and approved.

BUMPERLINK SAFETY SAW CHAIN



BUMPERLINK (Safety Drive Link)

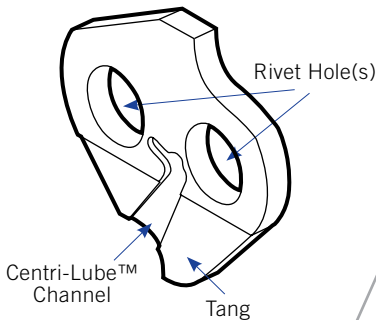

CUTTER TOOTH

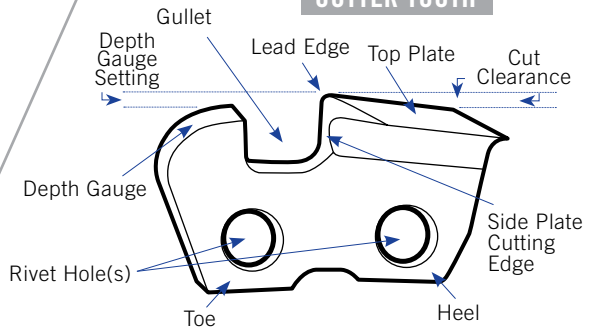

TIE STRAP

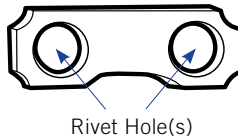

SAW CHAIN

TRILINK™

Saw Chain

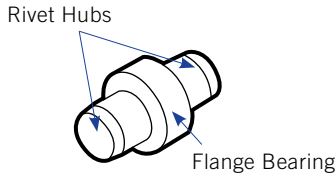

RIVET

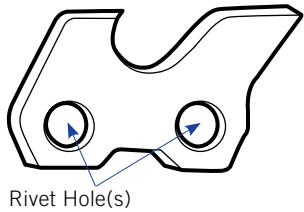
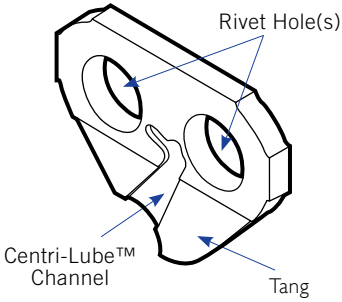

GUARDLINK SAFETY SAW CHAIN

PROFESSIONAL SAW CHAIN

Professional Saw Chain is designed specifically for professional cutters. Professional saw chains are engineered for fast, smooth cutting at high speeds in clean cutting conditions. Professional saw chains are not UL low kick-back tested.

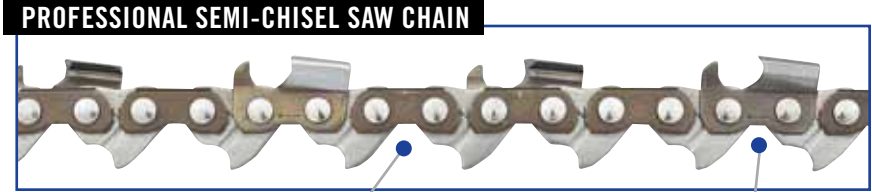

TIE STRAP

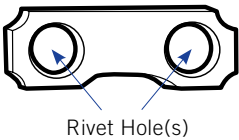

CUTTER TOOTH

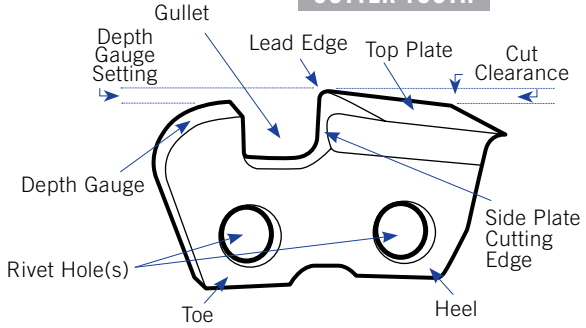

SAW CHAIN

TRILINKTM

Saw Chain

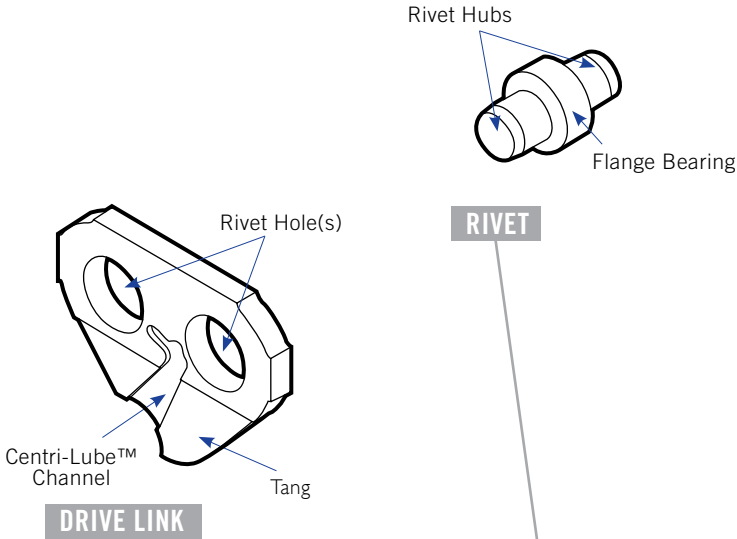

PROFESSIONAL FULL CHISEL SAW CHAIN

UNDERSTANDING SAW CHAIN

PITCH

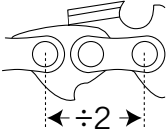

PITCH is determined by measuring the distance between the centers of any 3 consecutive rivets and dividing by two.

GAUGE



GAUGE of a chain is the thickness of the drive link measured at the tang. It's essential that the drive link thickness correctly matches the width of the groove in the guide bar.

KERF

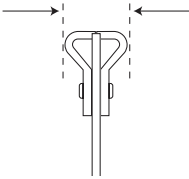

KERF is the width of the cut in the wood made by the saw chain cutter. Optimum kerf for a saw chain is dependent on the chain saw's horsepower, saw chain speed, length of the guide bar and the size, hardness and type of timber being cut. TriLink® saw chain is available with the ideal kerf for every combination of equipment and timber.

SAW CHAIN PITCH

DISTANCE BETWEEN CENTER OF RIVETS

.325" (15.87mm)	5/8" approx.
3/8" LP (19.05mm)	3/4"
3/8" (19.05mm)	3/4"
.404" (20.62mm)	13/16"

CHAIN GAUGES

.043"	1.1mm
.050"	1.3mm
.058"	1.5mm
.063"	1.6mm
.080"	2.0mm

SAW CHAIN

SAW CHAIN SEQUENCES:

There are 3 different sequences of saw chain:

FULL COMPLEMENT CHAIN: One tie strap between each cutter



SEMI SKIP: Chain pattern alternates one tie strap and two tie straps between each cutter



FULL SKIP: Chain has two tie straps between each cutter (half the cutting teeth of full complement chain)



CUTTER STYLES:

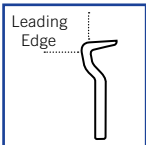

SEMI-CHISEL CUTTERS have a smaller radius than the Chipper Cutter's leading edge allowing it to stay sharper longer and cut faster in dirty and gritty cutting conditions. Ideal for consumer use.

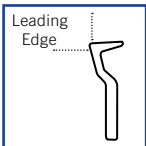

FULL CHISEL CUTTERS are designed for fast, smooth cutting at high-speeds in clean conditions. The square cutter edge is specifically designed to reduce cutting friction for an extremely smooth, clean cut and fast chip clearance. Preferred by professional users.

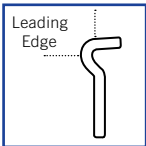

CHIPPER CUTTERS have a larger radius than other leading edges giving the chain a long lasting cutting life, but requiring more power from your chain saw.

UNDERSTANDING SAW CHAIN

CENTRI LUBE™

BETTER LUBRICATION INCREASES THE LIFE OF YOUR CHAIN

Lubrication is the key element in maintaining and extending the life of your chain and guide bar. Lack of proper lubrication develops friction between chain components and the guide bar. This results in decreased cutting performance, lower chain life, and increased stress on engine and drive components. Increased lubrication along the bar and between chain components will increase the life of the chain and provide better cutting performance.

In an effort to enhance cutting performance and chain life, TriLink® Saw Chain has introduced our Centri-Lube™ Oiling System. Centri-Lube™ saw chain has a specially designed channel in each drive link that picks up oil from the bar and distributes it to the rivets that act as bearings on a chain. As the saw chain travels around the bar tip and drive sprocket, centrifugal force moves the oil up this channel and distributes it to the rivets in each link. This reduces friction and heat build-up on the saw chain and guide bar thereby increasing the cutting performance and saw chain life. Your saw chain lasts longer and the job is done faster.

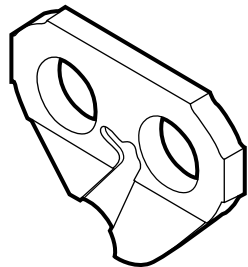

CUTTING MOTION

Understanding how your TriLink® Saw Chain cuts is important in understanding how your chain will wear, the proper manner in which to maintain your chain, and getting the most life out of your chain. When making a cut, the Cutter will catch, rise, roll, and fall as it travels along the guide bar.



The Cutter's leading edge **CATCHES** the wood surface.



The depth gauge sinks into the wood and causes the Cutter to **RISE** off the guide bar.



The cut clearance causes the Cutter to **ROLL** out of the wood surface.



The Cutter **FALLS** back into place along the guide rail.

Saw chain, when performing properly, will cut without needing to apply excessive pressure.

MAINTAINING SAW CHAIN



WARNING!
DULL CHAINS ARE DANGEROUS!

The safest saw chain is a sharp chain. The sharpest chain is a new saw chain. As your saw chain ages and wears, we highly recommend either replacing the saw chain or maintaining and keeping it sharp. TriLink® Saw Chain highly recommends following the manufacturer's recommendations.

SHARPENING CHAIN

Use the correct size file guide and file for your saw chain. Please see the cross reference chart to match the file size to the correct pitch. Improper maintenance and sharpening of saw chain will greatly increase danger of kickback.

SAW CHAIN PITCH	ROUND FILE SIZE
3/8" LP	5/32" (4.0mm)
.325"	3/16" (4.8mm)
3/8"	7/32" (5.5mm)
.404"	7/32" (5.5mm)



SAW CHAIN

TRILINK™

Saw Chain

STEP ONE

Choose correct file size. Be sure file is tightly fit into the guide groove. Then, press the file guide so it rides on both cutter top plate and depth gauge, with guide marks in line with the length of the chain.

FILING GUIDE with THUMBSCREW

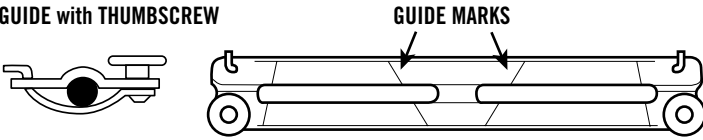

STEP TWO

File all cutters on one side. Move to other side of chain and file all cutters opposite to complete sharpening. File all cutters identically.

All top plates must be filed to the same length.

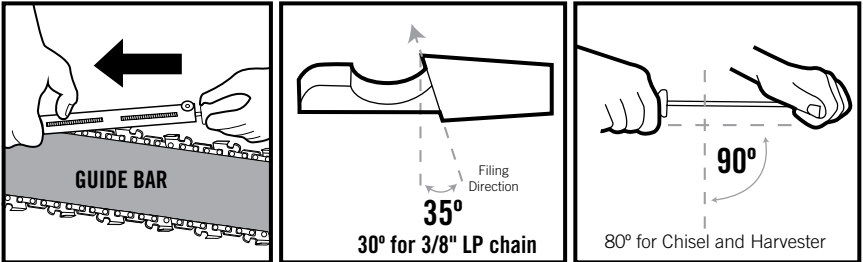

SAW CHAIN PITCH	FILE SIZE	GRINDING ANGLE
3/8" LP	5/32" (4.0mm)	30°
.325"	3/16" (4.8mm)	35°
3/8"	7/32" (5.5mm)	35°
.404"	7/32" (5.5mm)	35°

MAINTAINING SAW CHAIN

CHECKING AND ADJUSTING DEPTH GAUGE

After sharpening a chain's cutters 3 or 4 times with a round file, it is necessary to check the height of the depth gauge.

STEPS:

1. Place depth guide tool over chain, near mid point of guide bar, so that the chain's depth gauge extends through slot.
2. If the cutter's depth gauge extends above the slot in the depth gauge, file the cutter's depth gauge down with flat file until it is level with the depth gauge tool. Make sure to keep the round profile on the front of the cutter's depth gauge.

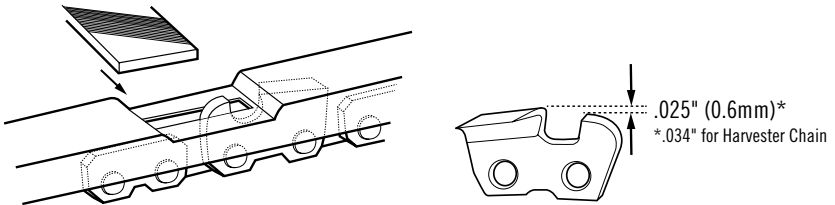

The depth gauge must be filed down, as your leading edge is shortened, to allow the leading edge to catch the cutting surface. A depth gauge that is not maintained will cause insufficient cutting. However, if the depth gauge is filed too low it will cause a rough cut and rise the chances of kickback.

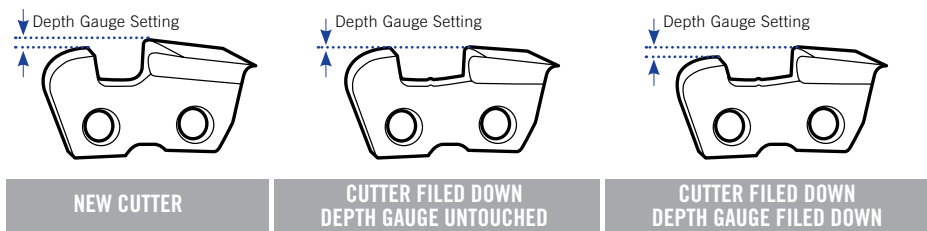

Once cutter has been filed, the leading edge, when viewed from the side, should hook slightly forward (A). The cutting edge at the outermost tip of the top plate should be slanted at 60°. The chain will cut best when all cutters are filed to the same length (B).

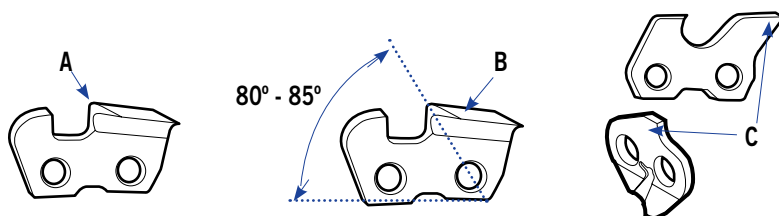

CAUTION: Do not alter guard link tangs (C) except when filing depth gauges. Do not file cutter more than recommended and do not exceed depth gauge clearance. Any deviation from these recommendations will greatly increase the danger of kickback.

SAW CHAIN MAINTENANCE ERRORS

Improper maintenance of saw chain will cause failures in your timber cutting and your saw chain. Most saw chains are not properly maintained and therefore are not used to their full cutting efficiency.

SHARPENING ERRORS

There are several common errors when sharpening your saw chain that will cause failure in your saw chain and shorten your saw chain's life.

One of the most common errors occurs when the leading edge is essentially filed away. This creates what is commonly known as a **BACKSLOPED** cutter. A backslope cutter is caused by filing with a larger file size, or filing too high up on the cutter's leading edge.

Backslope cutters, without a leading edge, will not be able to catch the cutting surface. The natural user reaction when this occurs is to apply more pressure to your chain saw. Applying unnecessary pressure will cause increased wear and possible breakage.

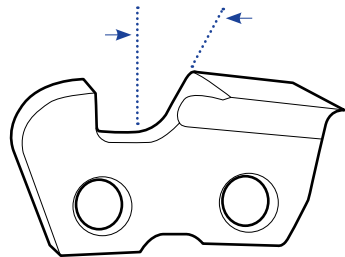

BACKSLOPE CUTTER

The opposite of a backslope cutter is a **HOOKED** cutter. A hooked cutter is caused by filing too far down from the leading edge, or filing with a file size that is too small.

Hooked cutters will catch the surface and your saw chain will cut, however, your chain will dull much quicker. When the chain becomes dull the user's natural response is, again, to apply more pressure which will lead to increased wear and possible breakage.

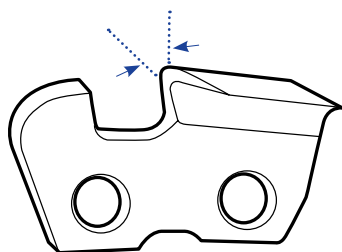

HOOKED CUTTER

Another common problem is the height of **DEPTH GAUGES** either being too high or too low. Filing down the leading edge requires proportionately filing down the depth gauge in order for your saw chain to cut properly.

A depth gauge that is too high will not allow the leading edge to properly catch the cutting surface. A low depth gauge will cause a rough cut and increase the chance of kickback.

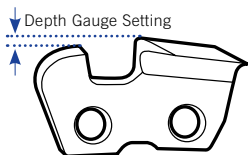

CORRECT DEPTH GAUGE

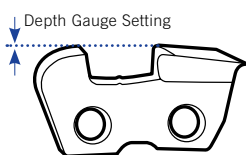

HIGH DEPTH GAUGE

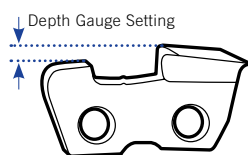

LOW DEPTH GAUGE

SAW CHAIN WEAR

Errors in sharpening your saw chain will increase the wear on your chain, shorten your chain's life efficiency, and increase the possibility of chain breakage.

SIGNS OF SAW CHAIN WEAR

The natural response when a saw chain is not properly cutting is to apply more pressure to your chain saw. The additional applied pressure translates into additional tension, friction, pressure, and heat on saw chain and guide bars.

The additional pressure causes an increase in friction between the guide rail and the bottom of the cutters and tie straps. This additional friction will cause wear on the bottom of your cutters and tie straps (shown in gray).

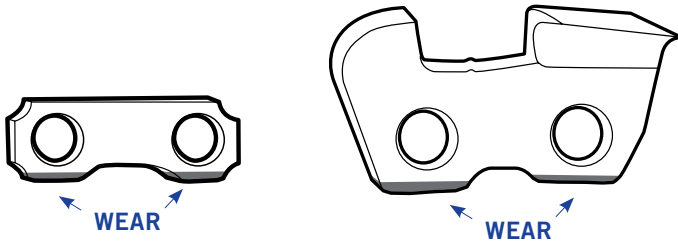

The wear on the bottom of cutters and tie straps can be caused by backsloped cutters and is commonly derived from high depth gauge settings.



TRILINKTM

Saw Chain

Low depth gauges will cause wear on the guide bar rail, however, it will also show wear on the cutters. The wear patterns seen on a cutter from a low depth gauge will begin to show on the heel of the cutter (as shown in gray below) and in time these wear patterns will match the low depth gauge setting.

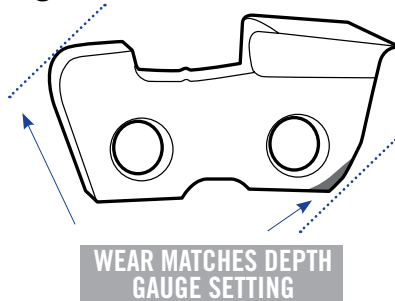

TriLink[®] Saw Chain is industrially chrome plated on the top and side plates of all cutters. The industrial chrome plating helps the leading edge hold its sharpness. When damaged and/or worn, the cutter must be sharpened to restore the chrome edge.

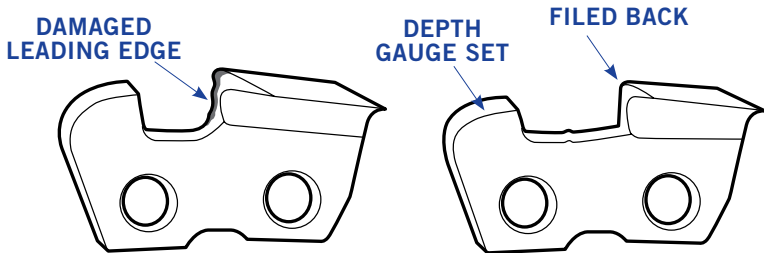

Saw chain wear can lead to breakage. Proper maintenance is highly recommended. Correct procedures for sharpening the cutter and setting the depth gauge correctly can be found in the 'Maintaining TriLink[®] Saw Chain' section of this guide (Pages 12 - 15).

UNDERSTANDING GUIDE BARS

TriLink® Guide Bars are designed to provide a guide and support rail for the moving saw chain. Our guide bar types include: Mini Laminate Sprocket Nose, Laminate Sprocket Nose, Replacement Sprocket Nose and Hard Nose.

GUIDE BAR STYLES



TriLink® **MINI LAMINATE SPROCKET NOSE BARS** have a single bearing inside a rotating sprocket located at the tip of the bar with a single rivet construction. As the chain moves along the bar, the sprocket teeth carry the chain around the tip quickly with little friction or reduction in cutting speed. These bars are available in 6" - 18" configurations. All mini laminate bars will be 3/8" LP pitch.



TriLink® **LAMINATE SPROCKET NOSE BARS** are light weight bars that are typically used on consumer saws for the occasional or semi-professional user. These bars are available in many applications from 11" - 24" and are the best value for the consumer. TriLink® Laminate Sprocket Nose Bars have a rotating sprocket located at the tip of the bar with a sturdy four rivet construction.

GUIDE BARS

TRILINKTM

Saw Chain



TriLink® **REPLACEMENT SPROCKET NOSE BARS** have a solid steel body with a replaceable sprocket nose tip. This tip can be changed as it wears out without having to replace the entire bar. These bars are manufactured for high speed, heavy duty saws and are preferred by the professional and semi-professional cutter; available in 16" - 42" configurations.



TriLink® **SOLID HARD NOSE BARS** are constructed from one solid piece of steel with Stellite™ alloy laser welded onto the tip. Solid nose bars are designed for dirty cutting conditions as they have no moving bearings to get clogged. These bars are also frequently used for bore cutting. TriLink® Solid Hard Nose Bars are typically used by professional cutters because of their extreme strength and durability.

BUILDING BLOCKS OF A GUIDE BAR

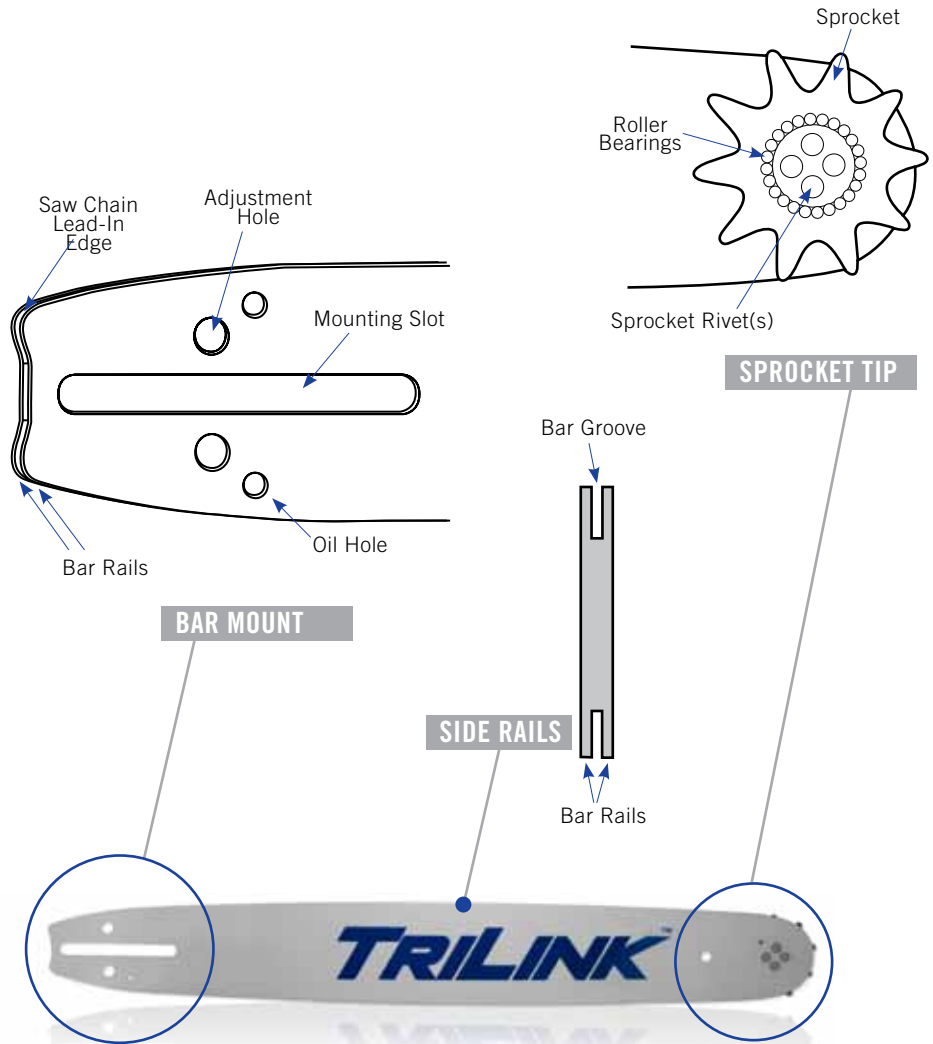

GUIDE BARS

GUIDE BAR MAINTENANCE

There are three major points to remember when maintaining your TriLink® guide bars.

FIRST, inspect the guide rails and oil holes to make sure they are clear of saw dust and dirt. Keeping both the rails and oil holes clean ensures the optimal lubrication.

SECOND, check your guide rail for any imperfections; this can mean burrs, cracking, twisting, or uneven rails. Making sure the guide bar stands on a flat surface will help determine if the rails are straight. Any burrs need to be filed away using a flat file.

THIRD, you should have already cleaned out the saw dust and dirt from the guide rails, now it's time to make sure the drive links of your saw chain will run smoothly in the bar groove. Be sure to check the depth and the straightness of the bar groove.

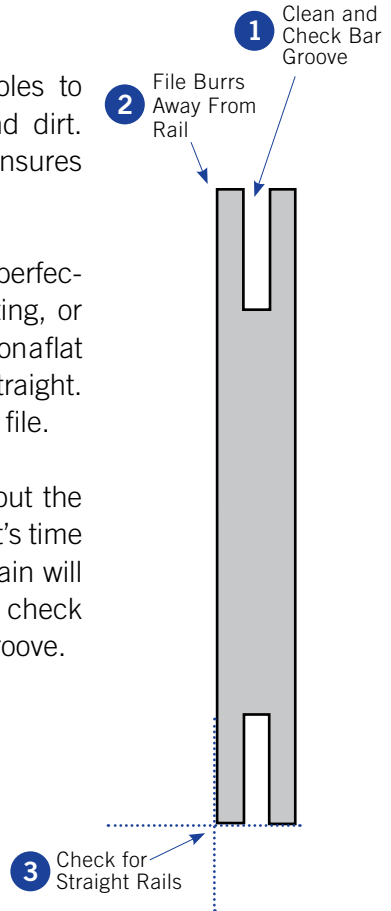

GUIDE BAR WEAR

DAMAGED RAILS

Over time, guide rails may become worn and uneven. These damaged rails will cause your saw chain to cut unevenly through the timber. As the saw chain travels through the guide rails the cutters will pull the saw chain in the direction of its cut. When a cutter is angled to the left it will pull the chain to the left and when angled to the right a cutter will pull the saw chain to the right.

A saw chain that is sharpened and cutting properly will balance out it's natural pull. Saw chains that are improperly sharpened or are running on uneven rails will have uneven pull from the saw chain cutters and will cause more wear on the rails and the bar groove.

Pressure on the guide rails will cause the wire edge rail effect. The wear on the rails, if not filed down, will result in possible chipping or breakage.

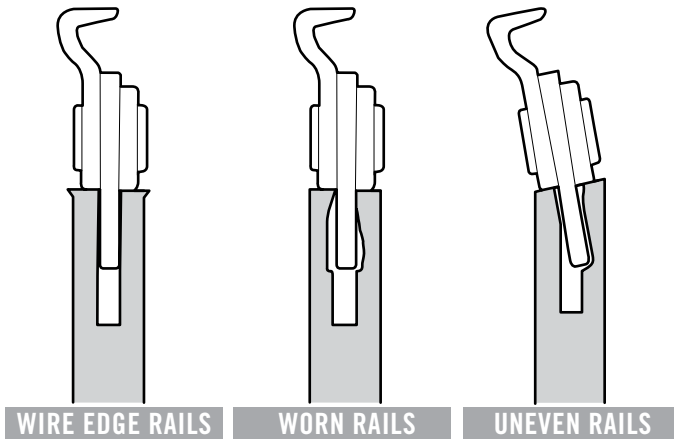

In addition to poor saw chain maintenance, the added pressure and friction of forcing a cut will lead to damage and wear on your guide bar. Heat will continue to build up from the added pressure softening the guide bar rails. The additional pressure from the saw chain on the chain lead-ins will bend the guide bar rails outwards.

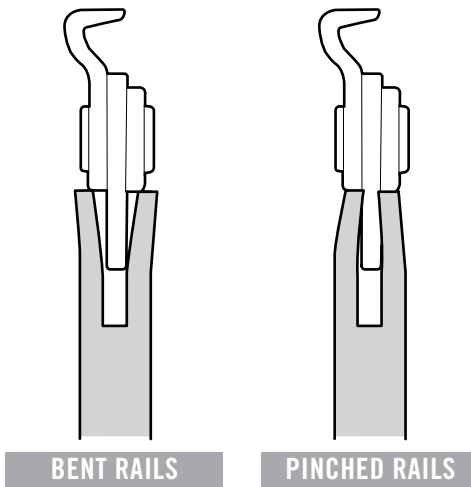

The risk of pinching the guide rails is also high when applying added pressure to your cut. A pinched guide rail will cause your saw chain to catch on the compressed areas resulting in your saw chain binding.

Excessive damage to the guide rails and guide bar (bending, cracking, twisting) will result in needing a replacement bar. Proper maintenance of your saw chain will ensure a longer life for your guide bar, limit the damage and wear to the guide rails, and provide a cleaner, safer cut.

GUIDE BAR WEAR

DAMAGED NOSE

Improper depth gauge settings will cause damage to your guide rails at any location of the guide bar. The nose of a sprocket nose guide bar, though, is susceptible to additional damage and wear. When cutting with a saw chain that has too loose of tension additional material wear will occur.

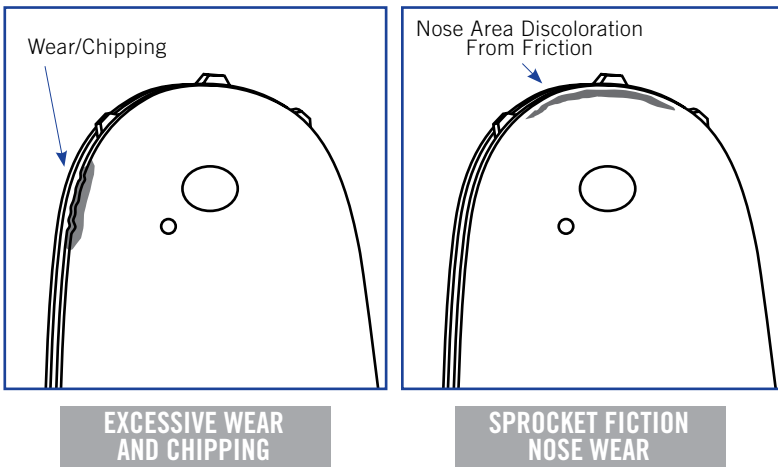

When a saw chain comes free during cutting, due to loose tension, the bar nose may become twisted. A twisted bar nose will not allow the sprocket to turn freely and will result in a replacement guide bar being needed do to excessive damage.

The nose of a guide bar that has been twisted or pinched will create additional friction in and around the sprocket. This additional friction will cause discoloration to the nose area of the guide bar. This excessive damage will result in a replacement guide bar being needed.

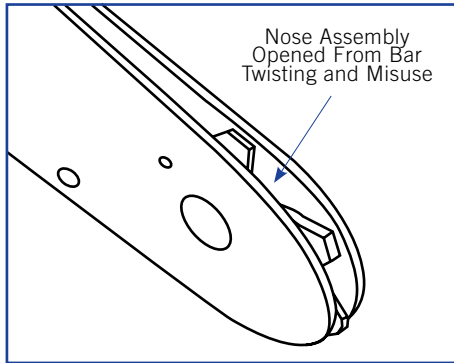

BROKEN SPROCKET NOSE

Misuse of your chain saw, such as using it as leverage to fell a tree or as a felling wedge, as well as cutting while a saw chain's tension is too tight will cause a damaged or possible broken nose sprocket and will result in a replacement guide bar needed.

SPROCKETS

SPROCKETS

Drive Sprockets are as important to your chain saw as the engine and the saw chain. The Sprocket is the stepping block between the power from the engine and the saw chain using centrifugal force to drive the chain.

There are two types of sprockets. **SPUR SPROCKETS** are a machine produced, one-piece solid construction. Spur sprockets incorporate both the clutch drum and the drive sprocket into a single piece.

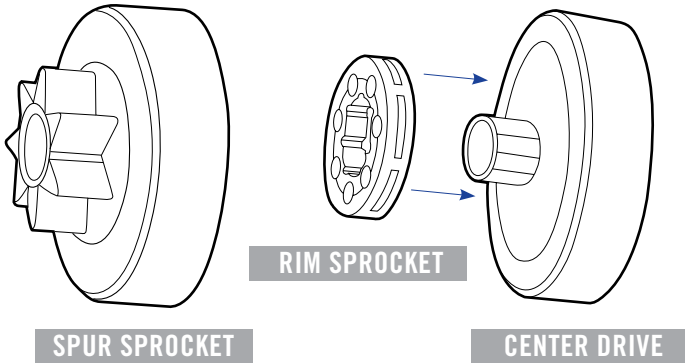

The **RIM SPROCKETS** are a two piece construction that allow the chain to be aligned with the bar groove because the rim rides on the hub splines. The rim sprocket will take the majority of the wear, reducing wear to the center drive sprocket.

Sprockets are a lot like saw chain and guide bars. The pitch of a sprocket must match that of the saw chain and that of the sprocket nose guide bar.



TRILINK™

Saw Chain

As your saw chain wears, naturally, so will your sprocket. When a new chain is placed on a worn out sprocket your new chain will wear quicker, matching the wear of the sprockets and creating a 'stretch' effect in your saw chain. The reality is that this 'stretch' is actually the saw chain trying to fit into the wear on both your sprockets, essentially creating an improper pitch on the sprocket.

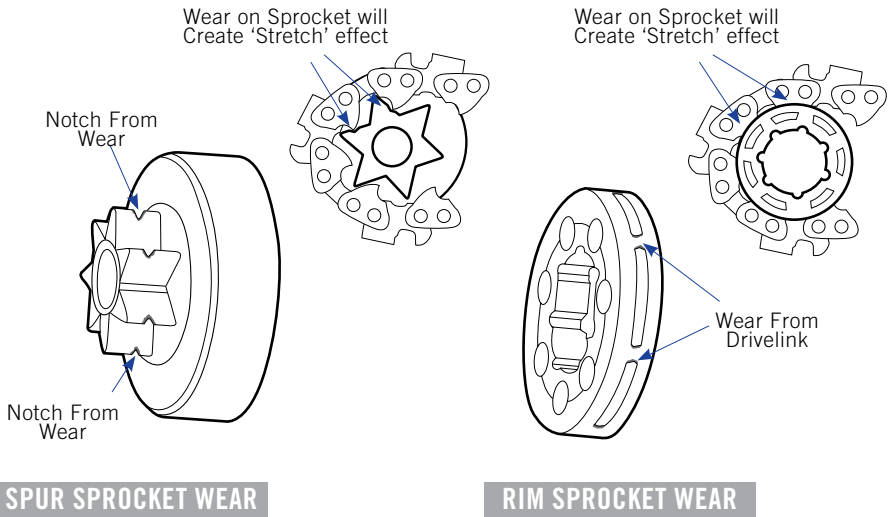

Testing the wear on your sprocket is recommended. Turn off your chain saw when testing your sprocket. Then pull your saw chain around the guide bar with the proper tension applied to the chain. A worn sprocket will make the chain drag and bind up making it difficult to pull around the guide bar.

Once a sprocket is worn it will need to be replaced in order to prevent quicker wear on your saw chain and guide bar.

PREVENTING KICK-BACK

Essentially, TriLink® Saw Chain carries two types of chain: **LOW KICK-BACK** (Safety) and **PROFESSIONAL** chain.

PREVENTING KICK-BACK

Low Kick-Back chains are specifically made to reduce the kick-back energy, however they do not completely eliminate kick-back.

There are two types of kick-back: **LINEAR KICK-BACK** and **ROTATIONAL KICK-BACK**. A clear understanding of both of these will help in reducing kick-back.

Linear Kick-Back is caused when the saw chain and guide bar become pinched at the top of the guide bar during the cut. The pinched chain and bar will cause a strong backward motion (kick-back) as the chain catches in the pinched cut. The use of a felling wedge will prevent the wood surface from pinching the guide bar and allow a smoother, faster cut.

Rotational Kick-Back is caused by the tip of the guide bar and saw chain catching an object and pushing back in an upwards motion (kick-back). A proper cut, one where the user does not lead with the nose, will help prevent rotational kick-back from occurring.

Improperly sharpening or filing of guardlinks will increase the risk of kick-back.



KICK-BACK

CAUTION: Kick-Back can lead to dangerous loss of control of the chain saw and result in serious or fatal injury to the operator and anyone standing close by.

GUARD AGAINST KICK-BACK

ALWAYS use two hands to operate the chain saw. **KEEP** the saw below shoulder height as this gives you, the operator, better control over kick-back reactions. **MAINTAIN** a balanced stance with the left elbow braced as straight as possible and the handles held firmly between the thumb and fingers. **KEEP** a firm grip with both hands at all times.

REV up the engine to full throttle before letting the chain touch the wood. **DO** all your cutting at full throttle; a slow chain can catch the wood and throw the saw from your hands. **DO** all cutting on the straight portions (top and bottom rails) of the guide bar to avoid kick-back reactions. **NEVER** cut with the bar tip.

KEEP watch that the tip of the bar does not contact any object while chain is moving. **KEEP** your chain properly maintained and properly tensioned.

READ your chain saw User Manual and operating instructions before attempting to use the saw. Be sure you understand all instructions. If in doubt, consult your dealer for instructions before using.

NEVER stand directly behind the chain saw while cutting; stand slightly to the left of the guard bar. **NEVER** remove, modify, or make inoperative any safety device or guard provided. **NEVER** start a chain saw using the drop start method.

REMEMBER a chain saw is a very dangerous tool when used improperly.

REFERENCE GUIDE

REFERENCE GUIDE		
CHAIN SAW MAKE		CHAIN SAW MODEL
TRILINK CHAIN PART NO.	TRILINK FILE AND GUIDE SIZE	TRILINK SPROCKET NO.
TRILINK GUIDE BAR PART NO.		

NOTES:



REFERENCE

NOTES:

ADDITIONAL NOTES

NOTES:



REFERENCE

NOTES:



CONTACT:

www.trilinksawchain.com

TriLink Saw Chain, LLC

101 Marietta St. Suite 2425
Atlanta, GA 30303
678.359.4450
1.877.492.9829

TriLink Saw Chain Sales

130 Corridor Road #661
Ponte Vedra Beach, FL 32082
sawchainsales@trilinkglobal.com
904.285.0687

TriLink European Sales

Norrabyvagen 10D
S 57343 Tranas Sweden
bjohansson@trilinkglobal.com
+46-705-521214

TriLink Latin America Sales

Miguel Barreiro 3120
Office 11
Montevideo Uruguay C.P. 11321
598.2.707.0695